



Centroid M-Series Operators Manual

CNC Software version: CNC11 V.3.12

Models: M400 & M39









- Introduction **1-1**
- Operators Panel **2-1**
- Main Screen **3-1**
- Part Setup **4-1**
- Tool Setup **5-1**
- Running a Job **6-1**
- Utility Menu **7-1**
- Digitizing **8-1**
- Probing **9-1**
- Intercon Conversational Programming **10-1**
- CNC Program codes **11-1**
- G- Codes **12-1**
- M code functions **13-1**
- Configuration **14-1**
- CNC Software Messages **15-1**

**READ THIS MANUAL BEFORE USING THIS PRODUCT.
FAILURE TO FOLLOW THE INSTRUCTIONS AND SAFETY
PRECAUTIONS IN THIS MANUAL CAN RESULT IN
SERIOUS INJURY OR DEATH.**

All operators and service personnel must read this manual before operating CENTROID CNC control equipment and all connected machine tools.

Keep this manual in a safe location for future reference.

Throughout this manual and on associated products where applicable, in accordance with ANSI Z535, the following symbols and words are used as defined below:

 DANGER	“DANGER” with or without a red background = Hazard WILL cause death or serious injury if ignored.	 DANGER
 WARNING	“WARNING” with or without an orange background = Hazard COULD cause death or serious injury if ignored.	 WARNING
 CAUTION	“CAUTION” with or without a yellow background = Hazard MAY cause minor to moderate injury if ignored.	 CAUTION
NOTICE	“NOTICE” with or without a blue background = Indicates an action to prevent damage to the product or other materials used with product.	 NOTICE

Information provided by CENTROID relating to wiring, installation, and operation of CNC components is intended as only a guide, and in all cases a qualified technician and all applicable local codes and laws must be consulted. CENTROID makes no claims about the completeness or accuracy of the information provided, as it may apply to an infinite number of field conditions.

As CNC control products from CENTROID can be installed on a wide variety of machine tools NOT sold or supported by CENTROID, **you MUST consult and follow all safety instructions provided by your machine tool manufacturer regarding the safe operation of your machine and unique application.**

CENTROID CNC controls provide facilities for a required Emergency Stop circuit which can be used to completely disable your machine tool in the event of an emergency or unsafe condition. **Proper installation of your CNC control MUST include the necessary wiring to disable ALL machine tool movement when the Emergency Stop button is pressed.** This includes machine, servo motors, tool changers, coolant pumps, and any other moving parts. DO NOT disable or alter any safety feature of your machine or CNC control.



Never alter or remove any safety sign or symbol from your machine or CNC control components. If signs become damaged or worn, or if additional signs are needed to emphasize a particular safety issue, contact your dealer or CENTROID.

CNC Control Operating Specifications

	Minimum	Maximum
Operating Temperature	40°F (5°C)	104°F (40°C)
Ambient Humidity	30% relative, non-condensing	90% relative, non-condensing
Altitude	0 Ft. (Sea Level)	6000 Ft. (1830m)
Input Voltage (110, 220, 440 VAC, System Dependent)	-10% of Specified System Input Voltage	+10% of Specified System Input Voltage

Note: Your machine may have operating conditions different than those shown above. Always consult your machine manual and documentation.

Safety signs and labels found on your machine tool, and on CNC system components typically follow the following examples:

Warning Symbol	Hazard Severity Level & Word Message	Action Symbol
	 High Voltage Electrocution Hazard. Death by electric shock can occur. Turn off and lock out system power before servicing.	
The warning symbol identifies the potential hazard and reinforces the word message.	The severity level is one of “DANGER”, “WARNING”, “CAUTION”, or “NOTICE”. Word message includes 3 parts: hazard, consequence if warning is ignored, and action to prevent injury.	Indicates actions to prevent injury. Blue circles indicate mandatory actions to avoid harm. Red circles with diagonal slashes indicate prohibited actions to avoid harm.

CNC Machine Tool Safety

- All machine tools contain hazards from rotating parts; movement of belts, pulleys, gears, and chains; high voltage electricity; compressed air; noise; and airborne dust, chips, swarf, coolant, and lubricants. Basic safety precautions must be followed to reduce the risk of personal injury and property damage.
- Your local safety codes and regulations must be consulted before installation and operation of your machine and CENTROID CNC control. Should a safety concern arise, always contact your dealer or service technician immediately.
- Access to all dangerous areas of the machine must be restricted while the machine is in use. Ensure that all safety guards and doors are properly in place during use. **Automatically controlled machine tools may start, stop, or move suddenly at any time. Do not enter the machining area when the machine is in motion; death or severe injury may result.**
- Personal protective equipment, particularly ANSI-approved impact safety glasses and OSHA-approved hearing protection must be used. Proper handling, storage, use, and disposal of materials in accordance with manufacturer's instructions and Material Safety Data Sheets (MSDS, or your local equivalent) must be followed.
- DO NOT operate your machine or CNC control in explosive atmospheres or in environmental conditions outside of the manufacturer's specified ranges. Electrical power must meet the specifications provided by your machine and CNC control manufacturer.
- DO NOT operate your machine or CNC control if any safety systems are damaged or missing. Excessively scratched or damaged windows and guards must be replaced.
- ONLY authorized personnel should be allowed to operate the machine and CNC control. Improper operation can cause injury, death, and machine or control damage, and may void applicable warranties.
- All electrical enclosures and panels MUST be closed and secured at all times except during installation and service. Only qualified electricians and service personnel should have access to these locations. Hazards arising from high voltage electricity and heat exist in the control cabinet, and may exist even after the main disconnect is turned OFF.
- Improperly clamped or fixtured parts; improperly secured tooling; and broken parts, fixtures, and tooling resulting from machining operations at unsafe feedrates and speeds may result in projectiles being ejected from your machine, even through safety systems such as guards and doors. Always follow safe and reasonable machining practices and follow all safety precautions provided by your tooling and machine manufacturer.
- Ultimate responsibility for safe operation and maintenance of your machine and CNC control rests with shop owners and machine operators. Before performing any work or maintenance all individuals should be thoroughly acquainted with the safe operation of BOTH machine tool AND CNC control.
- Shop owners and operators are responsible for ensuring that shop and machine safety systems such as Emergency Stop and fire suppression systems are present and functioning properly, as required by local codes and regulations.

CNC Control Warning Labels



High Voltage Electrocutation
Hazard.

Death by electric shock can occur.
Turn off and lock out system power before
servicing.



High Voltage Electrocutation
Hazard.

Death by electric shock can occur.
Turn off and lock out system power before
servicing.

TABLE OF CONTENTS

CHAPTER 1 - Introduction

Window Description	1-1
Conventions	1-3
Machine Home	1-4
Mill M and G Codes	1-5
Software Unlocks	1-6

CHAPTER 2 - Operator Panels

M-Series Jog Panel	2-1
Keyboard Jog Panel	2-5
Keyboard Shortcut Keys	2-7

CHAPTER 3 – CNC Software Main Screen

Option Descriptions	3-1
---------------------	-----

CHAPTER 4 - Part Setup

Operation Description	4-2
Part Setup Examples	4-4
Work Coordinate Systems Configuration	4-6
Coordinate Systems Rotation	4-7
Transformed WCS	4-8

CHAPTER 5 - Tool Setup

Offset Library	5-1
Automatic Tool Measurement	5-3
Setting up Tool Height Offsets	5-4
Tool Library	5-5
Tool Life Management	5-7

CHAPTER 6 – Running a Job

Job Run Screen with G-code Display	6-1
Run-Time Graphics	6-2
Canceling a Job in Progress	6-2
Resuming a Canceled Job	6-3
Run Menu	6-3
Power Feed	6-5

CHAPTER 7 - The Utility Menu

F2 – Update, F3 – Backup, F4 – Restore	7-1
F5 - File Ops.	7-2
F6 – User Maint, F7 – Report	7-3
F8 – Options, F9 – Logs	7-3

CHAPTER 8 – Digitize

Grid Digitize	8-2
Radial Digitize	8-6
Contour Digitize	8-10
Wall Following Digitizing	8-13
Dig to CAD	8-15

CHAPTER 9 - Probing

Part Setup with Probing	9-1
Calibrating the Probe Tip Diameter	9-2
Probing Cycles	9-2
Probe Parameters	9-7
DSP Probe Parameters	9-8

CHAPTER 10 - Intercon Software

Intercon Main Screen	10-1
File Menu	10-2
Rapid Traverse	10-7
Linear Mill	10-8
Arc Mill	10-10
Tool Functions	10-12
Canned Cycles	10-13
Drilling	10-16
Chip Breaking	10-17
Deep Hole Drilling	10-19
Boring	10-20
Tapping	10-22
Facing	10-24
Rectangular Pocket	10-25
Circular Pocket	10-27
Rectangular/Circular Frame Milling	10-29
Thread Milling	10-31
Cleanout	10-33
Subprograms	10-36
Repeat to Depth	10-38
Repeat	10-39
Mirror	10-40
Rotate	10-41
Graphics	10-42
Math Help	10-45
Importing DXF files	10-52
Intercon Tutorials	10-59

CHAPTER 11 – CNC Program Codes

Miscellaneous CNC Program Symbols	11-1
User and System Variables	11-5
Advanced Macro Statements	11-8

CHAPTER 12 - G-codes

G-Code Quick Reference	12-1
G-Code Descriptions	12-2

CHAPTER 13 - M functions

M function Quick Reference	13-1
Customizable M functions	13-2
M function Descriptions	13-3

CHAPTER 14 – Configuration

Password	14-1
Control Configuration	14-2
User Specified Paths	14-3
Machine Configuration	14-4
Machine Parameters	14-8
PID Menu	14-42
DSP Probe Configuration	14-45
Smoothing	14-47

CHAPTER 15 – CNC Software Messages

CNC Software Message Descriptions	15-1
-----------------------------------	------

Chapter 1

Introduction

Window Description

The CNC software display screen is separated into five areas called windows. A sample screen is shown below for reference. The five windows are the DRO display window, the status window, the message window, the options window, and the user window. The information that each window displays is described in detail in the following sections.

The screenshot shows a CNC software interface with the following components:

- DRO Display Window:** Shows current position in inches for axes X, Y, Z, A, and B. X is -0.2303, Y is -0.3602, Z is -0.2000, A is +0.0000, and B is +0.0000.
- Status Window:** Displays job information: Job Name: flange.cnc, Tool: T1 H1, Program # 10000, Feedrate: 8.6 ipm, Spindle: 0 M, Coolant, Part #: 0, and Time: 0:00:28.
- Message Window:** Shows a status message: Processing... Moving... Press ESC to cancel.
- User Window:** Lists 'Dist to Go' for each axis and the corresponding G-code block numbers (26-36).
- Options Window:** Contains function key shortcuts: Feed -1% (F1), Feed +1% (F2), Repeat On (F3), /Skips On (F4), Feed Hold (F7), and Rapid On (F9).

DRO display

The DRO display contains the digital read out of the current position of the tool. The display is configurable for number of axes and desired display units of measure (see Chapter 14). The bars under each axis are the load meters and represent the amount of power being supplied to the drive for that axis. The display of axis load meters is configured by machine parameter 143 – see Chapter 14 for specific information.

Distance to Go DRO

The distance to go DRO is located below the main DRO. This display shows the distance to go to complete the current movement. The display of distance to go is controlled by parameter 143. See Chapter 14 for details. See also “Hot Keys” in chapter 2.

Status window

The first line in the status window contains the name of the currently loaded job file. Below the job name are the Tool Number, Program Number, Feedrate Override, Spindle Speed, and Feed Hold indicators. The Feedrate Override indicator displays the current override percentage set on the Jog Panel. The Feedrate label will turn RED if the rapid override is turned off. If your machine is equipped with a variable frequency spindle drive (inverter), the Spindle indicator will display the current spindle speed. The Feed Hold indicator displays the current status (on/off) of FEED HOLD. See Chapter 2 for descriptions of the Feed Hold Button, Feedrate Override Knob, and Spindle controls. For a description of the Program Number see G65 in Chapter 12 or M98 in Chapter 13.

The Part Cnt and Elapsed Time indicators appear when CYCLE START is pressed while a job is running. The Part Count indicator displays the number of times the currently loaded job has been run. They count increments by one after the completion of a run. If a job is canceled prematurely, the part count will not be incremented. The Part # counter shows the how many parts have been run, with an up/down arrow displayed to indicate the counting direction. See the run menu for more information on the Part Cnt and Part # setting.

The Part Time indicator displays how much time has passed since the CYCLE START button was pressed. The indicator will help you to determine how long it takes to mill a particular part. The timer will not stop until the job is canceled. It will continue to count for optional stops, tool changes, FEED HOLD, etc.

Message window

The message window is divided into a message section and a prompt section. The prompt section of the window is the lowest text line in the window and will display prompts to the user. For example, the prompt 'Press CYCLE START to start job' is displayed on the prompt line after power-up.

The message section is the top four text lines of the message window. This section will display warnings, errors, or status messages. The newest messages always appear on the lowest of the four lines. Old messages are shifted up until they disappear off the top of the message window. When old messages scroll out of view, a scroll bar will appear on the right side of the window. When the scroll bar is visible you may use the up and down arrow keys to view older messages. See Chapter 15 for a description of the CNC software error and status messages.

Options window

Options are selected by pressing the function key indicated in the box. For example, on the main screen, pressing the function key **F5 - CAM** selects the CAM option.

User window

The information contained in this window is dependent upon on the operation the user is performing on the control. If no action is being taken, the window is empty.

For instance, when the **CYCLE START** button is pressed and a job is processed correctly, up to 11 lines of G codes will be displayed in this window for the user to observe during the Run of the part. All of the part zeros, the tool library setup, and the Digitizing/Probing information are entered in by the user in this window.

Conventions

*Bold capitalized characters represent keystrokes. For example, the A key is written as **A**, and the enter key is written as **ENTER**. The "Escape" key is written as **ESC**. Key combinations such as **ALT-D** mean that you should press and hold **ALT** then press **D**.

*All data entry screens in the M-Series Control use **F10** to save changes.

*Any menu in the M-Series Control can be exited by pressing **ESC**. This will take you back to the previous menu. This also usually discards any changes you have made in that menu.

*All program examples and software use the standard Cartesian coordinate system (see the figure below). If you are facing the mill, the X-axis is defined positive to your right; the Y-axis is defined positive to the mill; and the Z-axis is defined positive upward, perpendicular to the XY plane.

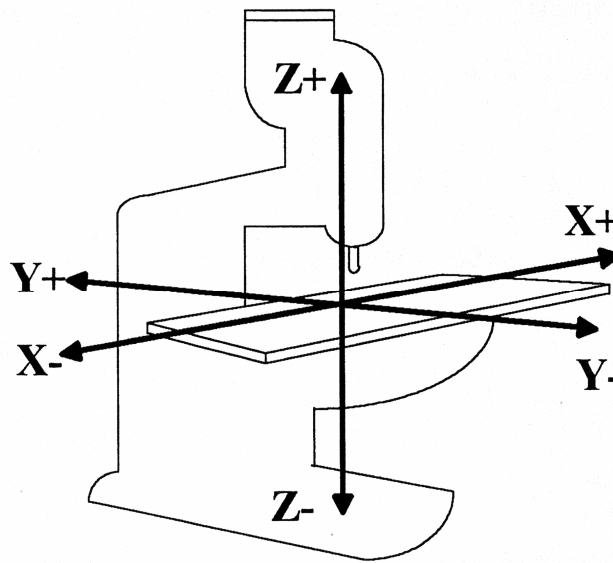

*The direction of motion is defined by the CUTTER motion, not the TABLE motion.

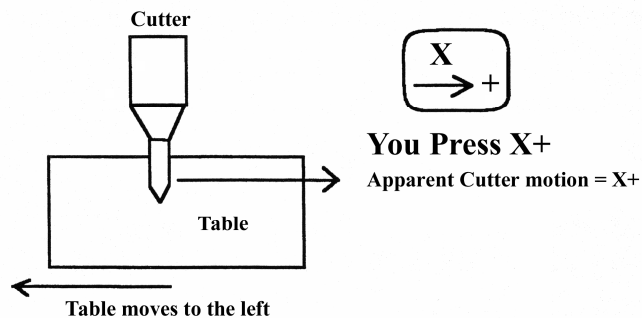

*CW stands for clockwise, and CCW stands for counterclockwise.

Machine Home

When the M-Series control is first started, the Main screen will appear as below.

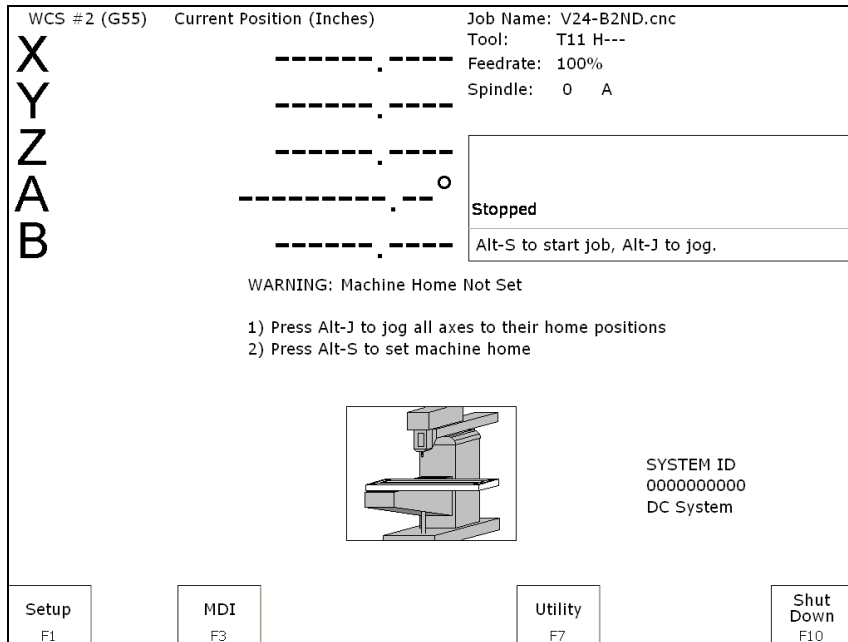

Before you can run any jobs, you must set the machine home position. If your machine has home/limit switches, reference marks or safe hard stops, the control can automatically home itself. If your machine has reference marks, jog the machine until the reference marks are lined up, (see below), before you press **CYCLE START** to begin the automatic homing sequence. The control will execute the G-codes in a file called cncm.hom in the c:\cncm directory. By default, this file contains commands to home Z in the plus direction, then X in the minus and Y in the plus direction.

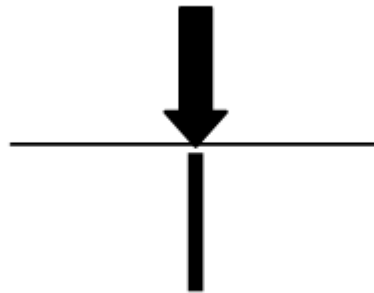

Typical Reference Marks

If your machine does not have home/limit switches or safe hard stops, the following message will appear instead.

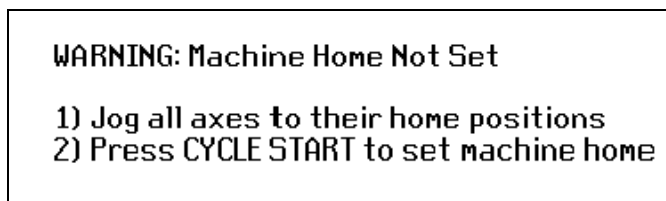

In this case you must move the machine to its home position yourself, using either the jog keys or the handwheels. Once all axes are at their home positions, press **CYCLE START** to set machine home.

Mill M and G Codes

This is a summary list of M and G codes. See Chapters 12 – 13 for more information.

M00 Stop for Operator	G00 - Rapid to Position
M01 Optional Stop for Operator	G01 - Linear Move
M02 Restart Program	G02/G03 - CW/CCW Arc Move
M03 Spindle On Clockwise	G04 - Dwell
M04 Spindle On Counterclockwise	G09 - Decel and Stop
M05 Spindle Stop	G10 - Set Parameter
M06 Tool Change	G17/G18/G19 - XY/ZX/YZ Plane Selection
M07 Mist Coolant On	G20 - Inch Units
M08 Flood Coolant On	G21 - Metric Units
M09 Coolant Off	G22 - Work Envelope On
M10 Clamp On	G23 - Work Envelope Off
M11 Clamp Off	G28 - Return to Reference Point
M25 Move to Z Home	G29 - Return from Reference Point
M26 Set Axis Home	G30 - Return to Secondary Reference Point
M30 Customizable M-code for End of Intercon Program	G40 - Cancel Cutter Compensation
M39 Air Drill	G41/G42 - Cutter Compensation Left/Right
M91 Move to Minus Home	G43/G44 - Tool Length Compensation +/-
M92 Move to Plus Home	G49 - Cancel Tool Length Compensation
M93 Release/Restore Motor Power	G50 - Cancel Scaling / Mirroring
M94,M95 Output On/Off	G51 - Scaling / Mirroring
M98 Call Subprogram	G52 - Offset Local Coordinate System Origin
M99 Return from Macro or Subprogram	G53 - Rapid Positioning in Machine Coordinates
M100 Wait for PLC bit (Open, Off, Reset)	G54-G59 - Select Work Coordinate System
M101 Wait for PLC bit (Closed, On, Set)	G61 - Modal Decel and Stop
M102 Restart Program	G64 - Smoothing Mode Selection / Cancel Modal Decel and Stop
M103 Programmed Action Timer	G65 - Call Macro
M104 Cancel Programmed Action Timer	G68 - Rotate
M105 Move Minus to Switch	G69 - Cancel Rotate
M106 Move Plus to Switch	G73 - High Speed Peck Drilling (Canned Cycle)
M107 Output BCD (Binary Coded Decimal) Tool Number	G74 - Counter Tapping (Canned Cycle)
M108 Enable Override Controls	G76 - Fine Bore (Canned Cycle)
M109 Disable Override Controls	G80 - Cancel Canned Cycle
M115,M116,M125,M126 Protected Move Probing	G81 - Drilling and Spot Drilling (Canned Cycle)
M120 Open data file (overwrite existing file)	G82 - Drill with dwell (Canned Cycle)
M121 Open data file (append to existing file)	G83 - Deep hole drilling (Canned Cycle)
M122 Record local position(s) in data file	G84 - Tapping (Canned Cycle)
M123 Record value and/or comment in data file	G85 - Boring (Canned Cycle)
M124 Record machine position(s) in data file	G89 - Boring with dwell (Canned Cycle)
M127 Record Date and Time in a data file	G90 - Absolute Positioning Mode
M128 Move Axis by Encoder Counts	G91 - Incremental Positioning Mode
M129 Record Current Job file path to data file	G92 - Set Absolute Position
M130 Run system command	G93 - Inverse Time Feedrate Mode
M200/M201 Stop for Operator, Prompt for Action	G94 - Cancel Inverse Time Feedrate Mode
M223 Write Formatted String to File	G98 - Initial Point Return
M224 Prompt for Operator Input Using Formatted String	G99 - R Point Return
M225 Display Formatted String for A Period of Time	G117/G118/G119 - XY/ZX/YZ Plane Selection & Rotation
M300 Fast Synchronous I/O update	G173,G174,G176,G181,G182,G183,G184,G185,G189
M1000-M1015 Graphing Color for Feedrate movement	- Compound Canned Cycles
	G180 - Cancel Canned Cycle

How to unlock software features or unlock your Control

The following are necessary to unlock software features:

1. If you are at the "Demo mode expired" screen, start at step 4.
2. Go to the Main screen of the Control software.
3. Press **F7** "Utility" and then **F8** "Option"
4. Press **F1** "Unlock Option". (You may need to enter the password – usually 137)
5. Next, type in the Unlock # and press **ENTER**.
6. Then, type in the Unlock Value and press **ENTER**.
7. Repeat step 4, 5, and 6 for each new Unlock.

Chapter 2

Operator Panel

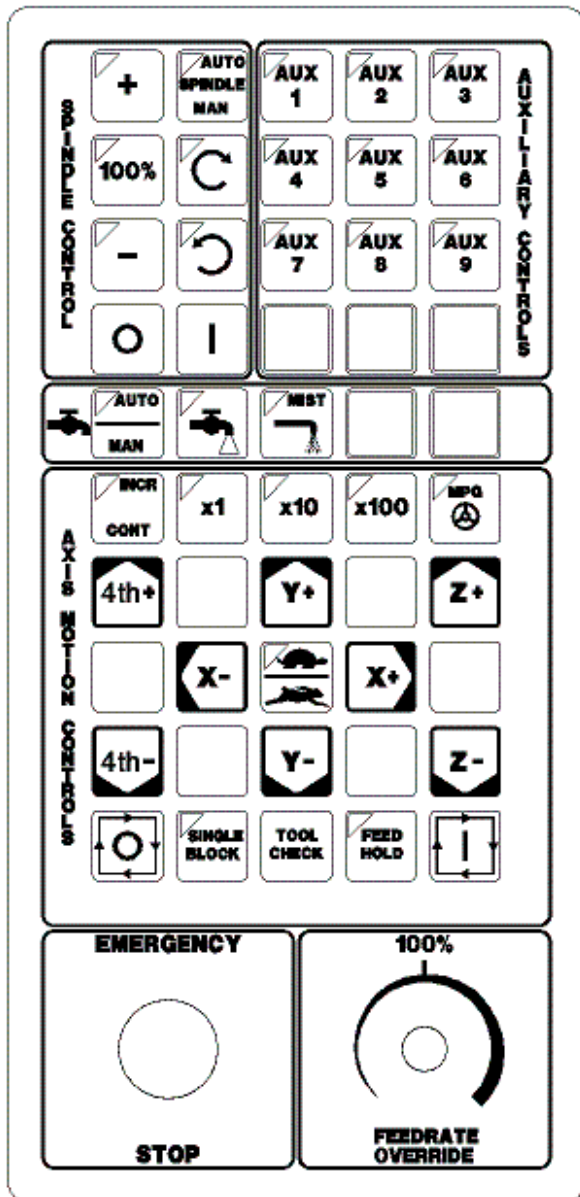

Fig 1 - M-Series Jog Panel

The M-Series operator panel is a sealed membrane keyboard that enables you to control various machine operations and functions. The panel contains momentary membrane switches. The M-Series jog panel can be customized as to the location of various keys. The jog panel displayed in the figure above is representative of a default configuration found on most M-series controls.

Axis Jog Buttons

X+ X- Y+ Y- Z+ Z- 4TH+ 4TH-

The yellow X, Y, Z, and 4TH keys are momentary switches for jogging each of the four axes of the machine. There are two buttons for each axis (+/-). Only one axis can be jogged at a time.

* NOTE: The jog buttons will not operate if the M-Series CNC software is not running, or if a job (a CNC program) is running.



Slow/Fast

The **slow/fast** key is located in the center of the Axis Motion Controls section and is labeled with the turtle and rabbit icon shown to the right. The turtle represents slow jogging mode. When SLOW jog is selected (LED on) and a jog button is pressed, the axis moves at the slow jog rate. If FAST jog is selected, the axis will move at the fast jog rate. See Chapter 14 for information on setting the fast and slow jog rates for each axis.

Inc/Cont

INC/CONT selects between incremental and continuous jogging. Pressing the key will toggle between these two modes. The LED is lit when INC is selected. If CONT jog is selected and an axis jog button is pressed, the axis will move continuously until the button is released.

x1, x10, x100

Press any one of these keys to set the jog increment amount. The amount you select is the distance the control will move an axis if you make an incremental jog (x1=0.0001", x10=0.0010" and x100=0.0100"). You may select only one jog increment at a time, and the current jog increment is indicated by the key that has a lit LED. The jog increment you select is for all axes; you cannot set separate jog increments for each axis. The jog increment also selects the distance the control will move an axis for each click of the MPG handwheel.



MPG

The MPG is housed in a separate hand-held unit. Press the **MPG** key to set the control jog to respond to the MPG hand wheel, if equipped. When selected, the LED will be on. Select the Jog Increment and desired axis and slowly turn the wheel. When the LED is not lit, the MPG is disabled and the jog panel is on.

Single Block

The **SINGLE BLOCK** key selects between auto and single block mode. When the **SINGLE BLOCK** LED is on, the single block mode has been enabled. Single Block mode allows you to run a program line by line by pressing **CYCLE START** after each block. While in block mode you can select auto mode at any time. While in auto mode and a program is running you cannot select single block mode. Auto mode runs the loaded program after **CYCLE START** is pressed. Auto mode is the default (LED off).

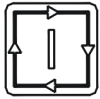

Cycle Start

When the **CYCLE START** button is pressed, the M-400/M-39 Control will immediately begin processing the current program at the beginning and will prompt you to press the **CYCLE START** button again to begin execution of the program. After an M0, M1, M2, or M6 is encountered in the program, the message “Press **CYCLE START** to continue” will be displayed on the screen, and the M-400/M-39 Control will wait until you press the **CYCLE START** button before continuing program execution.



WARNING Pressing **CYCLE START** will cause the M-Series Control to start moving the axes immediately without further warning. Be certain that you are ready to start the program when you press this button. Pressing the **FEED HOLD** button or the **CYCLE CANCEL** button will stop any movement if **CYCLE START** is pressed accidentally.

Feedrate Override

This knob controls the percentage of the programmed Feedrate that you can use during feedrate cutting moves: lines, arcs, canned cycles, etc. This percentage can be from 0% to 200%.



CAUTION The Feerate Override knob will not work during tapping cycles (G74 and G84).

Feed Hold

Feed Hold decelerates motion of the current movement to a stop, pausing the job that is currently running. Pressing **CYCLE START** will continue the movement from the stopped location.



CAUTION **FEED HOLD** is temporarily disabled during tapping cycles (G74 and G84) and automatic tool changes (M6).

Tool Check

Press **TOOL CHECK** while no program is running to move the Z-axis to its home position/G28 position. Press **TOOL CHECK** while a program is running to abort the currently running program. The control will stop normal program movement, pull Z to its home position, clear all M-functions, and automatically display the Resume Job Screen. From the Resume Job Screen, you can change tool settings (height offsets, diameter offsets, etc.) and resume the job with the new tool settings.



Cycle Cancel

Press **CYCLE CANCEL** to abort the currently running program. The control will stop movement immediately, clear all M-functions, and return to the Main Screen. It is recommended that you press **FEED HOLD** first before **CYCLE CANCEL**. If you press **CYCLE CANCEL**, program execution will stop; if you wish to restart the program you must rerun the entire program or use the search function. See search function operation in Chapter 3 or Chapter 6.

Emergency Stop

EMERGENCY STOP releases the power to all the axes and cancels the current job immediately upon being pressed. **EMERGENCY STOP** also resets certain faults if the fault condition has been fixed or cleared.



WARNING

On some machines, vertical axes (such as Z and/or W) may start to move due to gravity pulling it down when motor power is cut due to **EMERGENCY STOP** being pressed.

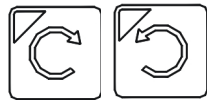

Spindle CW/CCW

The **SPINDLE CLOCKWISE/COUNTERCLOCKWISE** keys determine the direction the spindle will turn if it is started manually. If the spindle is started automatically, the direction keys are ignored and the spindle runs according to the program. The default direction is CW.



Spindle Speed +

Pressing this key will increase the spindle speed by 10% of the commanded speed in Auto spindle mode, limited by the maximum speed or 200% of commanded speed, whichever is less. For manual spindle mode, the spindle speed is increased by 5% of the maximum spindle speed (up to the maximum speed). The LED is on if the spindle speed is set above the 100% point.



Spindle Speed 100%

Pressing this key will set the spindle speed at the 100% point, which is defined as the commanded speed in Auto spindle mode, or 1/2 the maximum spindle speed in manual mode. The LED will be on when the spindle is at the 100% point.



Spindle Speed -

Pressing this key will decrease the spindle speed by 10% of the commanded speed in Auto spindle mode, limited to 10% of commanded speed. For manual spindle mode, the spindle speed is decreased by 5% of the maximum spindle speed down to 5% of maximum. The LED is on if the spindle speed is set below the 100% point.

Spindle (Auto/Man)

This key selects whether the spindle will operate under program control (automatic) or under operator control (manual). When the LED is lit, the spindle is under automatic control. If the LED is off, the spindle is under manual control. Pressing the **SPINDLE (AUTO/MAN)** key will toggle it from AUTO to MAN and back again. The default is AUTO mode.



Spin Start

Press the **SPIN START** key when manual spindle mode is selected to cause the spindle to start rotating. Press **SPIN START** when automatic mode is selected to restart the spindle if it has been paused with **SPIN STOP**.



Spin Stop

Press the **SPIN STOP** key when manual spindle mode is selected to stop the spindle. Press **SPIN STOP** when automatic mode is selected to pause spindle rotation and can be restarted with **SPIN START**.

NOTICE **SPIN STOP** should only be pressed during **FEED HOLD** or when a program is NOT running.

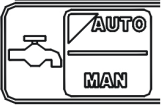

Coolant Auto/Manual

This key will toggle between automatic and manual control of coolant. In automatic mode, M7 (Mist) and M8 (Flood) can be used in G-code programs to select the coolant type to be enabled. In manual mode, flood coolant and mist coolant are controlled by separate keys. Note: When switching from automatic to manual mode, both flood and mist coolants are turned off automatically.



Coolant Flood

In manual coolant control mode, flood coolant can be toggled off and on by pressing this key. The LED will be on when flood control is selected in either automatic or manual mode.



Coolant Mist

In manual coolant control mode, mist coolant can be toggled off and on by pressing this key. The LED will be on when mist control is selected in either automatic or manual mode.

Auxiliary Function Keys (AUX1 – AUX12)

The M-Series jog panel has nine auxiliary keys, some of which may be defined by customized systems.

Notes about operator panels

The behavior of the control system in response to the functions listed above for the M-Series jog panel is dependent upon optional software options, the PLC program, machine parameters, and hardware wiring of the system. It is possible that the functioning explained in this chapter does not apply to a particular control system or that it may differ in some aspects.

Keyboard Jog Panel

The PC keyboard may be used as a jog panel. Press **Alt-J** to display and enable the keyboard jog panel. The jog panel appears as shown below:

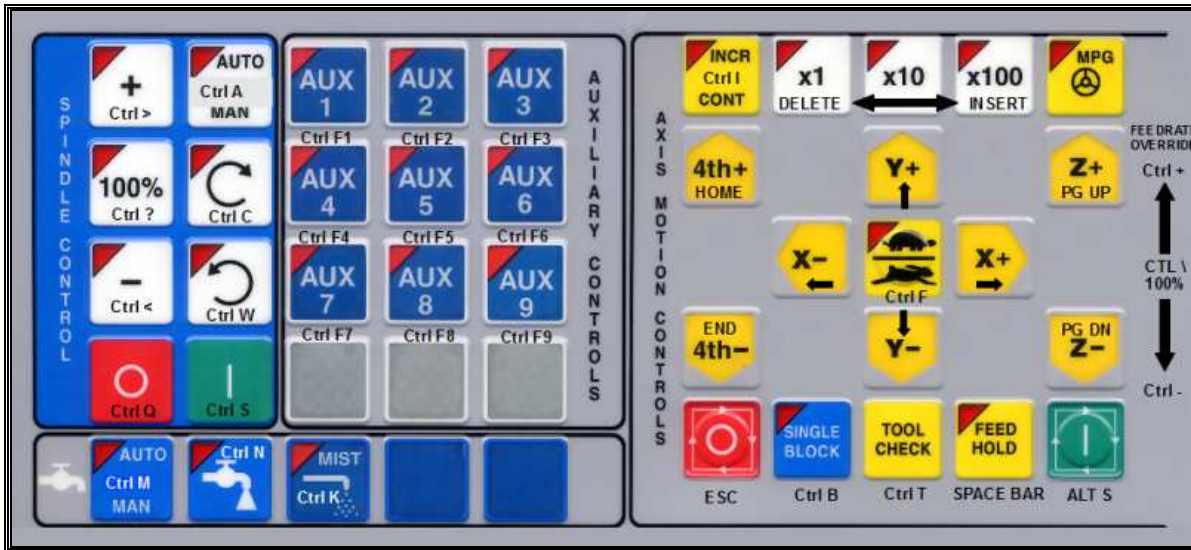















Some controls, such as coolant on/off, spindle on/off, feedrate and spindle override will work without the “jog panel” being displayed but for full functionality (and jogging) of the keyboard jog panel, the “jog panel” must be displayed on the screen. To enable keyboard jogging, parameter 170 must be set to “1”.





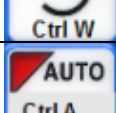

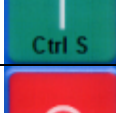
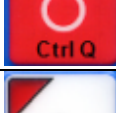
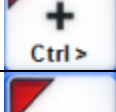

The status window in the upper right corner of the screen displays the jogging mode (continuous/incremental), incremental step size, and jog speed (fast/slow). In continuous mode, the jog keys start movement when pressed and movement stops when you release the key. In incremental mode, the axis will move the indicated incremental step amount.

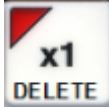
As shown in the picture above, the jog keys are located in the cursor key block to the right of the main keyboard and to the left of the numeric keypad. If a jog key controls an axis, it will be overlaid with the axis symbol (“X”, “Y”, etc.) The jog keys are the **arrow keys**, **Page Up**, and **Page Down**.

The remaining keys are described below:

Legend	Key(s)	Function	Description	Availability (Notes)
	Ctrl S	Cycle Start	Same as Cycle Start.	Always, with few exceptions.
	Esc	Cycle Cancel	Same as Cycle Cancel.	During a job run; otherwise, Esc is used to exit menus.
	Space	Feed Hold	Turns Feed Hold on and off	Always, with few exceptions.
	Alt J	Start/Exit Panel	Invokes or exits the jog panel.	Always, with few exceptions.
	Ctrl F1 - Ctrl F12	Aux 1 – Aux 12	Executes the corresponding Aux function and signals the PLC. A custom PLC program is required to act upon jog panel signals.	Always, with few exceptions.

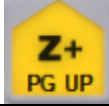
Legend	Key(s)	Function	Description	Availability (Notes)
	Ctrl M	Toggle Auto Coolant	Toggles coolant mode between auto and manual.	Always, with few exceptions.
	Ctrl N	Turns on/off Flood	Toggles Flood coolant if in manual mode	Always, with few exceptions.
	Ctrl K	Turns on/off Mist	Toggles Mist coolant if in manual mode	Always, with few exceptions.
Feedrate Override +	Ctrl +	Increase feedrate override	Increase feed rate override by 1% while held.	Jog panel, job run, graphing, and some other times
Feedrate Override -	Ctrl -	Decrease feedrate override	Decrease feed rate override by 1% while held.	Jog panel, job run, graphing, and some other times.
	Ctrl C	Selects CW Spin	Selects CW Spin dir in man mode	Always, with few exceptions.
	Ctrl W	Selects CW Spin	Selects CCW Spin dir in man mode	Always, with few exceptions.
	Ctrl A	Toggle Spindle Auto/Manual	Toggles between automatic and manual spindle operation.	Always, with few exceptions.
	Ctrl S	Spin Start	Starts spindle in selected direction if in manual mode	Always, with few exceptions.
	Ctrl Q	Spin Stop	STOPS spindle regardless of auto or manual mode.	Always, with few exceptions.
	Ctrl >	Spindle Override +1%	Increase the spindle override by 1% while held.	Always, with few exceptions.
	Ctrl <	Spindle Override -1%	Decrease the spindle override by 1% while held.	Always, with few exceptions.
	Ctrl T	Tool Check	Performs a tool check.	Always, with few exceptions.
	Ctrl I	Incremental/Continuous Jog Selection	Toggles incremental or continuous jog mode.	Available most times that jogging is available.
	Ctrl B	Selects Single Block Mode	Selects single block mode	Always, with few exceptions.

Legend	Key(s)	Function	Description	Availability (Notes)
	Delete	Decrease Jog increment	Decreases current jog increment to the next lower available increment	Always, with few exceptions.
	Insert	Increase Jog Increment	Increase current jog increment to the next higher available increment	Always, with few exceptions.
	Left arrow	X - Jog		With on screen jog panel displayed
	Right Arrow	X+ Jog		With on screen jog panel displayed
	Up Arrow	Y+ Jog		With on screen jog panel displayed
	Down Arrow	Y- Jog		With on screen jog panel displayed
	Page Up	Z + Jog		With on screen jog panel displayed
	Page Down	Z - Jog		With on screen jog panel displayed

MDI and the Keyboard Jog Panel

Many of the keys used by the keyboard jog panel are also possible commands to MDI. To use the keyboard jog panel functions in MDI, you must press **Alt J**. You may jog; use the handwheels, or any other jog panel function. Press **Alt J** or **Esc** to return to MDI.

Keyboard Shortcut Keys

A computer style keyboard is supplied with most systems. This keyboard can be used as a jog panel. The keyboard jog panel has many “hot keys”. Hot keys are keys that can be used at almost any time, with few exceptions. Some menus may prohibit their use. The CNC software has many other hot keys in addition to the jog panel hot keys. The hot keys are listed below.

Hot Keys

Hot Key	Action
Ctrl A	Spindle auto/manual
Ctrl N	Flood coolant on/off*
Ctrl M	Toggle Auto Man Coolant
ALT D	Switch between current position and machine position
CTRL D	Switch DRO between position and distance to go
CTRL K	Mist coolant on/off*
ALT F	Displays available system memory
ALT I	PLC diagnostics

Hot Key	Action
ALT J	Enables keyboard jogging*
ALT K	Displays current ATC tool bin location
ALT M	MDI
Ctrl T	Tool check*
ALT P	Live PID display
CTRL P	Clear max and min error display
Ctrl C	Spindle CW*
Ctrl W	Spindle CCW*
Ctrl S	Start Spindle*
Ctrl Q	Stop Spindle
ALT S	Cycle start
ALT T	Displays current motor temperature estimates
ALT V	Displays current software version #
ALT W	MPG on/off*
ALT + / ALT -	Selects next/previous WCS, cycles through WCS 1-18**
ALT 1 - ALT 0	Selects WCS 1 – WCS 10**
ALT Tab	Cycle through currently running applications
CTRL F1 - CTRL F12	Executes Aux function 1 – 12*
CTRL V	Enables/disables Stall detection in PID Configuration***
CTRL I	Creates plcstate.txt when PLC diagnostics is displayed***
CTRL E	Starts the PLC Debugger***

Notes: * This is a keyboard jog panel function.
 ** Not available during jobs or on jog panel.

Chapter 3

CNC Software Main Screen

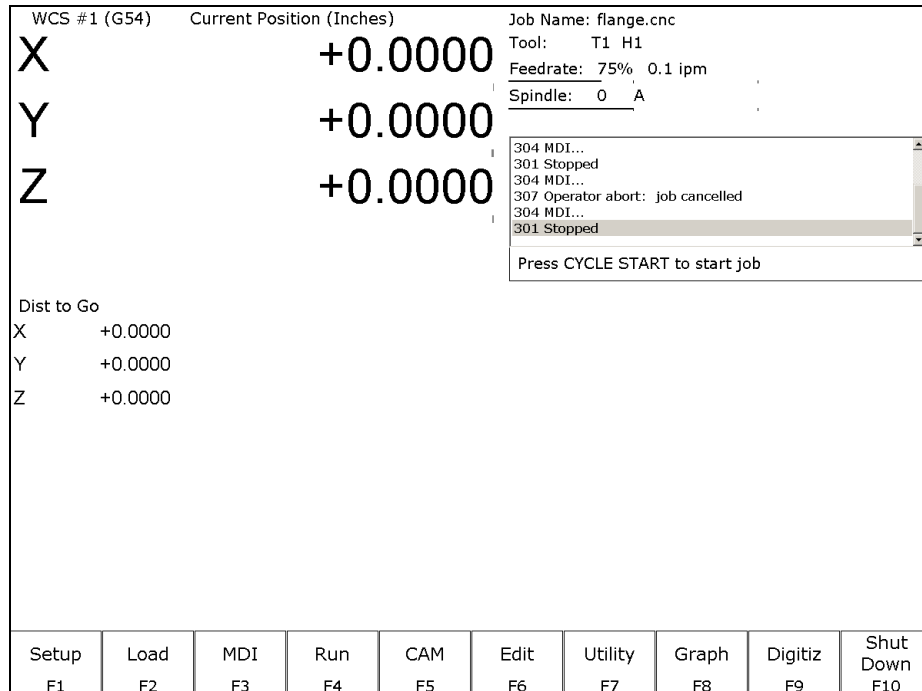

Menu Options:

- F1 – Setup** Used to set part zeroes, set or change tool offsets, and change the control configuration.
- F2 – Load** Use this menu to load a job
- F3 – MDI** The MDI menu allows you to a single line command such as: G1 X2 Y3 F20
- F4 – Run** Use the Run menu to search and run a job from a specific line, resume a job after it has been canceled or to change the way a job runs.
- F5 – CAM** Use the CAM menu to program parts.
- F6 – Edit** Brings up a G-code (text) editor that allows you to edit the currently loaded job.
- F7 – Utility** View available software options, backup part and configuration files, create new directories, and import/export files to and from external locations.
- F8 – Graph** Graphs the toolpath of the currently loaded part program.
- F9 – Digitize** Displayed only if the Digitizing option has been purchased. Used to Digitize (reverse engineer) parts.
- F10 – Shut down** Power off control. Shutting down your machine without using this menu may damage your control.

F1- Setup Menu

WCS #1 (G54)		Current Position (Inches)		Job Name: flange.cnc			
X Y Z	+0.0000		Tool: T1 H1		Feedrate: 75% 0.1 ipm		
	+0.0000		Spindle: 0 A		<div style="border: 1px solid black; padding: 2px;"> 304 MDI... 301 Stopped 304 MDI... 307 Operator abort: job cancelled 304 MDI... 301 Stopped Press CYCLE START to start job </div>		
	+0.0000						
Setup CNC11 Mill v3.____ URL: /cnc11/trunk May 00 0000, 00:00:00 SYSTEM ID 0000000000							
Part	Tool	Config	Feed	Z off	W off	ATC	Smoothing Setup
F1	F2	F3	F4	F5	F6	F7	F8

Setup Menu:

- F1 – Part** This key displays the Part Setup menus that are explained in Chapter 4.
- F2 – Tool** This key displays the Tool Setup menus that are explained in Chapter 5.
- F3 – Config** This key displays the Configuration menu that is explained in Chapter 14.
- F4 – Feed** This key displays the Feed menu that is discussed in Chapter 6.
- F5 – 3rd Axis Toggle** This key will only be displayed if machine parameter 130 is set. See Chapter 14 for configuration options.
- F6 – 4th Axis Toggle** This key will only be displayed if machine parameter 131 is set. See Chapter 14 for configuration options.
- F7 – ATC** This key will only be displayed if machine parameter 6 is set to 1.0. It has the same effect as the F7 - ATC key in the Tool menus. It will prompt you for a tool number and then perform the actions required for an automatic tool change cycle.
- F8 – Smoothing Setup** This gives you access to the Smoothing Setup Menu which provides a simplified way of choosing parameters for the Smoothing module. See Chapter 14 under “Smoothing Setup Menu”.

F2- Load Job Menu

Job Name: c:\cncm\ncfiles\bracket.cnc

Use arrow keys to select file to load and press F10 to Accept.

arcs.cnc
bracket.cnc
flange.cnc
test fixture plate.cnc

Job to load? bracket.cnc

G code /ICN F1	Floppy /USB/LAN F2	Details On/Off F3	Show Recent F4	Date/ Alpha F5	Edit F6	Help On/Off F7	Graph F8	Advanced F9	Accept F10
----------------------	--------------------------	-------------------------	----------------------	----------------------	------------	----------------------	-------------	----------------	---------------

- F1 – G code/ICN** Allows the user to change which types of files are displayed.
- F2 – Floppy/USB/LAN** Select a different drive from which to load files.
- F3 – Details** Displays file details including: Programmer, Description and Date Modified.
- F4 – Show Recent** Displays a list of the 15 most recently loaded jobs.
- F5 – Date/Alpha** Toggles the current view of files to be sorted alphabetically or by date modified.
- F6 – Edit** Opens selected file in editor.
- F7 - Help** Displays on screen help for the load screen.
- F8 - Graph** Backplots (graphs) the selected file.
- F9 - Advanced** Displays a unified file and device browser similar to Windows Explorer.
- Page Up** Move the cursor backward one page.
- Page Down** Move the cursor forward one page.
- END** Select the last file in the list.
- HOME** Select the first file in the list.

Arrow Keys

*Note: The path and/or file name may also be selected by typing the path or path and file name. A window will open automatically when you begin typing.

F3 –MDI

MDI mode allows you to directly enter M and G-codes one line at a time. After entering the M and G-codes you wish to run, press cycle start to have the controller execute the command. When the command has finished executing the command, it will prompt you for another line. When you are finished entering commands, press **ESC**.

Examples:

Block? G92X0Y0 ; Set the current XY position to 0,0
 Block? M92 /Z ; Move the Z to the positive limit.
 Block? M26 /Z ; Set the current Z position as Z home

F4 – Run Menu

Current Position (Inches)		Job Name : bracket.cnc	
X	+4.0000	Tool :	T001 H001
Y	+2.0000	Feedrate :	100%
Z	- 0.5000	Spindle :	0 M
		Stopped Waiting for PLC operation <hr/> Press CYCLE START to start job	
Run			
Single Block Mode:	Off	Run-Time Graphics:	Off
Optional Stops:	Off		
Block Skips:	On		
Job Repeat:	Off		
Search F2	Repeat On F3	/Skips Off F4	Block F5
		Stops F6	Graph F8
		Rapid Off F9	RTG On/Off F10

Run job options:

- F2 – Search** You can resume a job by searching for the line, tool, or a block number.
- F3 – Repeat** Toggles Job Repeat. Will repeat the current program when a job is finished.
- F4 – Block Skips** Turns on and off block skips in part programs.
- F5 – Single Block** Program runs in single block mode when turned on.
- F6 – Stops** Turns on and off optional stops (M01) in part programs.
- F8 – Graph** Graphs tool path of currently loaded program
- F9 – Rapid** Turns on and off rapid override function
- F10 – RTG** Turns on and off Run Time Graphics

*Note: For more information on these options, please see chapter 6.

F5 – CAM

X Y Z	Current Position (Inches)	+4.0000	Job Name : bracket.cnc
		+2.0000	Tool : T001 H001
		- 0.5000	Feedrate : 100%
			Spindle : 0 M
			Stopped Waiting for PLC operation
			Press CYCLE START to start job
CAM Selection			
		ICN	- Intercon Mill
		Engrave	- DXF Engraving
		Milwrt	- Millwrite Engraving
		Manual	- Operators Manual
ICN F1	Engrave F2	Milwrt F6	Manual F4

Choose **F5-CAM** to program parts. The default part programming system is Intercon. Intercon is a conversational programming system that allows you to quickly and easily create a part program. Intercon features many easy to use canned cycles for most common machining operations such as: rectangular, circular and irregular pockets, pockets with islands, bolt hole circles, frames, thread milling operations and much more. When you are finished programming your part in Intercon, exit to return to the M-Series Control Main Screen and the posted Intercon program will be automatically loaded and ready to run. For more information on Intercon, see chapter 10.

F1 – ICN Intercon conversational program system

F2 – Engrave DXF engrave option (optional item part of DXF Import) allows you to import an entire DXF drawing and engrave it onto a part.

F3 – Milwrite Millwrite Engraving software (optional item) allows you to create engraving files to engrave letters, numbers, and symbols on your parts.

F4 – Manual Allows you to access the operator manual on the control

F6 – Edit

This key causes the control to load the current job into a text editor for viewing and/or editing.

When editing, care must be taken to save the file and to quit and exit the text editor before running the file (the current job). Modifying a file that is currently running as the current job is dangerous and will cause unexpected results. It is best practice to not edit any files while the machine is moving.



WARNING Editing a file (modifying and saving) **while the machine is moving** can cause personal injury or machine damage.

Also, note that the C:\CNCM directory contains configuration files and binary data. DO NOT edit these files. Doing so can cause loss of data and serious malfunctions.



WARNING Do not edit configuration data located in the C:\CNCM directory. Doing so can cause personal injury or machine damage.

F7 – Utility

From the utility menu you can view available software options, perform diagnostics, backup part and configuration files, create new directories and import or export files to and from external locations. **For further information please see chapter 7.**

F2 – Restore Report	Update your control's configuration with a <i>report.zip</i> file.
F3 – Backup Files	Backup your CNC and ICN files
F4 – Restore Files	Restore your CNC and ICN files
F5 – File Ops	Use this menu to perform file and directory operations.
F6 – User Maint	Perform user maintenance.
F7 – Create Report	Generates a backup of system configuration files called <i>report.zip</i> .
F8 – Options	Shows the software options that you have purchased or added to your control.
F9 – Logs	Shows the messages and errors that have been logged by the control.

F8 – Graph

This function plots the tool path of the current program loaded. Canned drilling cycles are shown in gray. Rapid traverse movements are shown in red. Feedrate movements are shown in yellow and cutter compensated moves are in gray.

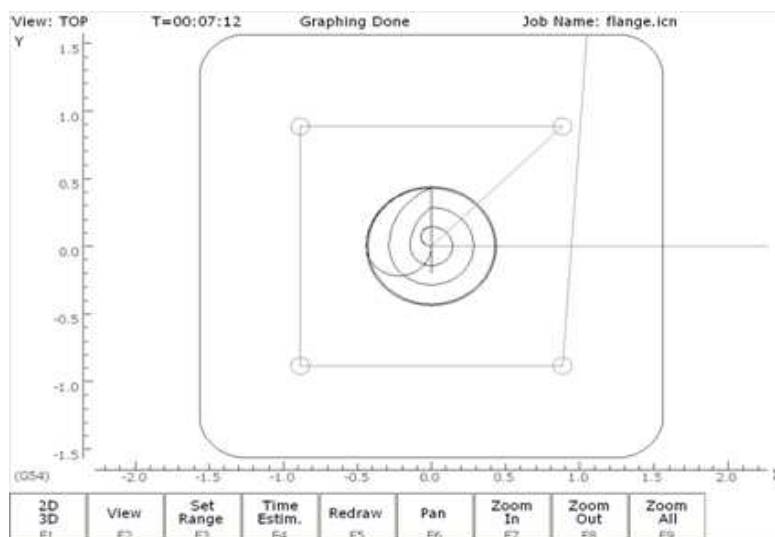

- F1 - 2D/3D** Press this key to view your part isometrically (3D). An axis pointer indicates the current direction of the view. To return back to the tri-planar view, press F1 again.
- F2 – View/Rotate** Press this key to change the planar view of your part. The view is indicated by TOP, RIGHT, or FRONT shown at the top of the screen. In 3D Mode, use this key in 3D mode to rotate your part, using the keyboard arrow keys to rotate any in direction.
- F3 – Range** Press this key to set the range of line numbers or block numbers to graph.
- F4 – Time** Press this key to estimate the time needed to create part. It takes into account accelerations and decelerations, but neglects tool change times.
- F5 – Redraw** Press this key to redraw the part at any time.
- F6 – Pan** Press this key to move the part around the screen. Once pressed, use the crosshairs to pick a location of the part that will redraw at the center of the screen. Once a section is selected, press F6 again to continue panning.
- F7 - Zoom In** Press these keys to zoom into the part relative to the center of the screen.
- F8 - Zoom Out** Press these keys to zoom away from the part relative to the center of the screen.
- F9 - Zoom All** Press this key to view the entire part fit inside the screen.

*Note: Use the FEEDRATE OVERRIDE knob to control the speed of the graphing. To pause the tool path, turn the knob counter-clockwise until it stops. Turn the knob clockwise to resume drawing. On the offline demo software, the simulated FEEDRATE OVERRIDE knob is controlled by pressing either Ctrl + or Ctrl –.

Accelerated Graphics Backplot

Accelerated Graphics Backplot is a new tool path graphics display that takes advantage of the latest video graphics technology. This option is enabled by setting Parameter 260 to 1 (See Chapter 14). Under Accelerated Graphics Backplot, the operation of the user interface is slightly different from the regular Graphing described above.

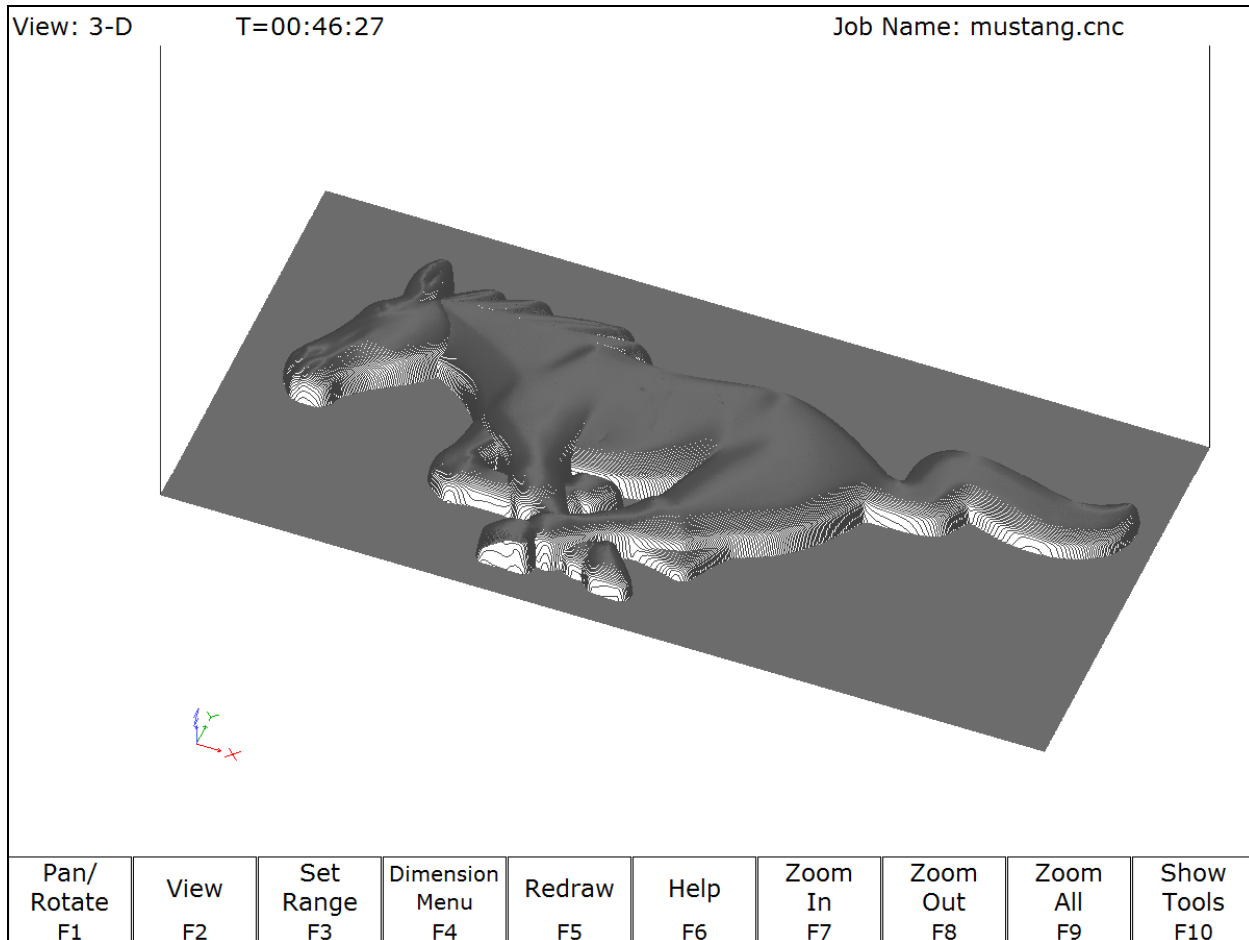

- F1 - Pan/Rotate** Press this key to change the behavior of the keyboard arrow keys. Normally, they will pan (scroll) around the drawing, but after pressing this key the arrow keys will control rotation instead. When in rotation mode, an axis indicator is drawn to mark the center of rotation.
- F2 - View** Press this key to change the planar view of your part. The view is indicated by TOP, RIGHT, or FRONT shown at the top of the screen.
- F3 - Set Range** Press this key to select which lines of G-code to display. Only lines that fall within the range you specify will be drawn.

F4 - Dimension Menu Press this key to access the following sub-menu of options:

F1 – Prev Line: Press this to walk forward to the next G-code line and graphically highlight it. If this G-code line contains movement, the Start and End points will be displayed at the bottom of the screen.

F2 – Next Line: Press this to walk backward to the previous G-code line and graphically highlight it. If this G-code line contains movement, the Start and End points will be displayed at the bottom of the screen.

F3 – Go To Line: Press this key to graphically highlight a particular G-code line whose line number you specify. If this G-code line contains movement, the Start and End points will be displayed.

F4 – Measure: Use this feature to measure between any 2 selected points. To do this, use a mouse to move the pointer over the first point and then press **F4 – Measure** to anchor the first point. Then use the mouse to move the pointer to the second point. As you move the mouse towards the second point, you will notice an Offset and Measurement display changing dynamically as you move the mouse. Also you may notice some “snap to” effects as you move the pointer close to start and end points of entities that make up your program.

F5 - Redraw Press this key to redraw the part slowly, which can be useful for visualizing the movements the machine will make. While the display is being redrawn, you can use the feedrate override knob to adjust the rate at which it is being drawn. If you don't have a feedrate override knob, the + and - keys can be used to adjust the rate. Pressing F5 again will cancel this mode.

F6 - Hide Rapids Press this key to hide rapid movements. Press it again to show them.

F7 - Zoom In Press these keys to zoom into the part relative to the center of the screen.

F8 - Zoom Out Press these keys to zoom away from the part relative to the center of the screen.

F9 - Zoom All Press this key to fit the entire part inside the screen.

F10 - Show Tools Press this key to show the tools menu, which allows you to highlight movements of certain tools. Press this key again to hide the tools menu.

Spacebar - Measure Press this key to take a measurement between two points. In a 2D view, this measurement will be a 2D measurement. In a 3D view, it will be a 3D measurement (and the measurement will only be valid if the crosshairs are snapped to a line of the tool path).

*Note: If you have a mouse or touch screen attached to your device, you can use that to control the graphing window. Holding the left mouse button allows you to drag the part across the screen, while the right mouse button controls rotation of the part. Spinning the mouse wheel (or holding both left and right buttons) zooms in and out. Double clicking on a feedrate movement will center the camera on that movement (which is very useful) and also tells you the length of that movement. For touchscreen operation, use the F1 key to switch between Pan and Rotate modes.

F9 – Digitize

Use this to bring up the Digitize screen. This screen allows you to set up and run touch probe digitizing. See Chapter 8 for a detailed description of the digitizing operation.

F10 – Shutdown

Use to enter the Shutdown menu. This menu allows you to park the machine, power off the control, start a command window or exit CNC software.

- F1 – Park** Use this to park the machine at the end of the day for quicker machine homing at startup. Once F10- Park is selected, The CYCLE START key must be press to start machine movement. The park feature homes each axis, at the maximum rate, to $\frac{1}{4}$ of a motor revolution from its home position.
- F2 – Poweroff** Use this to properly shutdown the control. With most controls, this action turns off the control once the system has prepared itself to be shutdown. Just like a desktop computer, the control should be properly shutdown before turning off the power in order to reduce the risk of corrupting data on the hard drive. This will only turn off the control. The machine itself will still need to be manually turned off.
- F6 – System Prompt** This brings up the command line interface. Type the command exit to exit the command window.
- F9 – Exit CNC11** Use this to exit the CNC control software.

Chapter 4

Part Setup

(F1 from Setup)

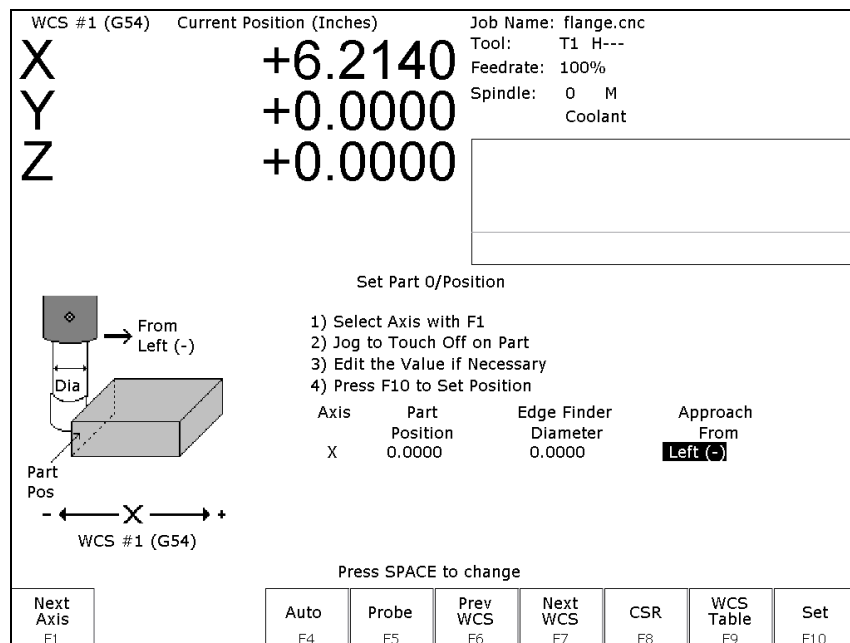

The Part Setup menu is used to set the part position or the coordinate system origin for the part.

F1 – Next Axis Will toggle to the next axis. If changes were made to the current axis, but not yet accepted, they will be discarded.

F4 – Auto Uses probe to automatically measure and set part position. Make sure your probe height and diameter offsets are set for the tool number you assigned to the probe and that parameter 12 is set to that tool number. See Chapter 9 for more details.

F5 – Probe Will open the probing operations menu. See Chapter 9 for details.

F6 – Prev WCS Will select the previous work coordinate. The position being set will only affect the currently selected work coordinate.

F7 – Next WCS: will select the next work coordinate. The position being set will only affect the currently selected work coordinate.

F8 – CSR Will open the CSR menu, which can be used to automatically detect coordinate system rotation. This function key appears only when the software option for Coordinate System Rotation is unlocked.

F9 – WCS Table Will open the Work Coordinate System (WCS) Configuration screen. See the Work Coordinate System Configuration section later in this chapter for a complete description.

F10 – Set Will accept the position for the current axis, correcting for edge finder diameter based on the approach direction if appropriate. It will not automatically advance to the next axis.

Operation Description

Setting the part position establishes a coordinate system with an origin at the part zero.

The **F1 - Next Axis** option selects the axis to be defined next. This field toggles between axis X, Y, Z, 4th, and 5th Axes. For each axis you will see a graphic description of the parameters to be entered, as well as the corresponding fields.

Setting up X or Y AXIS

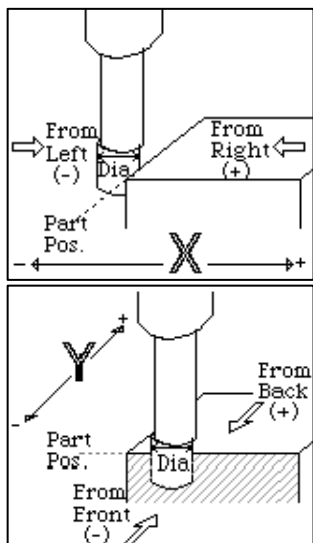

Set Part Position

- 1) Select Axis with F1
- 2) Jog to Touch Off on Part
- 3) Edit the Value if Necessary
- 4) Press F10 to Set Position

Axis	Part Position	Edge Finder Diameter	Approach from
X	0.0000	0.0000	Left (-)

Part Position: enter the value of your part zero position or the offset.

Edge Finder Diameter: enter the diameter of the tool, or edge finder you are using to determine the part zero. The value entered is stored.

Approach From: Toggle the direction the edge finder or probe is approaching the part.

*Note – Use the arrow keys to toggle between Part Position, Edge Finder Diameter, and Approach From options.

Setting up the Z AXIS

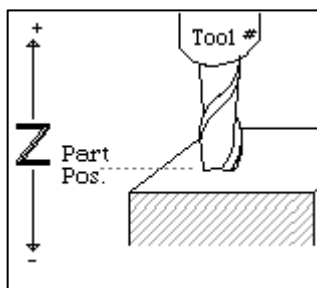

Set Part Position

- 1) Select Axis with F1
- 2) Jog to Touch Off on Part
- 3) Edit the Value if Necessary
- 4) Press F10 to Set Position

Axis	Part Position	Tool Number
Z	0.0000	0

Part Position: enter the value of your part zero position or the offset.

Tool Number: enter the tool number from the Tool Library that corresponds to the tool being used. When the Tool Number field is set to a value other than zero, the controller uses the Height Offset for that tool from the Tool Library to calculate the actual position.

Example 1 (You are using the reference tool to find the Z-axis part zero):

Set Tool Number to 0: setting the Tool Number to zero tells the controller that you are using the reference tool.

Example 2 (You are using a tool other than the reference tool, and not a ball nose cutter):

Set Tool Number to a number tool that is assigned in the tool library (make sure its height offset is set).

Example 3 (You are using a ball nose cutter, other than the reference tool):

Set Part Position to the position of the surface plus the nose radius of the ball nose cutter, set Tool Number to the number this tool is assigned in the tool library.

The Tool and Offset libraries must be up to date before setting the Z-axis Part Zero.

Setting up the 4th or 5th AXIS***

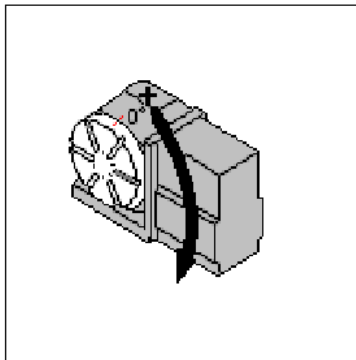

Set Part 0/Position

- 1) Select Axis with F1**
- 2) Jog to Touch Off on Part**
- 3) Edit the Value if Necessary**
- 4) Press F10 to Set Position**

Axis	Part Position	Standoff Distance	Approach from
B	0.0000	0.0000	+

Position: enter the value of your part zero position or the offset.

Standoff Distance: this field is a generic parameter. Its physical meaning will depend on the specific nature of your machine's fourth axis. It is the distance between the center of the tool and the point at which the tool is touching the part surface.

Approach from: enter the direction the edge finder is approaching the part from. Enter the correct direction given the nature of your 4th-Axis.

Using Multiple Work Coordinate Systems

If you will be using multiple work coordinates, you must set the part position separately for each work coordinate. Follow the instructions above to set the position for each axis in the first coordinate system. Then move to the next fixture and press **F6 – Prev WCS** to select the previous work coordinate or **F7 – Next WCS** to select the next work coordinate. The currently selected coordinate system is displayed below the axis picture on the Part Setup screen. It is also displayed above the DRO at all times. For a description on setting up each work coordinate, see the Work Coordinate System Configuration section later in this chapter.

NOTICE This procedure does NOT apply to tilt table setup.

Part Setup Examples

Example 1: Setting the X-axis Part Zero with no offset (See diagram below)

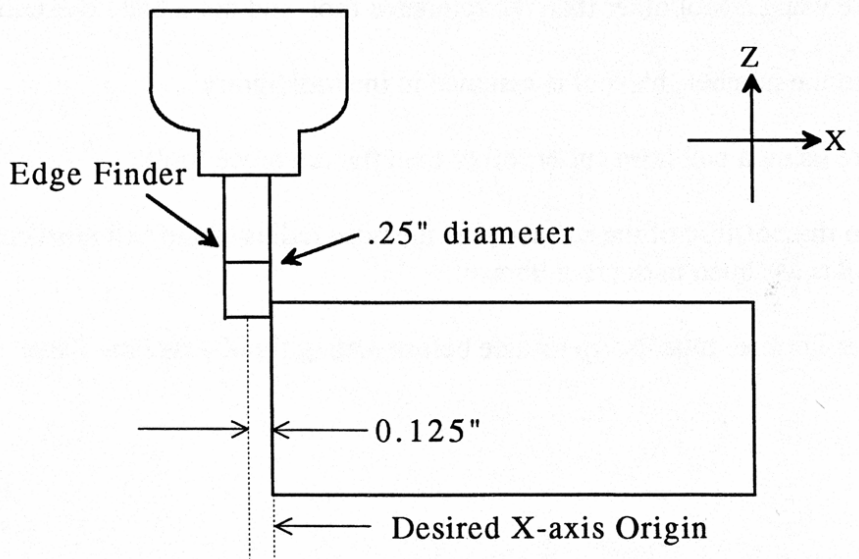

If you wanted the left edge of the part to be the origin for the X-axis:

1. Move the Edge Finder to the left edge of the part
2. Press **F1** – **Next Axis** until the Axis label displays 'X'
3. Move the cursor to the Edge Finder Diameter field
4. Type .25 and press **ENTER**
5. Press **SPACE** until Left (-) is displayed
6. Press **F10 - Set** to accept the values

Axis	Part Position	Edge Finder Diameter	Approach From
X	0	0.25	Left (-)

Since no offset is being applied, Position is zero. The Edge Finder is approaching the part from the -X direction and has a diameter of .25 inches. Once this data is entered and **F10 - Set** is pressed, the X-axis DRO display will read -0.125. This means the center of the Edge Finder is sitting to the left (minus) of the part by 0.125 inches (half of the Edge Finder Diameter).

This value is computed by: Position (Approach from) Edge Finder Diameter / 2.

Where (Approach from) is the sign of the approach direction. In other words, if the approach direction is minus, then the value is: Position - Edge Finder Diameter / 2 = 0.0 - .25 / 2 = -0.125

Example 2: X-Axis origin offset into part 1 inch.

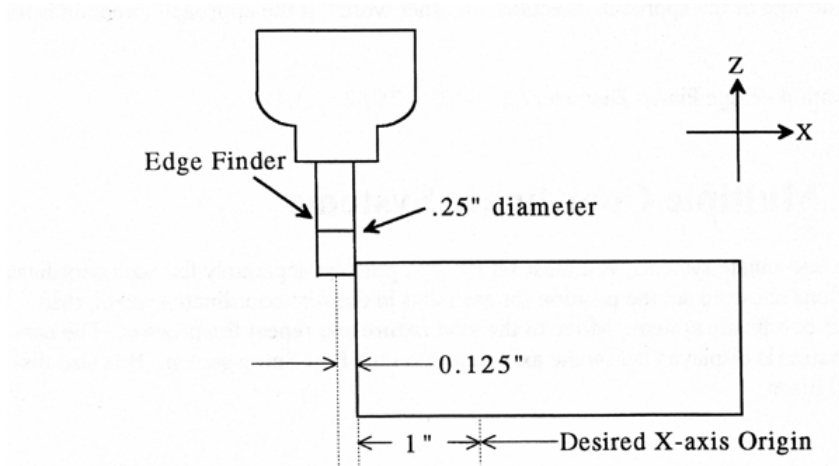

If you wanted the origin offset 1 inch into the part:

1. Move the Edge Finder to the left edge of the part
2. Press **F1 – Next Axis** until the axis field displays 'X'
3. Move the cursor to the Part Position field
4. Type -1 and press **ENTER**
5. Type .25 and press **ENTER**
6. Press **SPACE** until Left (-) is displayed
7. Press **F10 - Set** to accept the value

Axis	Part Position	Edge Finder Diameter	Approach from
X	-1	0.25	Left (-)

The Position value is relative to the current position of the Edge Finder. Part position equals -1.0 since the Edge Finder is positioned 1 inch to the left (minus direction) of where you want the X-axis origin.

Another way to view the Part Position value is to assume the origin is already set at 1 inch into the part. In this case, the Edge Finder would have to move -1 inches from where the origin is to get to the left edge of the part.

The Edge Finder is approaching the part from the -X direction and has a diameter of .25 inches. Once this data is entered and **F10 - Set** is pressed, the X-axis DRO display will read -1.125. This means the center of the Edge Finder is sitting to the left (minus) of the origin by 1.125 inches. The X-axis origin is now 1 inch into the part.

This value is computed by: Position (Approach from) Edge Finder Diameter / 2.

Where (Approach from) is the sign of the approach direction. In other words, if the approach direction is minus, then the value is:

$$\text{Position} - \text{Edge Finder Diameter} / 2 = -1.0 - .25 / 2 = -1.125$$

Work Coordinate Systems (WCS) Configuration

Press **F9 – WCS Table** from the Part Setup screen to display the Work Coordinates System (WCS) menu. The Work Coordinate Systems screen provides access to reference return points, coordinate system origins, and work envelope. Make sure your Home position has been set properly. Otherwise, the positions of each coordinate system will not be in the appropriate position.

When you enter the Work Coordinate System Configuration screen, the DRO display will automatically switch over to machine coordinates as an aid to entering numbers. All the values on this screen are represented in machine coordinates.

F1 - Reference Return Points Press this key access the menu that sets the reference return points for the machine.

Axis	Return #1 (G28)	Return #2 (G30)	Return #3 (G30 P3)	Return #4 (G30 P4)
X	0.0000	0.0000	0.0000	0.2757
Y	0.0000	0.0000	0.0000	-11.0000
Z	-0.5186	-0.5186	-0.5186	-0.5186
A	0.0000	0.0000	0.0000	23.7998
B	-60.8735	-60.8735	-60.8735	-60.8735
N	0.0000	0.0000	0.0000	0.0000
N	0.0000	0.0000	0.0000	0.0000
N	0.0000	0.0000	0.0000	0.0000

The reference return points are used with the G28 and G30 codes (see Chapter 12). They are specified in machine coordinates. The Z coordinate of the first reference point is also used as a Z home position by the M2, M6, and M25 codes (see Chapter 13).

F2 – Origin Use this key to access the menu for specifying the locations (in machine coordinates) of the origins for all 18 work coordinate systems. Pressing **F1 – Next Table** will allow you to view the other WCS (6 per page). This menu is a convenience and is not an absolute necessity for setting work coordinate system origins nor the CSR angles.

Axis	WCS #1 (G54)	WCS #2 (G55)	WCS #3 (G56)	WCS #4 (G57)	WCS #5 (G58)	WCS #6 (G59)
X	0.00000	38.13724	4.39686	0.00000	0.00000	0.00000
Y	0.00000	-16.33026	-13.80487	0.00000	0.00000	0.00000
Z	-10.00002	-26.98955	-21.76537	0.00000	0.00000	0.00000
A	0.00000	23.80869	23.80869	23.80869	23.80869	23.80869
B	0.00000	-60.87353	-60.87353	-60.87353	-60.87353	-60.87353
N	0.00000	0.00000	0.00000	0.00000	0.00000	0.00000
N	0.00000	0.00000	0.00000	0.00000	0.00000	0.00000
N	0.00000	0.00000	0.00000	0.00000	0.00000	0.00000
(optional) { CSR	-0.12340000°	0.00000000°	0.00000000°	0.00000000°	0.00000000°	0.00000000°
TWCS	Yes	No	No	No	No	No

All coordinate systems are relative to Home position that is set during control power up. Note that while in this screen, the DRO shows the actual machine position relative to Home, not the location relative to the WCS origin.

If the software option Coordinate System Rotation is unlocked, the CSR angle for each of the coordinate systems can also be set. (This is an optional feature.)

For machines configured as an Articulated Head system with the TWCS feature enabled (set via Paramter 166), the TWCS=Yes/No differentiates which WCS's are transformed or not. See Transformed WCS later in this chapter.

F3 – Work Envelope Use the **F3 – Work Envel** key to specify the ‘+’ and ‘-‘work envelope locations (in machine coordinates) used in conjunction with the G22 G code. The X, Y, Z and I, J, K parameters specified in the G22 G code are stored here, so subsequent G22 codes do not need to specify the limits unless they change.

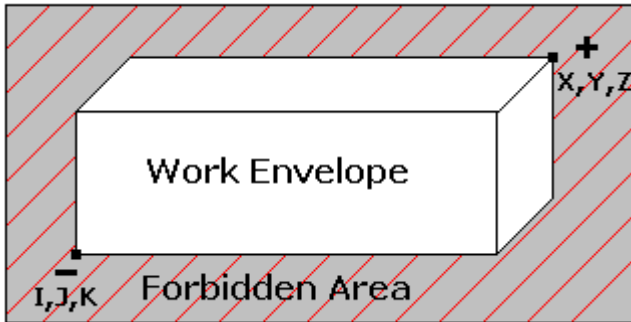

Note: The work envelope will only work in programmed moves. You will still be able to jog outside the work envelope.

Coordinate System Rotation (CSR)

Coordinate System Rotation saves you time when setting up your part. Rather than clamping your part and indicating the edge of the material to square it with the machine axes, you can use CSR to automatically rotate the coordinate system to the angle of the part or fixture that was probed. This allows you to compensate for different orientations.

Simply clamp your part, and then probe two points along either the X or Y-axis of the material using the process described below.

WCS #1 (G54)
Current Position (Inches)
Job Name: 2axtst05.cnc

X
Y
Z

+4.0018
+0.0008
-1.6385

Tool: T3 H--
Feedrate: 100%
Spindle: 0 A

304 MDI...
301 Stopped
304 MDI...
307 Operator abort: job cancelled
304 MDI...
301 Stopped

Coordinate System Rotation

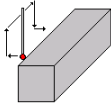

WCS #1 (G54)

1. Select orientation with F1
2. Position probe at one end of vise jaw
3. Enter distance to other end of jaw
4. Enter Z clearance amount (incr. from start)
5. Select automatic or manual move to other end
6. Press CYCLE START to start

Distance: 1.0000
Clearance Amount: 0.5000
Movement Between Points: Auto

Orient	Manual	Zero Cur	Zero All	Probe	Prev WCS	Next WCS	MDI	WCS Table
F1	F2	F3	F4	F5	F6	F7	F8	F9

- F1 - Orient** is used to select the orientation for the CSR measurement. There are four possible orientations, which are: from the front (pictured above), the back, and the left and right sides.
- F2 - Manual** is used to determine the CSR angle without probing. The user jogs an edge finder to two positions along one wall. These positions will be used for computing the CSR angle.
- F3 - Zero Cur** is used to set the CSR angle for the current WCS to zero.
- F4 - Zero All** is used to set all CSR angles to zero.
- F5 - Probe** Will open the probing operations menu. See Chapter 9 for details.
- F6 - Prev WCS** and **F7 - Next WCS** are used to cycle through the available WCS systems.
- F8 - MDI** The MDI menu allows you to a single line command such as: G1 X2 Y3 F20
- F9 - WCS Table** is a shortcut to the Work Coordinate System Configuration Screen described above.

The instructions on how to perform a CSR measurement are numbered on the screen.

Distance: The distance the X-axis (in front or back orientation) or Y-axis (in right or left side orientation) will move to probe the second point. If the distance is negative, the axis will be moved in the negative direction.

Clearance Amount: The distance the Z-axis will be moved upward when moving between the first probe point and the second probe point. The clearance move will only be made when using the “Auto” option of the Movement between Points.

Movement between Points can be toggled between Jog and Auto modes. In Auto mode, the clearing moves are made automatically as well as the move to the second point. In Jog mode, a prompt will be displayed in the center of the screen after the first point is probed.

Transformed WCS (TWCS=Yes)

This section only applies to Articulated Head machines with the TWCS feature enabled via Parameter 166 (see Chapter 14 for more information on setting Parameter 166). On such a machine, when a WCS has a setting of TWCS=Yes, this is then called a transformed WCS (abbreviated as TWCS).

When a TWCS is selected, the DRO will show axis positions based on the TWCS’s frame of reference. In other words, the shown positions are transformed based on the position of the B axis (5th axis). Furthermore, the WCS label will be shown as “TWCS” to indicate that the currently selected WCS is indeed transformed.

TWCS #1 (G54)	Current Position (Inches)	Job Name: bptest.cnc	Program #0
X	+0.0000	Tool: T10 H---	Part Cnt: 0
		Feedrate: 100% 0.0 ipm	

Also, when the Probing Cycles are run with a TWCS selected, the results shown will be based on the TWCS frame of reference.

Ordinary 3 axis moves types performed while running a CNC program with a TWCS selected will be automatically transformed. Such move types include:

- G0, G1, G2, G3
- Protected move probing functions M115, M116, M125, M126
- Canned Cycles G73, G74, G76, G81, G82, G83, G84, G85, G89
- M25
- Moves that involve CSR and Cutter Compensation

However, moves that will **not** be transformed are:

- Homing moves M91/M92
- Move to switch M105/M106
- Move axis by counts M128

Chapter 5

Tool Setup

(from Main Screen: F1 Setup ► F2 Tool)

Tool Setup allows you to specify information about the tools you will be using.
 Press **F1 - Offset Library**, to edit the Height Offset and Diameter (H and D) values, or
 Press **F2 - Tool Library** to edit the tool descriptions., or
 Press **F3 - Tool Life** to edit the Tool Life Management settings.

Offset Library

(from Main Screen: F1 Setup ► F2 Tool ► F1 Offset Lib)

The Offset Library file contains the values for the Height Offset and Diameter Numbers. For example, if entry H01 has a value of -.25, a height offset of -.25 is applied when height offset 01 is referenced. If entry D01 shows a value of 1.5, the diameter offset 01 has a diameter of 1.5 associated with it.

WCS #1 (G54) Current Position (Inches) Job Name: flange.cnc
 X +6.2140 Tool: T1 H--
 Y +0.0000 Feedrate: 100% Part Cnt: 10
 Z +0.0000 Spindle: 0 M Part #: 0
 Coolant

Tool #	Ref Tool	Height Offset	Diameter
H001		-1.1234	D001 0.1250
H002		-1.3562	D002 0.2500
H003		0.0000	D003 0.5000
H004		0.1324	D004 0.3750
H005		-3.1749	D005 0.6750
H006		0.0000	D006 0.0000
H007		0.0000	D007 0.0000
H008		0.0000	D008 0.0000
H009		0.0000	D009 0.0000
H010		0.0000	D010 0.0000

Diagram illustrating Height Offset and Diameter Offset. The diagram shows a tool with a diameter 'Dia' and a height offset 'Height Offset' relative to a 'Ref Pos' (Z Ref: 0.0000).

Z Ref	Manual Measure	Auto Measure	Batch	+.001	-.001	ATC	Save
F1	F2	F3	F4	F5	F6	F7	F10

Press **F1 - Z Ref** to set the Z reference height. Press **F2 - Manual** to manually measure tools. If you purchased the Automatic Tool Measurement (TT1) option, press **F3 - Auto** to automatically measure tool lengths. Press **F5 - +.001** or **F6 - -.001** to adjust the selected offset. If you have an automatic tool changer installed, press **F7 - ATC** to change tools. Press **F10 - Save** to save changes and exit, or **ESC** to exit without saving changes. If you have both purchased the Automatic Tool Measurement (TT1) option and also have an automatic tool changer installed, then you can press **F4 - Auto** to perform batch tool measuring, by entering a list of multiple tool numbers.

You can inspect and change any of the 200 Height Offset (H) values, and any of the 200 Diameter (D) values. In most cases you will use the automatic tool length measurement features described below to set H values, and you will enter D values manually, based on the known or measured diameters of your tools. Note that H01 and D01, H02 and D02, H03 and D03, etc. are displayed together on the same line for convenience only. The Height and Diameter Offset Numbers can be used independently; associations are made only in the Tool Library.

Height Offset

This is the distance the control adjusts Z-axis positions when tool length compensation (G43 or G44) is used with a particular H value. For example, if H001 is -1.0 and the job contains G43 H1, then the CNC software will shift all Z-axis positions down 1.0 to compensate for the shorter tool.

To edit the Height Offset entries move to the desired height offset number with the arrow keys, **Page Up**, **Page Down**, **HOME**, and **END**. You can choose to manually edit or automatically measure the value.

Height Offsets values are measured using the Z Reference position. The Z Reference position is the Z-axis position when the tip of the reference tool is touching the work surface. The reference tool should always be the longest tool.

The Height Offset value for end mills and drills is the difference between the Z-axis position when the tip of the tool is touching the work surface and the Z Reference position. The Height offset value for ball nose and bull nose cutters is the difference between the Z-axis position when the center of the tool is at the work surface and the Z reference position. Because it is not possible to position the tool in this way, you must instead move the tip of the tool to the work surface, and then manually edit the value to subtract the tool nose radius.

To manually edit a Height Offset value, simply type the desired value and press **ENTER**.

To manually measure Height Offset values, use the following procedure:

Establishing the Z reference position

Press **F1 – Z Ref** to select the Z Reference setting function.

Insert the longest tool into the tool holder (you can use the jog keys or the TOOL CHECK key to assist you).

Jog the tip of the tool down to the top of the work surface.

Press **F10 - Save** to save this Z Position as the Reference Position.

Measuring each tool height (Z position for tool minus Z position for Reference tool)

Insert the desired tool into the tool holder (Jog keys or the TOOL CHECK key can be used to assist you).

Jog the tip of the tool down to the top of the work surface.

If the tool is a drill or end mill, press **F2 –Manual Measure** to measure the height.

If the tool is a ball nose or bull nose cutter, press **F2 – Manual Measure** to measure the height, and then subtract the tool nose radius.

After a tool height is measured, the next Height Offset entry is automatically selected.

When the edit is complete, press **F10 - Save** to save the Offset Library and Exit.

Examples (assuming Z Reference = -1.5):

If the tool position is -1.75, then the tool height = -0.25

If the tool position is -1.75 and nose radius is .25, then the tool height = -0.50

If the tool position is -2.25, then the tool height = -0.75

If the tool position is -2.75 and nose radius is .125, then the tool height = -1.375

Diameter

This field tells the control the distance to adjust when cutter diameter compensation (G41 or G42) is used with a particular D value. For example, if D001 is 0.5 and the job contains G41 D1, the CNC software will adjust all X-Y positions 0.25 (half the tool diameter) to the left of the programmed tool path.

To edit the Diameter entries move to the desired diameter offset number with the arrow keys, **Page Up**, **Page Down**, **HOME**, and **END**. You must manually edit the Diameter Offset value. Type the desired value and then press the **ENTER** key.

You can make small adjustments to Height Offsets and Diameters using **F5 - +.001** and **F6 - -.001**. Use the arrow keys to highlight the value to be adjusted. Press **F5 - +.001** to increase the offset value by 0.001" (or 0.02 mm in Metric mode). Press **F6 - -.001** to decrease the offset by the same amount. If the cut parts are undersized, use **F5 - +.001** to cut less material. If the cut parts are oversized, use **F6 - -.001** to cut more material.

Automatic Tool Measurement

Z-minus single-surface probing, using the TT-1 tool touch-off post, is available in the Tool Offset Library.

First Time Setup

Make sure the proper parameters are set as per Chapter 9 and Chapter 14, and the detector is plugged in and is at the correct location on the table! When first testing the TT-1, hold the TT-1 in hand and manually touch the unit to the tool to confirm correct electrical connection and parameter setup.



WARNING

Incorrect setup may cause damage to the machine, tool and/or cause injury to the operator.

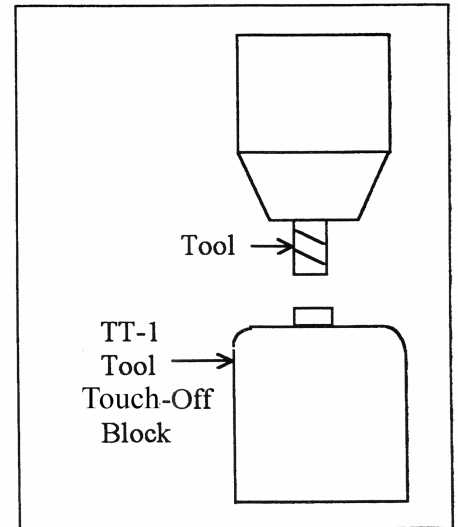

Setting the Z Reference:

Using the longest tool for the job to be run or the designated reference tool, press **F1 - Z Ref**, then **F3** and then **CYCLE START**. The Z-axis will then move down until the tool touch-off is detected. The Z reference will be set at that position. Parameter 3 bit 1 is used to set Z reference to Z home position. See the parameter section in Chapter 14 for more info.

Setting the Tool Height Offsets:

Pressing **F3 – Auto Measure** and then **CYCLE START** at the prompt will cause the Z-axis to move down until the tool touch-off is detected; the resulting tool length will be entered in the table (same as with **F2 - Manual**). The Z-axis then returns to its home position.

If Parameter 17 has been set to the number of a valid return point (1 or 2), the **F3 – Auto Measure** option will move the X and Y axes to that return point before moving Z down. Return point 1 is the G28 position from the Work Coordinate System Configuration screen (see Chapter 4). Return point 2 is the G30 position on that screen. If Parameter 17 is zero (0), the X and Y-axes will not move before Z moves down. In this case you must be careful to jog the machine directly over the detector before pressing **F3 – Auto Measure**.

Note: **SHIFT+F3** can be used to override any return point movement in cases where parameter 17 is set to use it. This is helpful for measuring tools wherein the height measurement is not taken from the center point of the tool.

Batch Tool Height Offset Measurement Process:

If you have both purchased the Automatic Tool Measurement (TT1) option and also have an automatic tool changer installed, then you can press **F4 - Batch** to measure multiple tools in one process. After pressing **F4 - Batch**, you will be prompted with the following dialogue box:

Enter the list of tools to measure.
Example: 1-4, 6, 15
---> █

After entering a list of tool numbers, you can press **CYCLE START** to perform the batch tool measurement process. This process is similar to the single tool height offset measurement (accessed via **F3 – Auto Measure**) but will do multiple tools in one shot.

Setting up Tool Height Offsets

NOTICE Before manually jogging any probe to a position, make sure the machine Feedrate is turned down (less than 10 in/min) or damage to the probe may result!!!

Using a Probe as the Reference Tool

Before you set the Z Reference, make sure the probe Tool # is entered into Parameter 12 on the Machine Parameters screen. Make sure that Parameter 17 on the Machine Parameters screen contains a 0. Follow these steps to probe Z Reference:

1. Load the probe into the machine.
2. Jog the probe over the desired reference surface and press **F1 – Z Ref**.
3. Press **F3** and then **CYCLE START**; the probe will find the Z Reference.

At this point, the Z Reference is now entered into the Offset Library and is the reference height for all other tools. Remove the probe and measure any other tool offsets manually as described earlier in this chapter.

Measuring Each Tool Offset Using a Fixed Detector

Before measuring any tool height, make sure you enter the probe or reference tool-measuring location. Do this by entering a reference point number (1 or 2) into Parameter 17 and entering the detector position as the corresponding Reference Return Point on the WCS Configuration screen. Otherwise, the machine may traverse to a location that could damage the probe or reference tool. Also remember that if Parameter 17 is zero (0), the X and Y-axes will not move before Z moves down. Also be sure that parameter 44 is set correctly. This is the input number for the TT1. Now that a permanent location has been set, do the following:

Load reference tool (preferably the longest tool) and highlight its corresponding Height Offset # using the up or down arrow keys.

Press **F1 – Z Ref**, then **F3 – Auto Measure** and then **CYCLE START** to set the Z reference using this tool. The X and Y-axes will traverse to the preset location, and then Z will move down until the tool is detected and the Z reference will be set.

Load the next tool.

Highlight the desired Height Offset # on screen using the up or down arrow keys.

Press **F3 – Auto Measure** and then **CYCLE START**. The X and Y-axes will traverse to the preset location, and then Z will move down until the tool is detected. Once the detector is triggered, the tool offset will show on the screen. A negative offset means the tool is shorter than the reference tool.

Once all of the tool offsets have been measured, press **F10 - Save** to save them. Otherwise, press **ESC** to cancel any changes.

Tool Library

(from Main Screen: F1 Setup ► F2 Tool ► F1 Tool Lib)

WCS #1 (G54)	Current Position (Inches)	Job Name : bracket.cnc						
X	+4.0000	Tool : T001 H001						
Y	+2.0000	Feedrate : 100%						
Z	-0.5000	Spindle : 0 M						
		Stopped Waiting for PLC operation						
		Press CYCLE START to start job						
Tool Library								
Tool	Bin	Ht.	Dia.	Coolant	Spindle	Speed	Description	
T001	000	H001	D0001	FLOOD	CW	500		
T002	000	H001	D0001	FLOOD	CW	500		
T003	000	H001	D0001	FLOOD	CW	500		
T004	000	H001	D0001	FLOOD	CW	500		
T005	000	H001	D0001	FLOOD	CW	500		
T007	000	H001	D0001	FLOOD	CW	500		
T008	000	H001	D0001	FLOOD	CW	500		
T009	000	H001	D0001	FLOOD	CW	500		
T010	000	H001	D0001	FLOOD	CW	500		
Clear Bin F1		Clear All F2						Save F10

The definitions in the Tool Library associate tool (T) numbers with height offset (H) and diameter (D) numbers, the default coolant type, spindle direction, and spindle speed for the tool, and a text description of the tool. This information is used by the Intercon-programming package (described in Chapter 10) to provide defaults whenever a tool change is selected. For enhanced ATC features, the (T) numbers are also associated with bin numbers. See Chapter 14 for more information about enhanced ATC features (parameter 160).

Note: If enhanced ATC features are not on, the cursor cannot be moved into the bin column and the message “Bin fields are locked.” will appear where the tool in spindle display is located. In addition, the **F1 – Clear Bin** and **F2 – Clear All** keys only appear if enhanced ATC features are on.

You can inspect and change any of the 200 tool definitions. To edit a Tool Library definition move to the desired tool number with the arrow keys, **Page Up**, **Page Down**, **HOME**, and **END**. To change Height Offset numbers, Diameter numbers, default spindle speed values and the tool description, type a new value into the field and then press **ENTER**. To change the default spindle direction and coolant press **SPACE** to cycle through the possible values. When the changes are complete press **F10 - Save** to save the Tool Library and exit.

Bin

This field specifies which bin location, or ATC carousel position, that the tool is occupying. Valid values are -1 (shown as dashes “---”) through the maximum number of tools specified by machine parameter 161. A value of 0 indicates that the tool is in the spindle. The **F1-F2** keys will work when the cursor is in the Bin column.

F1 - Clear Bin – places dashes “---” into the bin field (same as entering -1).

F2 - Clear All – places dashes into every bin field.

Note: For enhanced ATC applications, the bin numbers will be updated when tool changes are completed. For random, or arm type tool changers, tools in the spindle are placed into the bin where the next tool is picked up, and not necessarily from the bin which it was originally taken.

Height

This field specifies a default Height Offset (H) number to use with each tool. Possible values are 1 to 200. Intercon uses this information to provide a default H value at each tool change. The CNC software also uses this information to correct for the length of the tool that is used to establish the Z-axis position in Part Setup (see Chapter 5).

Diameter

This field specifies a default Diameter (D) number to use with each tool. Possible values are 1 to 200. Intercon uses this information to provide a default D value at each tool change. To change the value type a new number and press **ENTER**.

Coolant

This field specifies a default coolant type to use with each tool. Possible values are FLOOD, MIST, or OFF. Intercon uses this information to automatically insert M7 or M8 after a tool change. To change the value, press **SPACE** until the desired value is shown.

Spindle

This field specifies a default spindle direction to use with each tool. Possible values are CW, CCW, or OFF. Intercon uses this information to automatically insert M3 or M4 after a tool change. To change the value, press **SPACE** until the desired value is shown.

Speed

This field specifies a default spindle speed to use with each tool. Possible values are 0 to 500000. Intercon uses this information to automatically insert an S code after a tool change. To change the value, type a new number and press **ENTER**.

Description

This field contains a text description of the tool. The description will appear in a prompt message on the screen when the CNC software reaches a tool change (M6).

Tool Life Management menu

(from Main Screen: F1 Setup ► F2 Tool ► F1 Tool Life)

The Tool Life Management feature allows you to set up each tool’s pre-determined life, and have its usage tracked and monitored for end-of-life condition. By default, Tool Life Management is turned off, but can be enabled for each tool individually.

WCS #1 (G54) Current Position (Inches) Job Name: tlife-icn-test.cnc

X Tool: T21 H---

Y Feedrate: 100% 0.0 ipm Part Cnt: 0

Z Spindle: 0 A Part #↑: 8

335 Emergency stop released

Press CYCLE START to start job

Tool Life Management

Tool#	Type	Total Life	Used	Remaining	Units	Mode	Description
1	Drill	2500	1234.0	1266.0 (51%)	Inches	Auto	3/8" drill
2	Drill	500	100.0	400.0 (80%)	Inches	Auto	1/4" drill
3	Drill	1500	0.0	1500.0 (100%)	Cycles	Auto	1/8" drill
* 4	EM	2500	2500.0	0.0 (0%)	Inches	Auto	3/8" end mill
5	EM	500	78.0	422.0 (84%)	Inches	Auto	1/4" end mill
6	EM	1500	890.0	610.0 (41%)	Cycles	Auto	1/2" end mill
7	Drill	Off	0.0	0.0 (0%)	Inches	Manual	.
8	Drill	Off	0.0	0.0 (0%)	Inches	Manual	.
9	Drill	Off	0.0	0.0 (0%)	Inches	Manual	.
10	Drill	Off	0.0	0.0 (0%)	Inches	Manual	.
11	Drill	Off	0.0	0.0 (0%)	Inches	Manual	.
12	Drill	Off	0.0	0.0 (0%)	Inches	Manual	.

* Tool Life expired

Hide Unmanaged
F1

Sort Recent
F2

Sort Tool#
F3

Sort Remaining
F4

Save
F10

F1 – Show/Hide Unmanaged. This key toggles between including and excluding those tools that are unmanaged by Tool Life Management. A tool is unmanaged if its Total Life field is set to value 0 (Off).

F2 – Sort Recent. This key sorts the list according to the tools whose Total Life and/or Used field were most recently modified by tool usage in a job run or by edits done in this menu.

F3 – Sort Tool #. This key sorts the list ordered by Tool Number.

F4 – Sort Remaining. This key sorts the list ordered by the Life Remaining.

F10 – Save. Saves changes.

A tool can be set up for automatic management by setting its Mode to Auto and setting its Total Life to a non-zero value. The following table shows the effects of monitored tool activity on tools that are set up for automatic management.

Automatic Management: Mode = Auto and Total Life is more than 0			
Type	Units	Tool Activity that is monitored	Effect on the ‘Used’ field
Drill	Cycles	downward Z plunge at feedrate at a unique XY location	‘Used’ field will be incremented by 1 Cycle
Drill	Inch/mm	downward Z plunge at feedrate at a unique XY location	Total downward Z distances minus the overlaps will be added to the ‘Used’ field
EM (End Mill)	Cycles	Tool Change	‘Used’ field will be incremented by 1 Cycle
EM (End Mill)	Inch/mm	sideways XY feedrate moves (non-rapid)	XY distance will be accumulated in the ‘Used’ field

Detailed description of each field is as follows.

Type

This is the type of tool – either Drill or EM (end mill). When the Mode field is set to Auto, this field determines the type of tool activity that will be automatically tracked and monitored for the purpose of accounting for consumed tool life. (See the Automatic Management table above.) Note that if the tool is a Bore or a Tap, you should select Drill.

Total Life

This field specifies the total amount of tool life. A value greater than 0 enables Tool Life management for the tool. A value of 0 (Off) excludes the tool from Tool Life management. Such a tool is called an “Unmanaged” tool. Unmanaged tools can be shown or hidden by pressing F1. The units of this field is specified in the Units field.

Used

This field is the amount of consumed tool life. When a new tool is first set up, you should initialize this field to 0 indicating zero usage. If the Mode field is set to Auto, this field will automatically be modified during a job run to reflect the accumulated tool usage. The units of this field is specified in the Units field.

Remaining (non-edit)

This is the display of the remaining amount of tool life.

Units

This specifies the units (either distance or Cycles) that will be used and displayed for the Total Life, Used, and Remaining fields. Distance is specified with mm or Inches (as set in the Control Configuration menu – see Chapter 14).

Mode

This specifies the update mode of the Used field -- either Auto or Manual. If this field is set to Auto, then tool activity is monitored during a job run for tool usage which will be automatically accumulated in the updated Used field. (See the Automatic Management table above.)

If this field is set to Manual, no such automatic updates will take place on the Used field. Rather, updates to the Used field will be dependent upon user variable modifications programmed in the G-code program being run. (See the section *Tool Life Management – Using G-Code User Variables* later in this chapter.)

Description

This field contains a text description of the tool. The description will appear in a prompt message on the screen when the CNC software reaches a tool change (M6) during a job run.

Tool Life Management – Effect on Job Run and Backplot

At Start of Job

Tool life expirations will be checked at the beginning of a job run. If any managed tools are expired at the beginning of a job, the following dialog will show up and you will have one of 3 choices to make:

Tool life expired:
T4, T20

F1 = Go to the Tool Life Management menu
F2 = Continue to run job F3 = Cancel job

When a job is first started, the CNC software will not yet know which tools are going to be used in the job until the job is successfully completed. Therefore, the tools listed here will be the list of all expired tools even if they are not going to be used in the job.

At Job Restart

Tool life expirations are also checked upon job restart (i.e. upon encountering M2 or M102). If any tool(s) expired during the previous job run (previous to the M2 or M102), then the dialog that is displayed is similar to that shown above except that the expired tools listed will only be the ones that were used in the job.

At End of Job

When tool life expires during a job, such an event will not cancel the job. Instead, upon successful end of the job the following dialog will be displayed and you will have an opportunity to quickly get to the Tool Life Management menu:

Tool life expired during job:
T20

Go to the Tool Life Management menu?
F1 = Yes F2 = No

This end-of-job dialogue will show only the expired tools that were used in the job.

Using Backplot Graphics to Predict Tool Expirations

You can use Backplot Graphics as a way to predict ahead of time whether or not one or more tools will expire during a job. Simply press **F8 Graph** at the Main Screen or in the Load menu. If the job being graphed will result in an expired tool if it was actually run, then the following message will show up:

Tool life will expire on this job:
T20

Tool Life Management – Using G-Code User Variables

If a tool's Mode field is set to Manual, there will be no updates to the Used field of the Tool Life data during a job run, unless the job's G-code is programmed to modify it.

The following is an example of how a G-code program would modify tool life data. Assuming tool T23's Mode is set to Manual, and its Units is set to Cycles, the following G-code will increment T23's Used Life field by 1 after completing the example_cycle.cnc.

```
M6 T23                ; change tool to T23
M98 "example_cycle.cnc" L1 ; run the cycle 1 time
IF #4201 || #4202 THEN GOTO 100 ; skip to N100 if in backplot or search mode
IF #4120 < 1 || #4120 > 200 THEN GOTO 100 ; skip to N100 if T number is not valid
#[19000+[#4120-1]*5+2] = #[19000+[#4120-1]*5+2] + 1 ; increment current tool's Used Life by 1 cycle
N100                 ; destination of goto's
```

See Chapter 11 for more information about the use of User or System Variables.

Chapter 6

Running a Job

To start the currently loaded job, go to the Main Screen and press the **CYCLE START** button on the jog panel. If your control is not equipped with a jog panel, press **ALT-S** on the keyboard.

Active Job Run Screen with G-code Display

If the Run-Time Graphics option is set to Off, the following screen is displayed while a job is running:

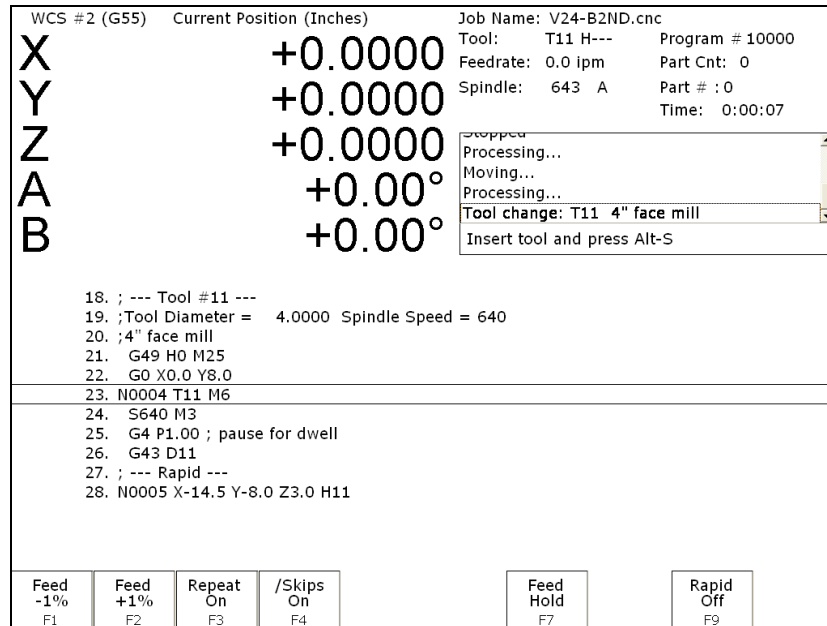

On this screen, the following F-keys are available:

- F1 – Feed (-1%)** Decrease feedrate override by 1%. (Available only if keyboard jogging is active.)
- F2 – Feed (+1%)** Increase feedrate override by 1%. (Available only if keyboard jogging is active.)
- F3 – Repeat On/Off** Toggle the repeat feature for part counting. For more information, see F3 under the Run Menu section later in this chapter.
- F4 – Skips On/Off** Enable/Disable block skips. For more information, see F4 under the Run Menu section later in this chapter.
- F5 – Auto** This key will only appear in Single Block mode. When you press this key, it turns on Auto mode and disables Single Block mode. Once Auto mode is turned on, Single Block cannot be re-enabled unless you stop the job. For more information, see F5 under the Run Menu section later in this chapter.
- F6 – Stops off** This key will only appear if Optional Stops is on. When you press this key, it turns off Optional Stops. Once Optional Stops is turned off, it cannot be re-enabled unless you stop the job. For more information, see F6 under the Run Menu section later in this chapter.
- F7 – Feed Hold** Turn feed hold on/off. (Available only if keyboard jogging is active.)
- F8 – Graph** Switch to run-time graphics screen. This key only appears if the job was started with the run-time graphics option turned on.
- F9 – Rapid On/Off** Turn rapid override on/off.

For information on other keys that are available while a job is running, see Chapter 2.

Run-Time Graphics Screen

When a job is running with Run-Time Graphics set to On, the following screen is displayed:

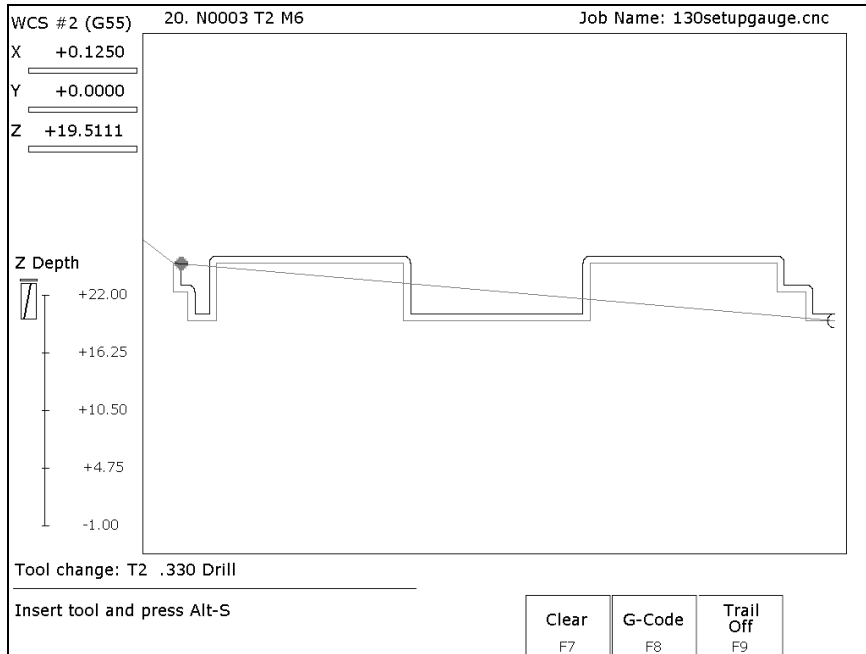

The following keys are available while the job is running in Run Time Graphics.

- F7 – Clear** Clears the trail up to the tool’s current position in the program.
- F8 – G-Code** Switch to the Job Run Screen with G-Code display.
- F9 – Trail On/Off** Turn on/off the tool trail display.

Canceling a Job in Progress

There are three conventional ways to cancel a currently running job (CNC program). When a job is canceled using any of the following methods, the job's progress will be recorded. This allows the user to restart the job using the Resume Job option or the Search and Run option.

CYCLE CANCEL pressing this key while a job is running will cause the control to abort the job currently being run. The control will stop movement immediately, clear all M-functions, and return to the main screen. Hitting the escape key on the keyboard is equivalent to hitting “CYCLE CANCEL.”

TOOL CHECK Pressing this key while a job is running will cause the control to stop the normal program movement. In addition, the Z-axis will be pulled to its home position and all M-functions will be cleared. The control will automatically go to the resume job screen.

EMERGENCY STOP (E-Stop) Pressing the **EMERGENCY STOP** button, while a job is running, will cause the control to abort the job currently being run. The control will stop movement immediately, clear all M-functions, and return to the main screen. Also, the power to all axes will be released.

Resuming a Canceled Job

If a job is canceled using one of the methods described above, it can be resumed in one of three ways:

CYCLE START Pressing the **CYCLE START** button will restart the job at the **BEGINNING** of the part program.

F1 - Resume Job (Located in **F4-Run** menu) Restart the canceled job at or near the point of interruption. See the next section in this chapter entitled “Run menu” for more information.

F2 - Search (Located in **F4-Run** menu) Restart at a specified point in the part program. See the next section in this chapter entitled “Run menu” for more information.

Run menu

Press **F4 - Run** from the main screen to access the Run menu. From this menu, the operator can restart a canceled job or change the way the job will run.

WCS #2 (G55)		Current Position (Inches)		Job Name: V24-B2ND.cnc	
X	+0.0000	Tool: T11 H---		Feedrate: 100% Part Cnt: 10	
Y	+0.0000	Spindle: 0 A		Part #: 0	
Z	+0.0000	<div style="border: 1px solid black; padding: 2px;"> Processing... Stopped Processing... Waiting for PLC operation Stopped Alt-S to start job, Alt-J to jog. </div>			
A	+0.0000				
B	+0.0000				
Run					
Single Block Mode:	Off	Run-Time Graphics:	On		
Optional Stops:	Off				
Block Skips:	On				
Job Repeat:	Off				
Part Count: <input type="text" value="10"/>					
Resume Job F1	Search F2	Repeat On F3	/Skips Off F4	Block F5	Stops F6
				Graph F8	RTG On/Off F10

F1 - Resume Job Access the resume job screen by pressing **F4 - Run** on the main screen to go to the run screen, and then pressing **F1 – Resume Job** in the run screen to go to the resume job screen. If the job was canceled by pressing **TOOL CHECK**, the control will go to the resume job screen automatically. From this screen, the user can modify tool offsets and the tool library, turn block mode on and off, turn optional stops on or off, graph the partially completed job, or start the partially completed job.

The resume job option is not always available. The following situations will cause the resume job option to be unavailable:

- Loading a new job.
- Running a job to completion.
- Parse errors in the job.
- Editing or reposting the job file.
- Loss of power while a job is running.

F2 – Search Invoking this option will bring you to the “Search and Run” menu. This menu will allow you to specify the program line, block number, or tool number at which execution of a program is to begin. Program lines are numbered from the top of the file down with the first line numbered 1. To enter a block number, place an "N" in front of the number. To enter a tool number, place a "T" in front of the number. Pressing **CYCLE START** from here would start the program at the point you specified.

An extra option unique to the “Search and Run” screen is the **F1 – Tool Change** “Do Last Tool Change” function. This key toggles the tool change option as shown on screen. A "YES" tells the control to perform a tool change so that the tool specified for the line or block has the tool indicated in the program. A "NO" uses the currently loaded tool, regardless of what tool is specified for the line or block being searched.

NOTE: You cannot search into a subroutine.

F3 – Repeat On/Off This key toggles the repeat feature for part counting. When part counting is in effect and Repeat is on, the job will be automatically run again until the specified number of parts has been run. The On or Off label indicates the state to which the repeat feature will toggle to when pressed. It does not indicate the current state. The current state is indicated in the user window above.

The **Part Count:** prompt is used to set the Part count. Positive values set the part counter to count up and negative values configure the part count to count down. For example, if 10 is entered in the Part Count prompt, the Part Cnt in the status window changes to 10 and the Part # changes to 0 with an upward arrow indicator. When a job is run and then completes, the Part # will increment to 1. If repeat is on, the job will automatically start again and keep running until the Part # has reached the Part Cnt. If a –10 is entered in the Part Count prompt, the Part Cnt in the status window changes to 10 and the Part # changes to 10 with a downward arrow indicator. When a job is finished, the Part # will be decremented to 9. If repeat is on, the job will automatically start again and keep running until the Part # has reached 0.

F4 - /Skips On/Off This function toggles the block skip feature. When block skipping is on, G-code lines that start with a forward slash character ‘/’ are skipped, i.e., they are not processed. Note that because of the way a job is processed (in a pre-processed buffered fashion) the effect of this key may be delayed if you press it while a job is running. The On or Off label indicates the state to which the /Skips feature will toggle to when pressed. It does not indicate the current state. The current state is indicated in the user window above.

F5 - Block Mode Turns single block mode on and off. This is similar to pressing **AUTO/BLOCK**. If Single Block mode is on, the CNC software will stop after each block in your part program and wait for you to press **CYCLE START**. Note that Auto mode is the default mode. If you use this key to turn on Single Block mode and then run a job, Auto mode will be re-instated when the job ends. The current state of this setting is indicated in the user window above.

F6 - Optional Stops Turns optional stops on and off. If optional stops are on, any M1 codes that appear in your program will cause a wait for **CYCLE START** (just like M0). If optional stops are off, M1 codes will be ignored. Note that the default mode for Optional Stops is off. If you use this key to turn on Single Block mode and then run a job, Optional Stops will be set to off when the job ends. The current state of this setting is indicated in the user window above.

F8 – Graph Graphs the part. For more information, see the "*F8 - Graph*" section in chapter 3. If this feature is invoked from the Run and Search screen or the Resume Job screen, then the graphics will show exactly where the searched line or block begins. Dotted lines indicate the portion of the part that is skipped. Solid lines indicate the portion of the part that will be machined.

F9 – Rapid On/Off This function key toggles Rapid Override. The On or Off label indicates the state to which the Rapid Override feature will toggle when pressed. In the Rapid Override On state, the speed of rapid moves (G0) can be adjusted by the Feedrate Override knob. In the Rapid Override Off state, the speed of rapid moves will be at full speed (max rate).

F10 – RTG On/Off This function key toggles the Run-Time Graphics option. If the option is turned on, Run-Time Graphics automatically starts when the **CYCLE START** button is pressed. This option must be turned on for Run-Time Graphics to be used. If the option is turned off, Run-Time Graphics cannot be started while a job is running.

Power Feed

Press **F4 - Feed** from the Setup menu to access the Power Feed screen. This screen is used to command axis movement. All the operations available on the Power Feed screen may also be performed in MDI with the appropriate M and G codes.

F1 - Absolute Power Feed Press **F1 - ABS** to move an axis to an absolute position, at a specified feedrate.

F2 - Incremental Power Feed Press **F2 - INC** to move an axis an incremental distance, at a specified feedrate.

F3 - Free XY Press **F3 - Free** to release power to the X and Y motors, allowing you to use your machine manually for these two axes.

F4 - Power XY Press **F4 - Power** to apply power to the X and Y motors, allowing you to use your machine with the jog panel for these two axes.

Chapter 7

The Utility Menu

To get to the Utility Menu, press **F7 - Utility** at the CNC software Main Screen. The model will vary depending on your M-Series Control model.

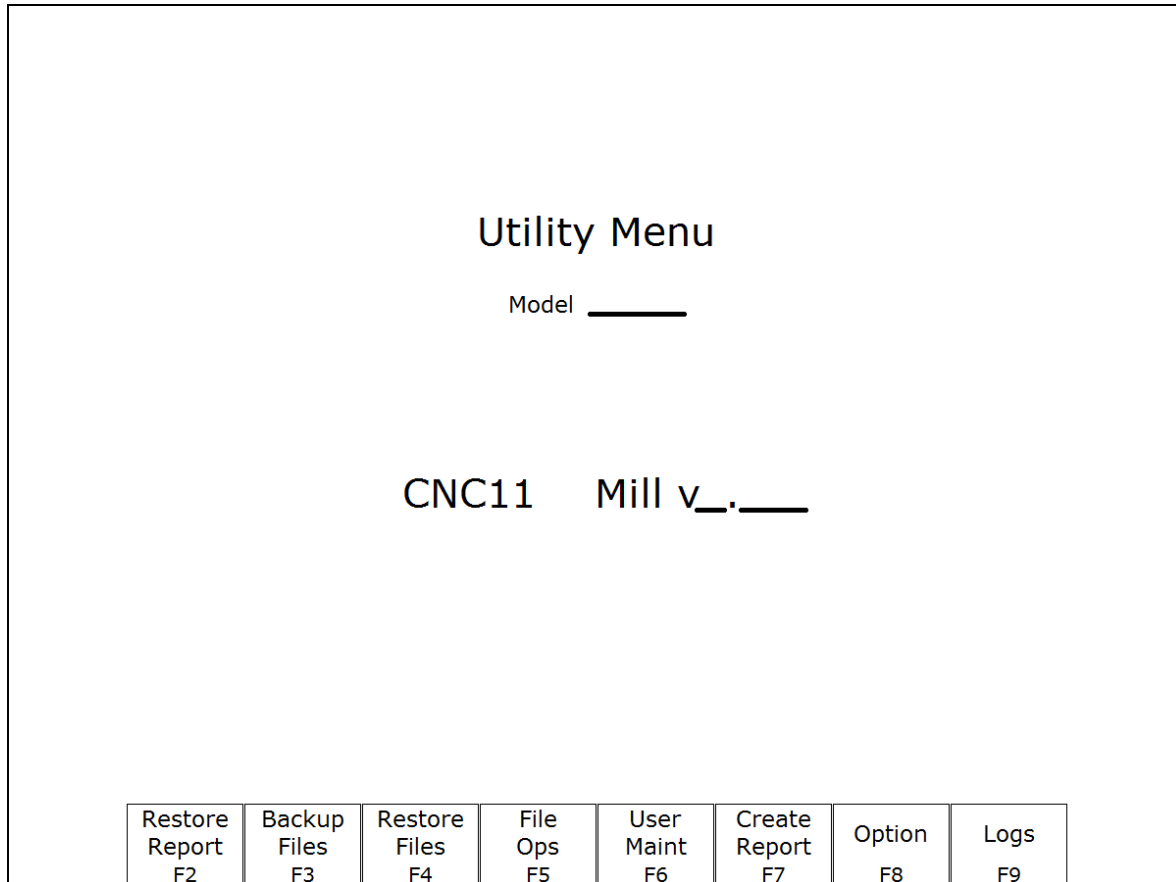

F2 – Restore Report This option is used primarily for restoring a system configuration from a previously saved *report.zip* file (See **F7 – Create Report**).

F3 – Backup Files This creates an archive file “cnc_backup.zip” containing CNC program files, Intercon part program files, MillWrite engraving files, and digitized output files from the following directories and their subdirectories: ncfiles directory, c:\intercon, c:\mw, and any other directories mentioned in the pathm.ini configuration file.

F4 – Restore Files Use this option to restore the data previously backed up with **F3 – Backup Files**. (Note that this feature will not work with backups created by control software prior to version 3.04.)

F5 – File Ops Use this menu to perform file and directory operations such as: Importing and Exporting (copying) files to and from the control, rename or delete files, create or delete directories.

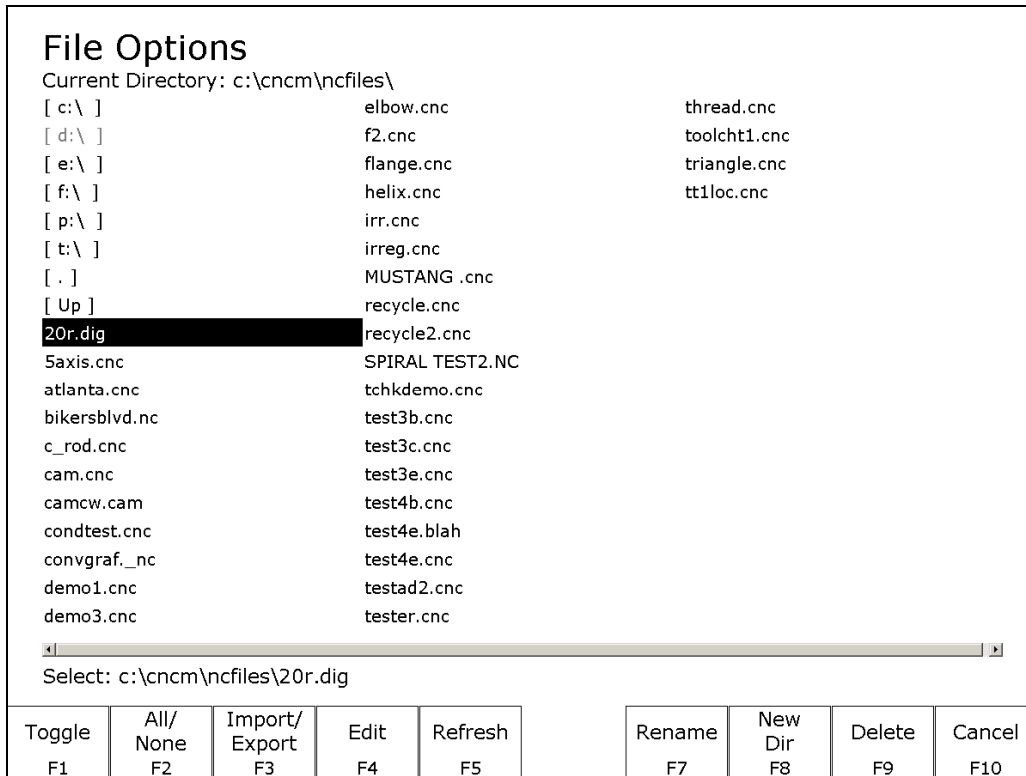

- F1 – Toggle** Press once to select or press again to unselect a single file.
- F2 – All /None** Press once to select all or press again to unselect all files.
- F3 – Import/Export** Import or Export selected files.
- F4 – Edit** Opens selected file in editor.
- F5 – Refresh** Refresh file list. Use after inserting a new USB storage device
- F7 - Rename** Rename selected file or directory.
- F8 - New Dir** Create a new directory in the current folder.
- F9 - Delete** Deletes selected file or directory.
- Page Up** Move the cursor backward one page.
- Page Down** Move the cursor forward one page.
- End** Select the last file in the list.
- Home** Select the first file in the list.
- Arrow Keys** Move the cursor in the selected direction.

F6 – User Maint

Use this menu to perform user maintenance such as checking an axis for excessive drag or setting backlash

F1 – Drag The Drag Factor utility is used to determine if an axis has an excessive amount of drag. To run a drag test, use the **F1** key to select the axis which you wish to test, position the axis at or near the home position and press **CYCLE START**. The axis will move back to the home switch then traverse the entire range of travel for the axis moving to the opposite limit and returning to home while moving the slow jog rate. If excessive friction (drag) is encountered an error message will be displayed. When the test completes, use **F8-Graph** to display the results. The red horizontal lines indicate the bounds acceptable limits for the machine as it is currently configured.

F2 - Lash (Backlash Compensation) In order to insure an accurate measurement always set the backlash compensation in the control to zero before attempting to measure the physical lash in an axis.

F7 – Create Report Generates a backup of system configuration files called *report.zip* and copies it to the specified location. Your dealer may then use this file for servicing and troubleshooting purposes. To restore the configuration files from the report disk, press **F2 – Restore Report** from the Utility menu.

F8 – Options Shows the software options that you have purchased or added to your control. On this screen you can also enter unlock codes for software options that you have purchased. This page will also display the PLC programs, PIC type, and System ID #.

F9 – Logs Shows the messages and errors that have been logged by the control.

F1 – Errors Displays the error/message log. Use **PgUp, PgDn, Home, & End** to view and **ESC** to exit.

F2 – Stats Displays counts of errors logged. Use **PgUp, PgDn, Home, & End** to view and **ESC** to exit.

F3 – Export Exports the log to a destination of your choosing.

Chapter 8

Digitize

(F9 from Main Menu)

WCS #1 (G54)	Current Position (Inches)	Job Name: ms1.cnc			
X	+0.0000	Tool: T8 H---			
Y	+0.0000	Feedrate: 111% 0.0 ipm			
Z	+10.0000	Spindle: 0 A			
			335 Emergency stop released		
<div style="display: flex; justify-content: space-around; align-items: center;"> <div style="text-align: center;"> Grid </div> <div style="text-align: center;"> Radial </div> <div style="text-align: center;"> Contour </div> <div style="text-align: center;"> Probe </div> <div style="text-align: center;"> Wall Following </div> </div>					
Grid F1	Radial F2	Contr F3	Probe F4	Dig to CAD F6	Wall Following F8

The Digitize feature of the CNC software can be used to digitize surfaces in a variety of scenarios. The digitizing process creates a file with M & G codes that represent the digitized surface. If the digitizing probe tip is chosen to match the milling cutter size, the digitized file can be loaded and run to produce an exact copy of the digitized part.

- | | |
|----------------------------|--|
| F1 – Grid | Digitize rectangular surface area. |
| F2 – Radial | Digitize inside of a bore. |
| F3 – Contour | Digitize inside or outside contour. |
| F4 - Probe | Select from the Probing Cycles (See Chapter 9 of this manual). |
| F6 – Dig to CAD | Export digitized files for use with a CAD/CAM system. |
| F8 – Wall Following | Digitize inside and/or outside contour . |

Grid Digitize

(F1 from Digitize Menu)

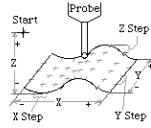
WCS #1 (G54)	Current Position (Inches)	Job Name: a.cnc																											
X	-0.2695	Tool: T0 H1																											
Y	+1.9986	Feedrate: 19% 0.0 ipm																											
Z	+3.0000	Spindle: 0 A																											
Grid Digitizing Stall detection disabled																													
<ol style="list-style-type: none"> 1) Jog Probe Tip to Maximum Height 2) Jog Probe Tip to Surface Corner 3) Edit the Digitize Parameters 4) Press CYCLE START to begin 	<table style="width: 100%; border-collapse: collapse;"> <tr> <td>Type:</td> <td style="text-align: right;">Grid</td> </tr> <tr> <td>X Patch Length:</td> <td style="text-align: right;">1.0000</td> </tr> <tr> <td>X Step Over:</td> <td style="text-align: right;">0.0100</td> </tr> <tr> <td>Y Patch Width:</td> <td style="text-align: right;">1.0000</td> </tr> <tr> <td>Y Step Over:</td> <td style="text-align: right;">0.0100</td> </tr> <tr> <td>Z Maximum Depth:</td> <td style="text-align: right;">1.0000</td> </tr> <tr> <td>Z Step Up:</td> <td style="text-align: right;">0.1000</td> </tr> <tr> <td>Axis to Move First:</td> <td style="text-align: right;">X</td> </tr> <tr> <td>Digitize File Name:</td> <td></td> </tr> <tr> <td>Replay Feedrate:</td> <td style="text-align: right;">3.0000</td> </tr> <tr> <td>Multiple Patch:</td> <td style="text-align: right;">No</td> </tr> <tr> <td>Replay Pattern:</td> <td style="text-align: right;">Zig Zag</td> </tr> <tr> <td>Probe Diameter:</td> <td style="text-align: right;">0.2362</td> </tr> </table>			Type:	Grid	X Patch Length:	1.0000	X Step Over:	0.0100	Y Patch Width:	1.0000	Y Step Over:	0.0100	Z Maximum Depth:	1.0000	Z Step Up:	0.1000	Axis to Move First:	X	Digitize File Name:		Replay Feedrate:	3.0000	Multiple Patch:	No	Replay Pattern:	Zig Zag	Probe Diameter:	0.2362
Type:	Grid																												
X Patch Length:	1.0000																												
X Step Over:	0.0100																												
Y Patch Width:	1.0000																												
Y Step Over:	0.0100																												
Z Maximum Depth:	1.0000																												
Z Step Up:	0.1000																												
Axis to Move First:	X																												
Digitize File Name:																													
Replay Feedrate:	3.0000																												
Multiple Patch:	No																												
Replay Pattern:	Zig Zag																												
Probe Diameter:	0.2362																												
																													
			<div style="border: 1px solid black; padding: 2px; display: inline-block;">Save</div> <div style="border: 1px solid black; padding: 2px; display: inline-block;">F10</div>																										

Grid Digitize Run Setup

To set up a digitizing run, edit the parameters shown and then press **CYCLE START**. The control will move through the area to be digitized in a rectangular pattern. At each X-Y point in the pattern, it will measure the Z height of the sample surface, and record the coordinates in the data file.

Digitizing begins at the current tool position when the **CYCLE START** button is pressed. This position should be in one corner of the digitize area, at a Z position higher than any point on the surface.

Grid Digitize Parameters

Type: This sets the algorithm for digitizing: either regular Grid or Surface Following.

X Patch Length: The length of the area to be digitized, along the X-axis. A positive value will cause digitizing to proceed in the X+ direction from the starting point; a negative value will cause digitizing to proceed in the X- direction. If the value is 0, then digitizing will collect just one stripe along Y.

X Step Over: The distance to move between points on the X-axis. A smaller value should be used for a fine digitize along the X-axis. A larger value should be used for a rough digitize along the X-axis. This distance should be a positive incremental value.

Y Patch Width: The width of the area to be digitized, along the Y-axis. A positive value will cause digitizing to proceed in the Y+ direction from the starting point; a negative value will cause digitizing to proceed in the Y- direction. If the value is 0, then digitizing will collect just one stripe along X.

Y Step Over: The distance to move between points on the Y-axis. A smaller value should be used for a fine digitize along the Y-axis. A larger value should be used for a rough digitize along the Y-axis. This distance should be a positive incremental value.

Z Maximum Depth: The maximum distance the Z-axis moves below the starting height. If the probe does not contact the surface at the maximum depth, that data point will be recorded as being *at* the maximum depth, and digitizing will proceed with the next point.

Z Step Up: The distance the Z-axis moves up after making contact, before the control attempts to move X or Y. A small value should be used when digitizing parts with gentle slopes; a larger value should be used when digitizing parts with many steep walls.

Axis to Move First: The axis (either X or Y) which moves all the way across the digitize area with each pass.

Digitize File Name: The base name of the output file in which the digitize data is stored. An extension of *.dig* will automatically be appended to the name for replay as a CNC job.

Replay Feedrate: The feedrate to include with the G1 command on the first line of the data file. If the data file is run as a CNC program, this is the feedrate at which the machine will retrace the digitized surface.

Multiple Patch: Indicates whether or not this digitizing is a continuation of an earlier digitizing. Choose NO if the current digitizing is the first or only digitize run for the part to be digitized. Choose YES if the current digitizing is not the first digitize run for the part. If Yes is selected, specify the name of a digitize file of a previous multiple patch.

Replay Pattern: Indicates the replay movement pattern. If ZIG ZAG is selected, the replay pattern will alternate between positive and negative directions on each successive pass. If ONE WAY is selected, the replay pattern will maintain a constant "one-way" direction throughout the playback.

Probe Diameter: Indicates the probe tip diameter.

Grid Digitize Notes

1. A guide to the possible grid digitizing paths is as follows:

ZIG-ZAG REPLAY PATTERN

X INDICATES START POINT

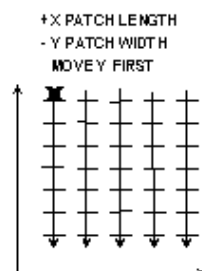
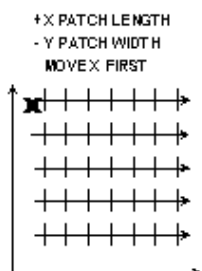
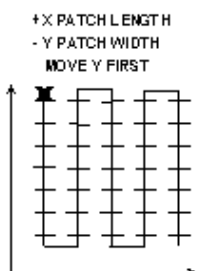
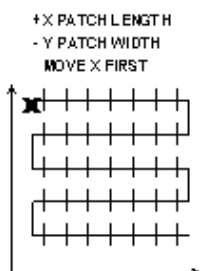
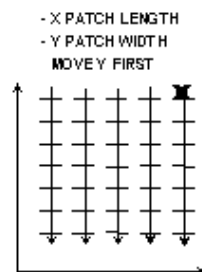
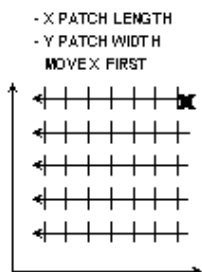
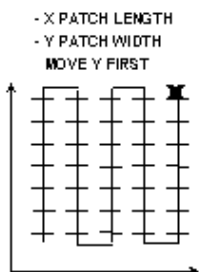
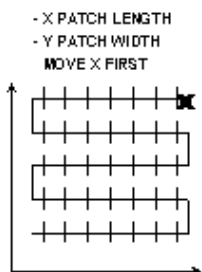
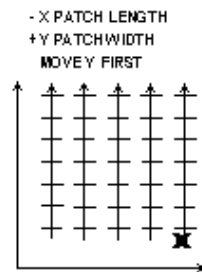
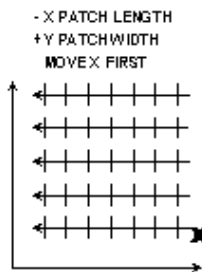
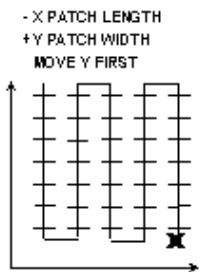
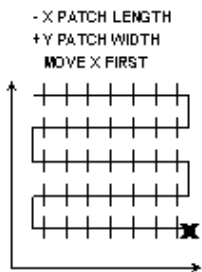
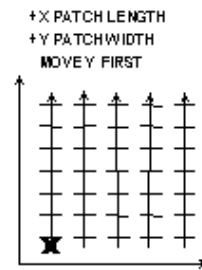
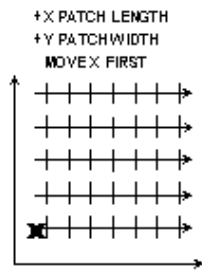
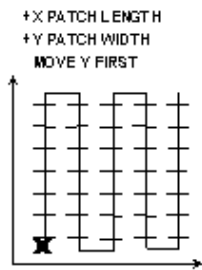
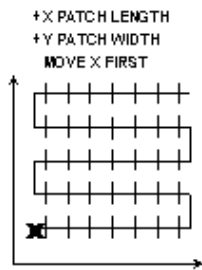

ONE-WAY REPLAY PATTERN

X INDICATES START POINT

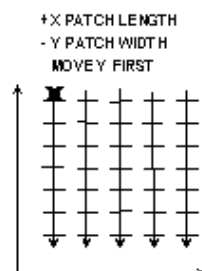
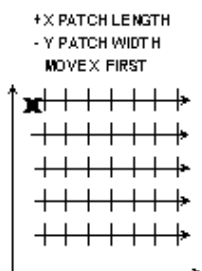
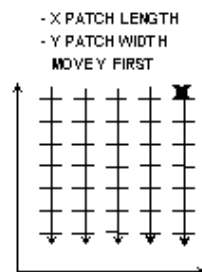
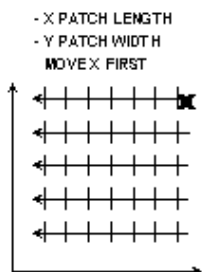
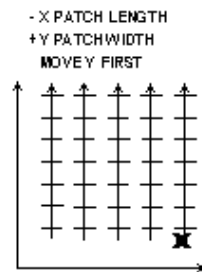
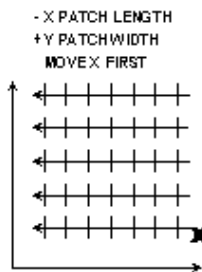
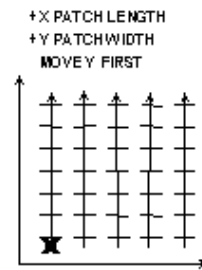
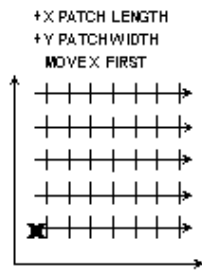

2. A digitizing patch can be located anywhere in the coordinate system. The digitizing starting point is referenced from the part zero. For example, setting up digitizing, as shown in the figure on the right below, will record the first point at (X5, Y5, Z1) and the last point at (X7, Y7, Z1). If the digitizing replay starting point is desired to be at the part zero be sure to set the part zero equal to the digitizing start point, as shown in the figure on the left below. This orientation will record the first point at (X0, Y0, Z0) and the last point at (X2, Y2, Z1). For more information on part setup see Chapter 4.

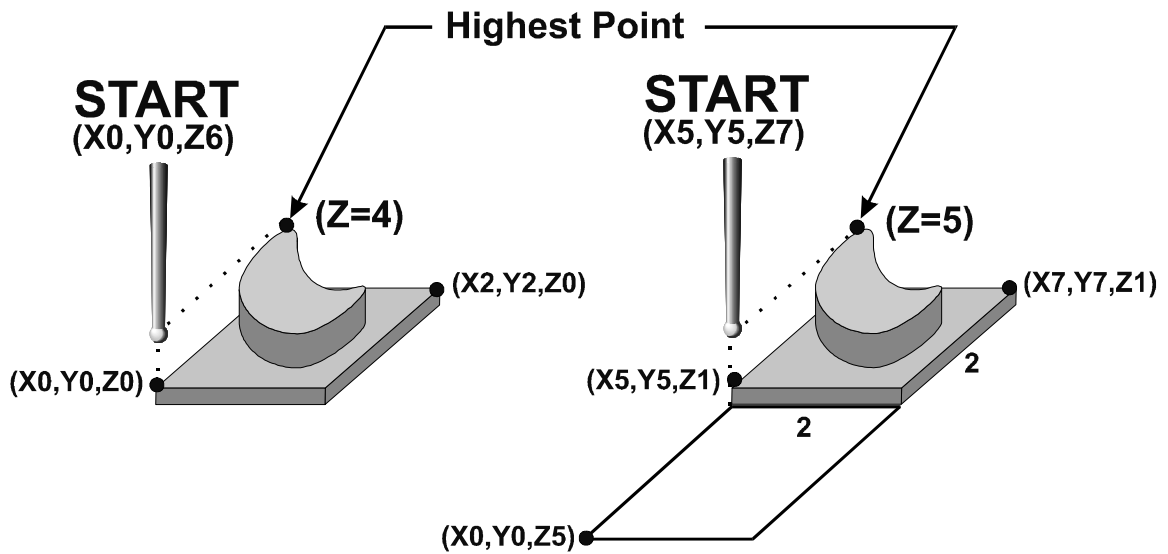

3. A good technique for calculating Z maximum depth is to touch off the lowest surface of the part to be digitized and set the part zero's Z value to Z0. Then jog the probe tip to a point higher than the highest surface of the part to be digitized. Note the displacement in the Z-axis. Again, set this Z height to Z0 and use the noted displacement for the Z maximum depth.

4. Multiple patches are useful in the following situations: completing a canceled digitize run, digitizing parts with large areas that contain nothing to be digitized (shown below), and patching vertical walls to eliminate scallops caused by the cutting tool.

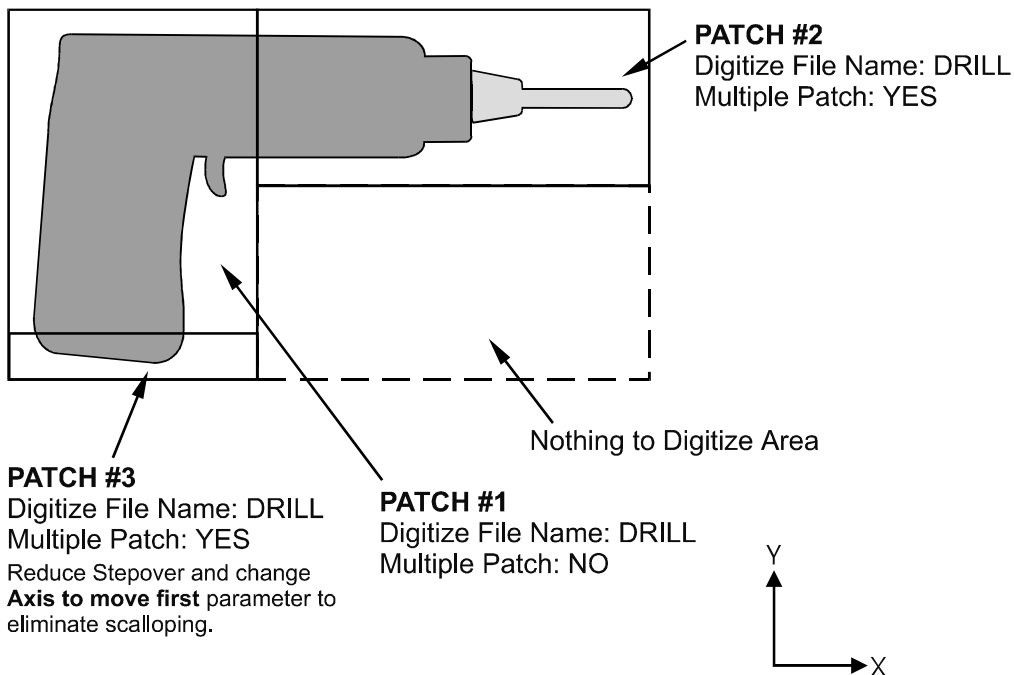

The drill shown in the previous example is L-shaped. Therefore, it can be digitized faster and more efficiently using three rectangular patches than digitizing the complete area with a single patch.

Digitizing the entire part and then adding multiple small patches along the walls can avoid vertical wall scalloping. If a vertical wall extending along the X axis needs to be cleared of scallops, just add a small patch running the length of the wall. Set the "Axis to Move First" parameter to Y. This will clear the scallops.

Radial Digitize (F2 from Digitize Menu)

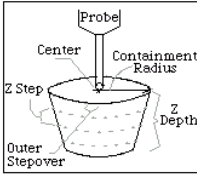
WCS #1 (G54)	Current Position (Inches)	Job Name: flange.cnc																						
X Y Z	+6.2140	Tool: T1 H---																						
	+0.0000	Feedrate: 100%																						
	+0.0000	Spindle: 0 M Coolant																						
<div style="display: flex; justify-content: space-between;"> <div style="width: 45%;"> <p>Radial Digitizing</p> <ol style="list-style-type: none"> 1) Jog Probe Tip to Starting Height 2) Jog Probe Tip to Center of Well 3) Edit Radial Digitize Parameters 4) Press CYCLE START to begin </div> <div style="width: 50%;"> <table style="width: 100%; border-collapse: collapse;"> <tr> <td style="padding: 2px;">Containment Radius:</td> <td style="text-align: right; padding: 2px;">1.0000</td> </tr> <tr> <td style="padding: 2px;">Z Patch Depth:</td> <td style="text-align: right; padding: 2px;">1.0000</td> </tr> <tr> <td style="padding: 2px;">Z Step:</td> <td style="text-align: right; padding: 2px;">0.0100</td> </tr> <tr> <td style="padding: 2px;">Outer Stepper:</td> <td style="text-align: right; padding: 2px;">0.0100</td> </tr> <tr> <td style="padding: 2px;">Replay Pattern:</td> <td style="text-align: right; padding: 2px;">Zig Zag</td> </tr> <tr> <td style="padding: 2px;">Replay Feedrate:</td> <td style="text-align: right; padding: 2px;">3.0000</td> </tr> <tr> <td style="padding: 2px;">Digitize File Name:</td> <td style="padding: 2px;"></td> </tr> <tr> <td style="padding: 2px;">Containment Angle:</td> <td style="text-align: right; padding: 2px;">Full</td> </tr> <tr> <td style="padding: 2px;">Multiple Patch:</td> <td style="text-align: right; padding: 2px;">No</td> </tr> <tr> <td style="padding: 2px;">Move Between Levels:</td> <td style="text-align: right; padding: 2px;">Clearance</td> </tr> <tr> <td style="padding: 2px;">Clearance Height:</td> <td style="text-align: right; padding: 2px;">0.0100</td> </tr> </table> </div> </div>			Containment Radius:	1.0000	Z Patch Depth:	1.0000	Z Step:	0.0100	Outer Stepper:	0.0100	Replay Pattern:	Zig Zag	Replay Feedrate:	3.0000	Digitize File Name:		Containment Angle:	Full	Multiple Patch:	No	Move Between Levels:	Clearance	Clearance Height:	0.0100
Containment Radius:	1.0000																							
Z Patch Depth:	1.0000																							
Z Step:	0.0100																							
Outer Stepper:	0.0100																							
Replay Pattern:	Zig Zag																							
Replay Feedrate:	3.0000																							
Digitize File Name:																								
Containment Angle:	Full																							
Multiple Patch:	No																							
Move Between Levels:	Clearance																							
Clearance Height:	0.0100																							
<div style="display: flex; align-items: center;"> <div style="width: 30%; text-align: center;">  </div> <div style="width: 65%;"> <p style="margin-left: 20px;">Center</p> <p style="margin-left: 20px;">X: Not</p> <p style="margin-left: 20px;">Y: Set</p> </div> </div>																								
Center F1	Partial F2	Save F10																						

Setting up a Radial Digitize Run

To set up a digitize run, edit the parameters shown. Jog the probe tip to the starting height and to the center of the bore to be digitized. Then press **F1 - Center** to define the center position for digitizing. This center position will be used as the center of all radial digitizing runs until you leave the radial digitize menu or redefine the center. If you are using a full angle, you can now press **CYCLE START** to begin digitizing. If you have specified partial angle, press **F2 - Partial** to define the partial angle (see setting the partial angle section in this chapter). After defining the partial angle, pressing **CYCLE START** will start the digitize run.

WARNING: The probe must be able to retreat to the center from any position on the digitize surface. If the digitize surface contains features that do not allow for the probe to exit after entering, a probe crash may occur! See radial digitize note 2 later in this section.

Radial Digitize Parameters

Containment Radius: The maximum distance from the center position to look for a digitize data point. This parameter is used to contain the probe within a circle with this radius centered at the center position. If the probe does not contact the surface before reaching the maximum radius that data point will be recorded as being *at* the maximum radius, and digitizing will proceed with the next point.

Z Patch Depth: The depth of the patch to be digitized, along the Z-axis. A positive value will cause digitizing to proceed in the Z+ direction from the starting point; a negative value will cause digitizing to proceed in the Z- direction.

Z Step: The distance to move between points on the Z-axis. A smaller value should be used for a fine digitize along the Z-axis. A larger value should be used for a rough digitize along the Z-axis. This distance should be a positive incremental value.

Outer Stepover: The distance to move between points on one contour. A smaller value should be used for a fine digitize along any one contour. A larger value should be used for a rough digitize along any one contour. This distance should be a positive incremental value.

Replay Pattern: Indicates the replay movement pattern. If Zigzag is selected, the replay pattern will alternate between positive and negative angle directions (CW and CCW) on each successive contour. If CW or CCW is selected, the replay pattern will maintain a constant angle direction throughout the playback.

Replay Feedrate: The feedrate to include with the G1 command on the first line of the data file. If the data file is run as a CNC program, this is the feedrate at which the machine will retrace the digitized surface.

Digitize File Name: The base name of the file in which the digitize data is stored. The file has an extension of *.dig* for CNC replay.

Containment Angle: Indicates whether or not the digitizing is to follow a full circle or a partial sector. Choose **Full** if 0 to 360 degrees is desired. Choose **Partial** if some other angles are needed. These partial angles can then be changed later (see setting the Partial Digitizing Sector Setup section that follows).

Multiple Patch: Indicates whether or not this digitizing is a continuation of an earlier digitizing. Choose **No** if the current digitizing is the first or only digitize run for the part to be digitized. Choose **Yes** if the current digitizing is not the first digitize run for the part. If **Yes** is selected, specify the name of a digitize file of a previous multiple patch.

Move Between Levels: This field is enabled only if **Partial** and **CCW** or **CW** option is selected. It indicates the move between Z levels on replay of a partial sector radial digitize file. This move may now be done in three different ways: **Clearance**, which goes to the clearance height as in previous versions, **Center**, which goes to the digitizing center and then to the Z level of the next pass, and **Direct**, which goes directly to the starting point of the next pass.

Clearance Height: This field is enabled only if **Partial**, **CCW** or **CW** replay pattern, and **Clearance Move** type option is selected. This distance indicates the clearance height needed to move the cutter from the end of one contour to the beginning of the next contour. This distance should be a positive value.

Radial Digitize Notes

1. A guide to possible radial digitizing paths is as follows:

FULL CONTAINMENT ANGLE ONE WAY REPLAY PATTERN

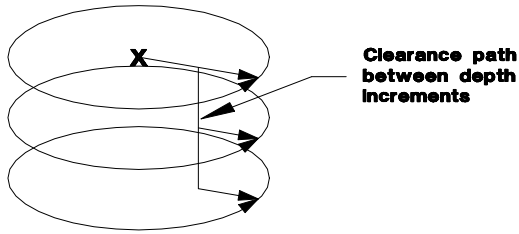

FULL CONTAINMENT ANGLE ZIG ZAG REPLAY PATTERN

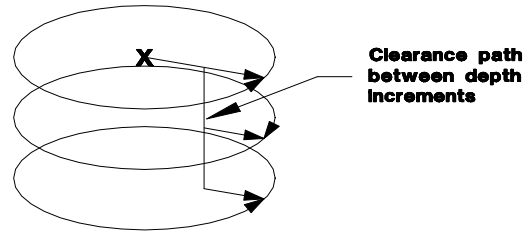

PARTIAL CONTAINMENT ANGLE ONE WAY CLEARANCE REPLAY PATTERN

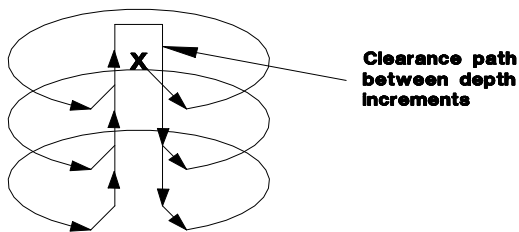

PARTIAL CONTAINMENT ANGLE ZIG ZAG DIRECT REPLAY PATTERN

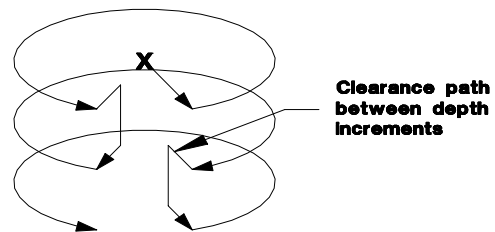

2. When radial digitizing, make sure the probe can fully retract to the center position without obstructions. Observe the two parts below. The cross section on the left has no obstructions that could keep the probe from full retraction to the center position. The cross section on the right does not allow the digitizing to retract to the center in **Area A**. This area will cause a probe crash; single patch digitizing of parts such as this should be avoided. Use 2 or more patches to digitize the part on the right (in this case, you could divide the part in half horizontally, and do each half separately).

IDEAL PART

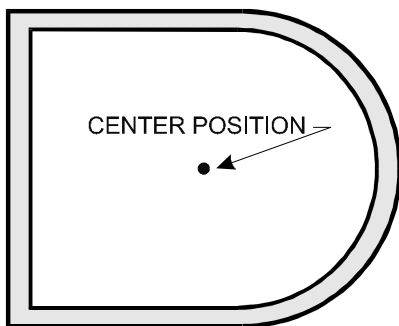

PROBLEM PART

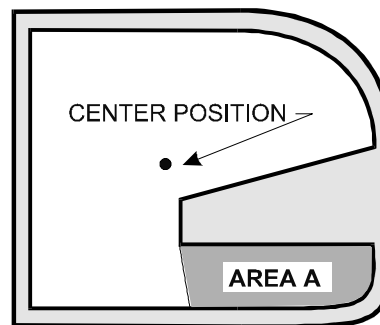

Partial Digitizing Sector Setup

If you set the Radial Digitize Containment Angle to “Partial” then you must set up the Digitizing Setup by pressing **F2 - Partial** from the CNC software Radial Digitize Screen.

WCS #1 (G54) Current Position (Inches) Job Name: flange.cnc

X +6.2140 Feedrate: 100%

Y +0.0000 Spindle: 0 M

Z +0.0000 Coolant

Processing...

Press ESC to cancel

Partial Digitizing Sector

1) Edit the angle fields on the right, OR
Jog to the start or end point of the
sector, then use Start (F1) or End (F2) to
set the start or end points.

2) Press F10 to Save changes or ESC to exit.

Start Angle: 0.00

End Angle: 45.00

Start F1 End F2 Save F10

The partial sector can be setup one of two methods:

One method is by editing the start and end angles directly. The start angle is referenced from zero degrees and defines the beginning of the digitizing sector. The end angle is referenced from zero degrees and defines the end of the digitizing sector.

The second method involves jogging the probe tip and touching off the digitize surface. By moving the probe tip to positions on the digitizing surface, one can set the angles. To set the start angle, jog the probe tip to the position on the digitizing surface where the digitizing is to begin and press **F1 - Start** to define this as the start angle. * Notice that the picture of the sector and the start angle's value change to reflect these settings. To define the end angle, follow the procedure above but press **F2 - End** instead to set the end angle.

Regardless of the method used to define the start and end angles, pressing **F10 - Save** saves the angles and exits back to the radial digitize menu. Pressing **ESC** will return to the radial digitize menu without making changes to the start and end angles.

Contour Digitize

(F3 from Digitize Menu)

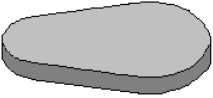
WCS #1 (G54)	Current Position (Inches)	Job Name: flange.cnc																							
X	+6.2140	Tool: T1 H---																							
Y	+0.0000	Feedrate: 100%																							
Z	+0.0000	Spindle: 0 M																							
		Coolant																							
<div style="border: 1px solid black; height: 40px; width: 100%; margin: 5px 0;"></div>																									
Contour Digitizing																									
<ol style="list-style-type: none"> 1) Jog probe tip to center of part. 2) Press F1 to define center of part. 3) Jog probe to start pt. 4) Press CYCLE START to begin 	<table style="width: 100%; border-collapse: collapse;"> <tr> <td>Copy Type</td> <td style="text-align: right;">CAM</td> </tr> <tr> <td>X Patch Length:</td> <td style="text-align: right;">0.0000</td> </tr> <tr> <td>Y Patch Width:</td> <td style="text-align: right;">0.0000</td> </tr> <tr> <td>Axis Step</td> <td style="text-align: right;">0.0100</td> </tr> <tr> <td>Digitize File Name:</td> <td></td> </tr> <tr> <td>Replay Feedrate:</td> <td style="text-align: right;">10.0000</td> </tr> <tr> <td>Plunge Rate</td> <td style="text-align: right;">10.0000</td> </tr> <tr> <td>Z Surface Height</td> <td style="text-align: right;">0.0000</td> </tr> <tr> <td>Z Clearance</td> <td style="text-align: right;">0.1000</td> </tr> <tr> <td>Z Depth</td> <td style="text-align: right;">0.0100</td> </tr> <tr> <td>Z Depth Increment</td> <td style="text-align: right;">0.0100</td> </tr> <tr> <td>Probe Diameter:</td> <td style="text-align: right;">0.1250</td> </tr> </table>	Copy Type	CAM	X Patch Length:	0.0000	Y Patch Width:	0.0000	Axis Step	0.0100	Digitize File Name:		Replay Feedrate:	10.0000	Plunge Rate	10.0000	Z Surface Height	0.0000	Z Clearance	0.1000	Z Depth	0.0100	Z Depth Increment	0.0100	Probe Diameter:	0.1250
Copy Type	CAM																								
X Patch Length:	0.0000																								
Y Patch Width:	0.0000																								
Axis Step	0.0100																								
Digitize File Name:																									
Replay Feedrate:	10.0000																								
Plunge Rate	10.0000																								
Z Surface Height	0.0000																								
Z Clearance	0.1000																								
Z Depth	0.0100																								
Z Depth Increment	0.0100																								
Probe Diameter:	0.1250																								
	<p style="text-align: center;">Center</p> <p>X: Not</p> <p>Y: Set</p>	<p style="text-align: center;">Press SPACE to change</p>																							
<div style="border: 1px solid black; padding: 5px; display: inline-block;">Center F1</div>		<div style="border: 1px solid black; padding: 5px; display: inline-block;">Save F10</div>																							

Contour Digitize Run Setup

To set up a digitizing run, jog the probe tip to the center of the part and hit **F1 - Center** to assign that as your center point.

Select **CAM** for a true CAM shape contour, or **Wall** for irregular shapes for wall following. Enter the rest of the parameters for the part and digitizing job as shown below.

Jog the probe to a starting point and press **CYCLE START**. The control will move the probe toward the center line in the +/- X direction until it comes into contact with the part. At each point of contact, the X and Y coordinates will be recorded in the data file.

The probe will continue around the contour until it returns to the starting point to complete the cycle. Based on the starting point, and the first point of contact, the digitize software will determine if the contour is internal or external.

Important note: When probing an external contour, make sure the probe comes in contact with part on the first move. If it doesn't, the software will compensate to the outside of the part as if it were an internal contour causing your part to come out larger than you want it to be.

Contour Digitize Parameters

Copy Type: Toggle between CAM or Wall. Use CAM for regular shapes (no extreme direction changes) and use Wall following for contours with irregular shapes. See example below.

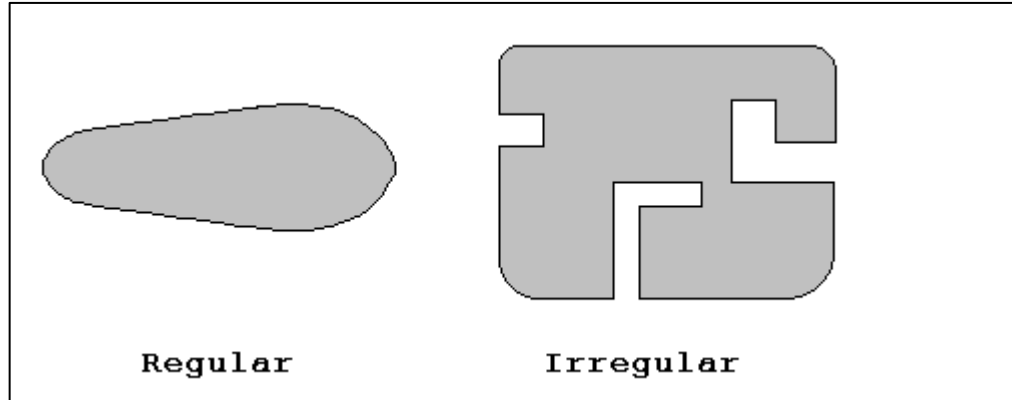

X Patch Length: The length of the contour to be digitized, along the X-axis.

Y Patch Width: The width of the contour to be digitized, along the Y-axis.

Axis Step Over: The distance to pull back away from the surface in the X and/or Y direction. A larger value should be used for a rough digitize along the Y-axis. This distance should be a positive incremental value.

Digitize File Name: The base name of the file in which the digitize data is stored. The file has an extension of .cam for CNC replay and is stored in the c:\cncm\ncfiles directory.

Replay Feedrate: The feedrate to include with the G1 command on the first line of the data file. If the data file is run as a CNC program, this is the feedrate at which the machine will retrace the digitized surface.

Plunge Rate: The feedrate the Z axis plunges between successive depth passes.

Z Surface Height: Surface height of material for reproduction of digitized parts.

Z Clearance: Clearance to rapid to above surface of part during replay.

Z Depth: Depth of the part as measured from the surface height.

Z Depth Increment: Depth of cut for each Z step of the part.

Probe Diameter: Diameter of probe tip used to digitize the part.

Contour Digitize Notes

Contour digitizing creates an M&G code file with a .cam extension. The structure of the .cam file starts with a header of comments indicating some of the parameters used when digitizing the contour. Next is the contour itself, which is outputted as a subprogram. The M&G codes are preceded by an O9800 (start of subprogram) and followed by an M99 (end of subprogram). The end of the .cam file contains the initial positioning moves and a call to the contour subprogram (G65 P9800).

Probing direction: When starting the digitizing cycle, choose a starting point where the X travel will contact a point on the cam on the Y axis. The probe tip will move toward the center line in the X direction until it contacts the cam, then will move either clockwise or counterclockwise around the cam, depending on which quadrant you started the cycle (see Table 1).

Table 1 – Probe direction by starting quadrant

X	Y	Probe travels
-	-	CW
-	+	CCW
+	+	CW
+	-	CCW
-	0	CW
+	0	CCW

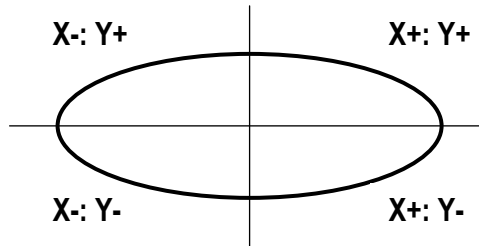

If the probe bypasses a contact point on the Y axis, it will continue moving in the X direction across the center line until it reaches the patch length limit and faults out.

Canceling a job: Unlike grid or radial digitizing if you cancel a contour operation before it is completed you will not be able to restart the contour at the point of interruption to continue the cycle. You will need to start over.

Before running a job: Before running a job created by contour digitizing, you will need to add some information to the file to define any required tool change, cutter compensation and height offset commands.

1. Do a search in the G code for the phrase “Add Comp Here.”
2. Refer to the descriptions of G40, G41 and G42 in Chapter 12.
3. Add the proper G code to the file after the “Add Comp Here” prompt.
4. Save the file, and run your job.

Wall Following Digitizing (F8 from Digitize Menu)

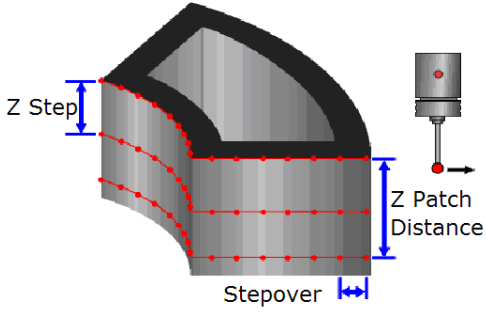
WCS #1 (G54)	Current Position (Inches)	Job Name: ms1.cnc																			
X	+0.0000	Tool: T8 H---																			
Y	+0.0000	Feedrate: 111% 0.0 ipm																			
Z	+10.0000	Spindle: 0 A																			
<div style="display: flex; justify-content: space-between;"> <div style="text-align: center;">  </div> <div style="text-align: right;"> <p>Wall Following Digitizing Stall detection disabled</p> <table style="width: 100%; border-collapse: collapse;"> <tr><td>Probe Tool Number</td><td style="text-align: right;">101</td></tr> <tr><td>Z Patch Distance</td><td style="text-align: right;">-0.1000</td></tr> <tr><td>Z Step</td><td style="text-align: right;">0.0500</td></tr> <tr><td>Stepover</td><td style="text-align: right;">0.0600</td></tr> <tr><td>Digitize File Name</td><td style="text-align: right;">wall_dig_file</td></tr> <tr><td>Approach</td><td style="text-align: right;">X+</td></tr> <tr><td>Inside/Outside</td><td style="text-align: right;">Outside</td></tr> <tr><td>Cut Feedrate</td><td style="text-align: right;">20.0000</td></tr> <tr><td>Cut Direction</td><td style="text-align: right;">Counter Clockwise</td></tr> </table> <ol style="list-style-type: none"> 1) Jog probe to start location 2) Enter parameters 3) Press Cycle Start to start probing </div> </div>				Probe Tool Number	101	Z Patch Distance	-0.1000	Z Step	0.0500	Stepover	0.0600	Digitize File Name	wall_dig_file	Approach	X+	Inside/Outside	Outside	Cut Feedrate	20.0000	Cut Direction	Counter Clockwise
Probe Tool Number	101																				
Z Patch Distance	-0.1000																				
Z Step	0.0500																				
Stepover	0.0600																				
Digitize File Name	wall_dig_file																				
Approach	X+																				
Inside/Outside	Outside																				
Cut Feedrate	20.0000																				
Cut Direction	Counter Clockwise																				

Setting up a Wall Following Digitizing Run

To set up a digitize run, edit the parameters shown. Jog the probe tip to the XY starting location (inside or outside of the part to be digitized), and then jog Z to the level of the first digitize pass. Press **CYCLE START** to start the digitize run.

Wall Following Digitizing Parameters

Probe Tool Number: The tool number of the probe.

Z Patch Distance: The total Z distance to digitize, incremental from the first pass. Entering a negative value will cause the routine to step down in the Z. Entering a positive value will cause the routine to step up in the Z.

Z Step: The Z amount to step down per pass.

Stepover: The distance between the digitized points.

Digitize File Name: The base name of the output file in which the digitize data is stored. An extension of *.dig* will automatically be appended to the name for replay as a CNC job.

Approach: The direction of the first digitizing move.

Inside/Outside: Starting location of the probe; inside the part or outside.

Cut Feedrate: The replay feedrate. This is the feedrate that will be output to the file specified by the Digitize File Name above. This will cause the digitized data to be replayed at this specified feedrate when the output data is run as a CNC job.

Cut Direction: The Clockwise or Counter Clockwise direction of the output data. This also defines the direction of digitize.

Wall Following Digitizing Notes

The output data is uncompensated. Therefore the resultant output data points will be offset by the probe tip's radius amount. If you want to run this data as a CNC job and actually do cutting, you must use a cutter that is the same shape and diameter as the probe tip. An alternative to this is to use a CAD/CAM software package to remove the probe tip offset and to apply the desired compensation.

Dig to CAD (F6 from Digitize Menu)

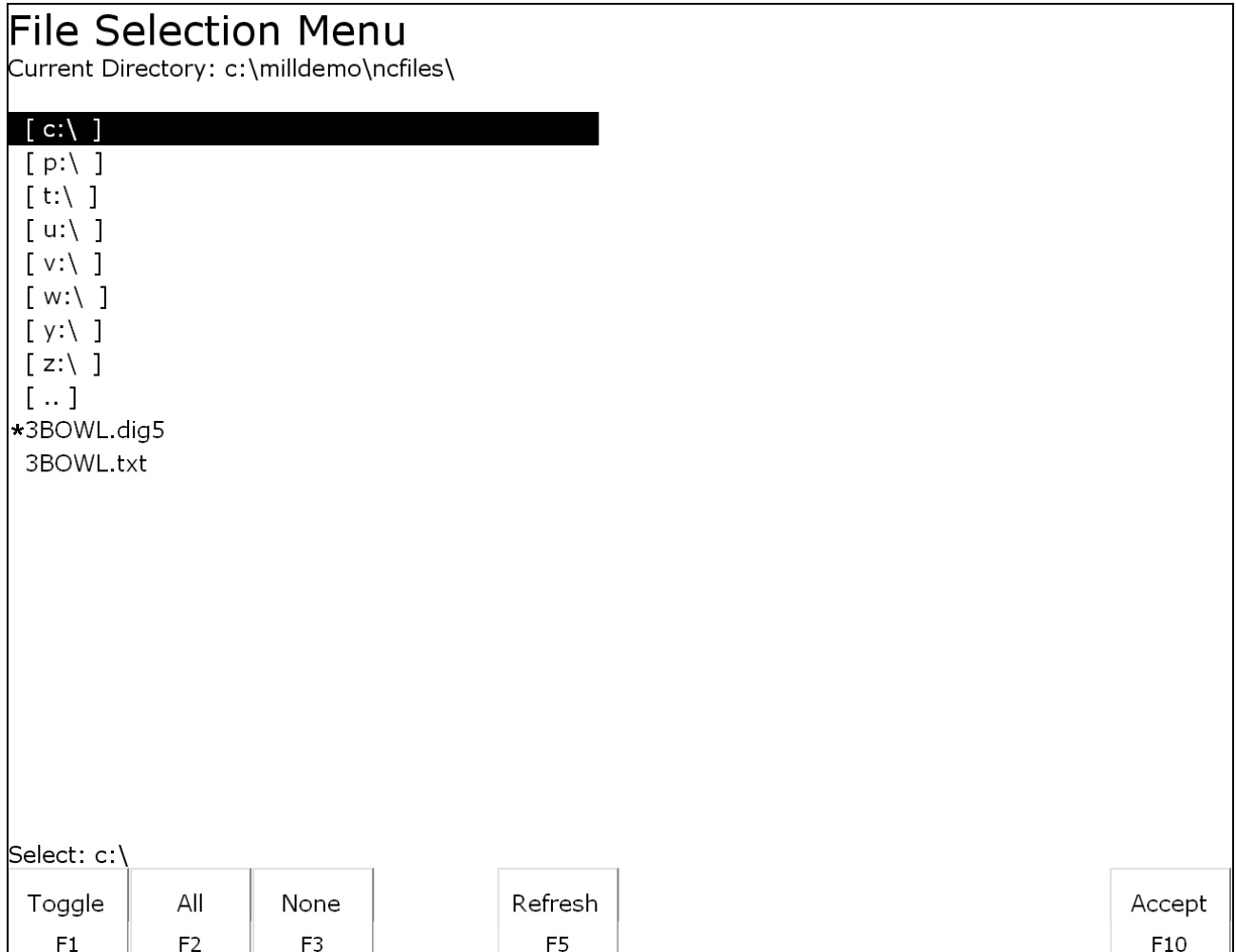

The Dig to CAD feature of the CNC software is used to export digitized files for use with CAD/CAM software. The digitized files are converted to point cloud data that is easily readable by most CAD/CAM systems. Digitized files have either a .DIG or .DIG5 extension. Files with the extension .DIG are created from the grid or wall following digitizing routines, while .DIG5 files are created from 5-axis digitizing toolpaths. The resulting point cloud data files will have the same file name as the .DIG and .DIG5 files they were created from, only they will have a .TXT extension. These files can then be imported into any CAD/CAM software or viewed with a simple text editor.

In the case of 5-axis CNC controls, where the 4th and 5th axes are rotary axes, parameters 116-119 are used in conjunction with Dig to CAD to properly position the collected data (see Chapter 14 for more information on these parameters).

Chapter 9

Probing

Attention!! Refer to the Probe Parameters sections at the end of this chapter before using any probe.

Part Setup with Probing

Single axis, single surface probing is available on the Set Part 0/Position screen using the **F4 - Auto** key. This allows you to probe various surfaces to define the part coordinate system. Multi-axis and multi-surface probing cycles are available on a separate screen, accessible from Set Part 0/Position with the **F5 - Probe** key or from **F4 - Probe** in the digitize screen. These allow you to locate the center points and corners of differently shaped parts.

Brushless motor note: If you experience excessive vibration on a brushless drive system, use Parameter 10 to select smooth deceleration in probing moves. See Chapter 14 for more information.

WCS #1 (G54) Current Position (Inches) Job Name: flange.cnc
 X +6.2140 Tool: T1 H---
 Y +0.0000 Feedrate: 100%
 Z +0.0000 Spindle: 0 M Coolant

Set Part 0/Position

1) Select Axis with F1
 2) Jog to Touch Off on Part
 3) Edit the Value if Necessary
 4) Press F10 to Set Position

Axis	Part Position	Edge Finder Diameter	Approach From
X	0.0000	0.0000	Left (-)

Press SPACE to change

Next Axis F1 Auto F4 Probe F5 Prev WCS F6 Next WCS F7 CSR F8 WCS Table F9 Set F10

WARNING: Before manually jogging any probe, make sure the machine Feedrate is slow (less than 10 in/min) or damage to the probe may result!

Automatically Setting Part 0

Part zero can be found using the probe. Make sure your probe height and diameter offsets are set for the tool number you assigned to the probe and that parameter 12 is set to that tool number. The Edge Finder Diameter will be set automatically.

To set part 0 using the probe:

1. Select the current work coordinate system by pressing **F6 – Prev WCS** or **F7 – Next WCS**. Then select the axis you want to probe by pressing **F1 – Next Axis**.
2. Manually jog the probe about 1/2 inches away from the surface you wish to define. Make sure the approach direction to the part is set properly. Probe the selected axis by pressing **F4 - Auto**. When the surface is found, the control will assume this point to be the new axis 0.

3. If you want this probed surface to be something different than 0, enter the value by the using arrow keys to highlight Part Position, and then type in the value and press **F10 - Set**.

Repeat steps 1-3 to set the remaining axes using the probe. Any previously entered Edge Finder Diameter or Tool Number value will be discarded.

Finding Center/Corner Points

To enter the Probing Cycles screen, press **F5 - Probe** from the Set Part 0/Position screen. You can locate the center of a bore, boss, slot, or web. You can also find an inside corner, outside corner, or a single axis. The corner points don't even have to be right angles! The Edge Finder Diameter doesn't need to be entered since these cycles place the probe directly over the center or corner of the part.

Calibrating the Probe Tip Diameter

You can calibrate the probe tip diameter to compensate for pre-travel (the amount that the probe deflects before it actually trips). Simply enter a probe tip diameter of zero, probe out a precision bore with a known diameter, and enter the difference between the reported bore diameter and the found bore diameter as the actual probe tip diameter.

Probing Cycles

You can enter the Probing Cycles screen from either the Set Part 0/Position screen (**F5 - Probe**) or the Digitize menu (**F4 - Probe**). The Probing Cycles screen is shown below:

WCS #1 (G54) Current Position (Inches) Job Name: 2axtst05.cnc
 X -1.0000 Tool: T3 H...
 Y +1.0000 Feedrate: 100%
 Z +1.0000 Spindle: 0 A

302 Moving...
 305 Processing...
 302 Moving...
 305 Processing...
 306 Job finished
 301 Stopped

Probing Cycles

Probe diameter (Tool #10): 0.0000

Bore	Boss	Slot	Web	In Corner	Out Corner	1 Axis	Angle
F1	F2	F3	F4	F5	F6	F7	F8

The probing cycles will report the location and dimensions, as applicable, of the probed feature in a floating dialog box. The dimensions are adjusted to compensate for the probe tip diameter, entered in the Offset Library (see Parameter 12). For your convenience, you can edit the probe diameter on this screen, as long as the Tool Number, as set in Parameter 12, is not 0. During the probing cycles, the probe will move at speeds specified in Parameters 14 and 15. Refer to the Probe Parameters section later in this chapter for more information.

F1 – Bore Press **F1 - Bore** to enter the Bore screen. A picture similar to the one shown at right will appear, with instructions. Follow these steps:

- 1 - Make sure the probe is clear of any obstacles.
- 2 - Manually jog the probe inside the hole. The probe tip should be just below the top edge of the surface.
- 3 - Press **CYCLE START** to start the probing.

At the end of probing, the probe will be positioned at the center of the bore, and the X and Y positions will be shown on the screen.

Press **ESC** to return to the Set Part 0/Position screen or digitize screen.

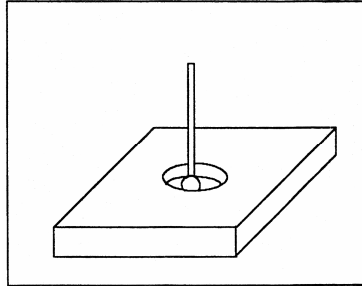

F2 – Boss Press **F2 - Boss** to enter the Boss screen. A picture similar to the following will appear, with instructions and two input fields. Follow these steps:

- 1 - Press **F1 - Orient** to select the orientation of the probe with respect to the Boss. You will see one of the screens shown below.
- 2 - Slowly jog the probe to the approximate orientation as shown in the picture. Be sure to give enough space for the probe tip to clear any obstacles during the jog.
- 3 - Enter the approximate Boss diameter.
- 4 - Highlight the Z clearance amount by pressing the down arrow key. Enter approximate distance (in the Z direction) the probe must move to lift up over the Boss.
- 5 - Press **CYCLE START** to start the probing cycle.

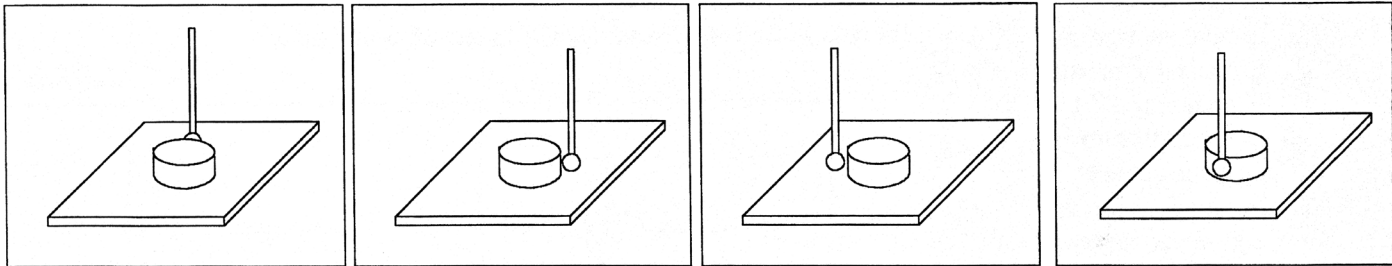

If the Z clearance you entered is too small, the probe will stop and show an error message. Correct the problem by repeating the previous steps. If the approximate diameter you entered is too small, the probe will bounce by 10 percent of its diameter across the top surface until it either finds the correct edge, the additional distance searched is equal to Parameter 16, or a travel limit is reached.

Once the probing cycle is complete, the probe will be positioned at the center of the boss at the Z clearance level entered. Press **ESC** to return to the Set Part 0/ Position screen or digitize screen.

F3 – Slot Press **F3 - Slot** to enter the Slot screen. A picture similar to the ones shown will appear along with instructions:

- 1 - Press **F1 - Orient** to select the orientation of the probe with respect to the slot.
- 2 - Slowly jog the probe to the approximate position shown in the picture. During this jog, make sure you have enough space between the probe and the part.
- 3 - Press **CYCLE START** to begin probing.

Once the cycle is finished, the probe will be located at the center of the slot. Press **ESC** to return to the Set Part 0 – Position Screen or digitize screen.

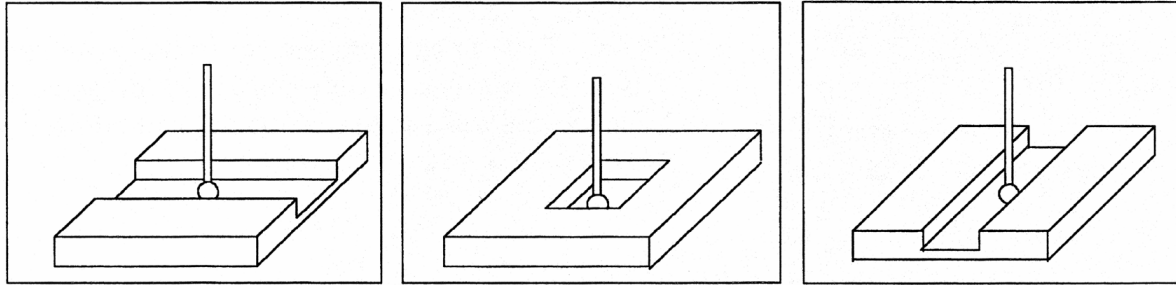

F4 – Web Press **F4 - Web** to enter the Web screen. A picture similar to the following will appear, with instructions and two input fields. Follow these steps:

- 1 - Press **F1 - Orient** to select the orientation of the probe. You will see one of the screens shown below.
- 2 - Slowly jog the probe to the approximate position shown in the picture. During this jog, be sure to give enough space between the probe and the part.
- 3 - Enter the approximate Web width.
- 4 - Highlight the Z clearance value using the up or down arrow key. Enter approximate distance the probe has to travel in order to lift up over the Web.
- 5 - Press **CYCLE START** to start the probing cycle. Once the probe has completed its search, it will automatically position to the centerline of the web.

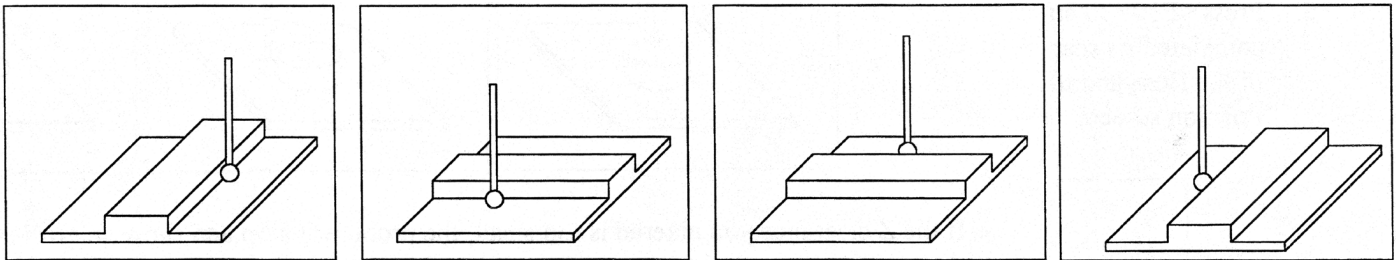

If the Z clearance you entered is too small, the probe will stop and show an error message. Correct the problem by repeating the previous steps. If the approximate width you entered is too small, the probe will bounce by 10 percent of its width across the top surface until it either finds the correct edge, the additional distance searched is equal to Parameter 16, or a travel limit is reached.

Once the probing cycle is complete, the probe will be positioned at the center of the web, at the Z clearance level entered. Press **ESC** to return to the Set Part 0/ Position screen or digitize screen.

F5 - In Corner (Inside Corner) Press **F5 - In Corner** to enter the Inside Corner screen. One of the pictures will appear with instructions. This cycle is similar to that of a slot cycle; the main difference is that you need to enter a clearance amount.

- 1 - Press **F1 Orient** and the screen will cycle through one of the probe orientations shown here.
- 2 - Enter the clearance Amount. This is an approximate distance (in the Z direction) the probe must move to clear the corner
- 3 - If the corner is rounded, jog the probe far enough away for it to miss the curved area during the probing cycle (at least twice the corner radius).
- 4 - Press **CYCLE START** to start the probing cycle.

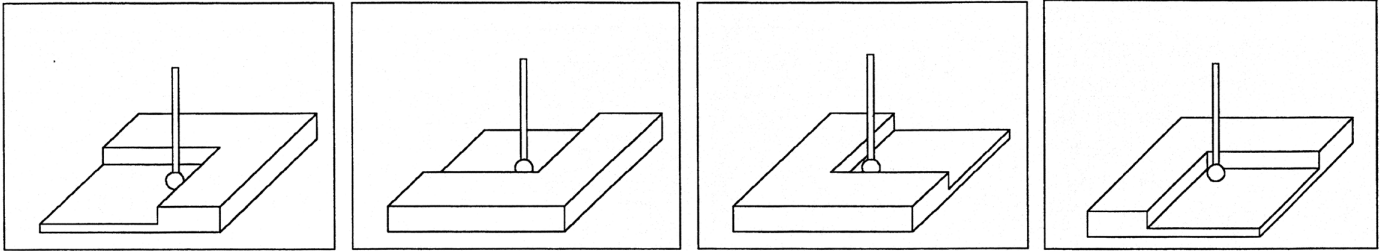

At the end of the probing cycle, the probe will be positioned above the corner at the Z clearance level entered. Press **ESC** to return to the Set Part 0/ Position screen or digitize screen.

F6 - Out Corner (Outside Corner) Press **F6 - Out Corner** to enter the Outside Corner screen. A picture similar to the following will appear, with instructions and two input fields.

Follow these steps:

- 1 - Press **F1 - Orient** to select the orientation of the probe with respect to the Corner. You will see one of the pictures shown.
- 2 - Press **F2 - Side** to select which side of the corner the probe will be positioned near. You will see the screen change.
- 3 - Slowly jog the probe to the approximate position as shown in the picture. Be sure to give enough probe clearance.
- 4 - Select the Z clearance field using the arrow keys. Enter the approximate distance the probe has to travel in order to lift up over the corner.
- 5 - Select the Distance to Corner amount using the up or down arrow keys. Enter the approximate distance from the corner the probe is along the X or Y axis.
- 6 - Press **CYCLE START** to start the probing cycle.

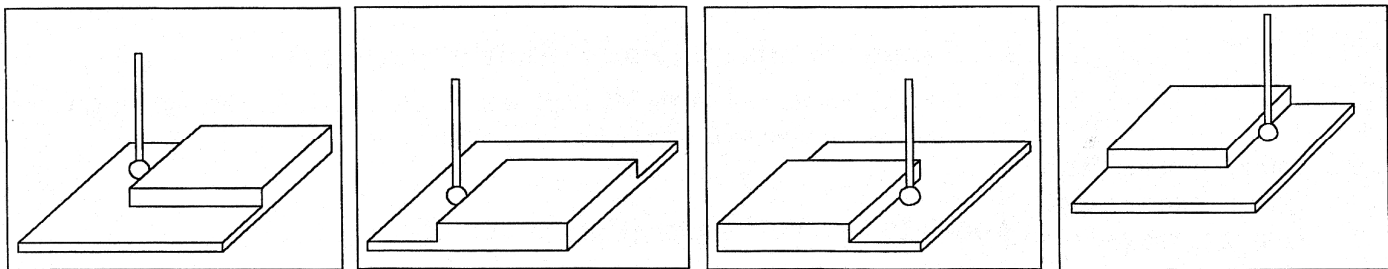

Once the probe has completed its search, it will be positioned above the corner at the Z clearance you specified. Press **ESC** to return to the Set Part 0/ Position screen or digitize screen.

F7 - 1 Axis (Single Axis) Press **F7 - 1 Axis** to enter the Single Axis screen. Follow these steps:

- 1 - Press **F1 - Orient** to select the orientation of the probe. You will see one of the screens shown below.
- 2 - Slowly jog the probe to the approximate position as shown in the picture. Be sure to give enough probe clearance.
- 3 - Press **CYCLE START** to start the probing cycle.

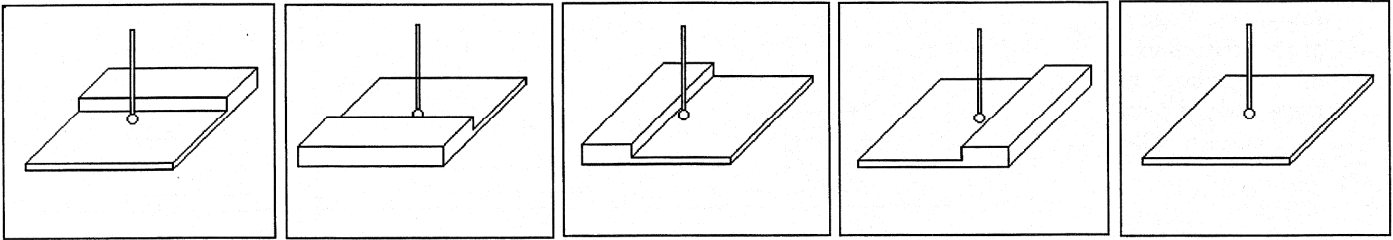

Once the probing cycle is complete, the probe will move away from the surface by the amount in Parameter 13. The probed position will be shown on screen. Press **ESC** to return to the Set Part 0/ Position screen or digitize screen.

F8 – Angle – Use this feature to measure an angle from based on 2 probed points.

Follow these steps:

- 1 - Press **F1 - Orient** to select how the angle is to be measured.
- 2 - Slowly jog the probe to the first position as shown in the picture. Be sure to give enough probe clearance.
- 3 - Select Auto or Jog between points.
- 4 - Enter the distance to second point.
- 5 - Enter a clearance amount away from the surface.
- 6 - Press **CYCLE START** to start the probing cycle.

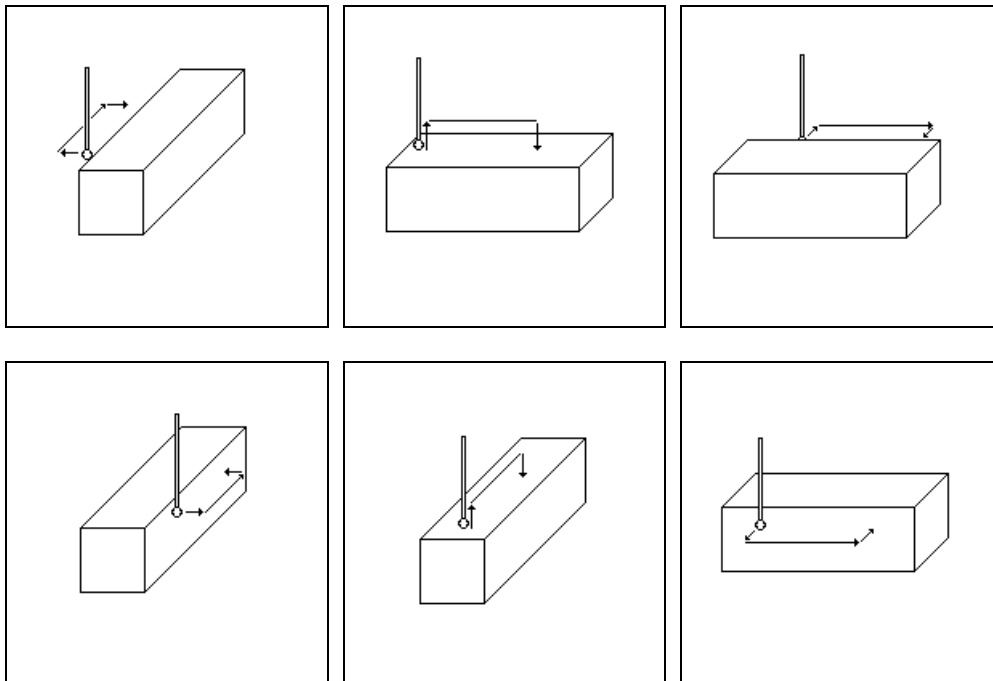

Probe / TT-1 Parameters

Various probing parameters can be set on the Machine Parameters screen (see Chapter 14). Make sure you enter these parameters before you begin using the probe and/or TT-1. If these parameters are not entered properly, damage to the probe or TT-1 may result.

Probe Type (Parameter 155) – This specifies the probe type being used. This needs to be set to 0 if you are using a standard Mechanical probe.

Probe PLC Input Number and Contact State (Parameter 11) - A single value, +/-1 through 240. A positive number indicates Closed on contact; a negative number indicates Open on contact.

TT1 PLC input number (Parameter 44) - This parameter is the input number that the TT1 is wired into on the PLC. If a shared PLC input is used for both the TT1 and the probe, then the value can be left at zero or set to the same value as parameter 11.

Probe Tool Number (Parameter 12) - A single value, 0 through 200, used to look up the length offset and tip diameter of the probe in the Offset Library.

Recovery Distance* (Parameter 13) – The additional distance the probe moves off of a surface after contact is broken, before attempting to traverse parallel to the surface.

Fast Probing Rate* (Parameter 14) - Used for positioning moves and initial surface detection, this parameter is determined by machine response and permitted probe deflection as well as desired tolerance. The default setting is 25 inches/min.

Slow Probing Rate* (Parameter 15) - Used for final measuring moves, this parameter is determined by a speed/accuracy tradeoff. The default setting is 3.5 inches/min.

Maximum Probing Distance (Parameter 16) - The maximum distance that a probing cycle "searches" for a surface in a given direction if no travel limits have been entered. The default is 10 inches. A larger value should be entered for the hole and slot cycles if you are measuring very large features.

Detector Location Return Point (Parameter 17) - A Zero (0) indicates that tool measurement will take place at the current position, a 1 or 2 indicates the number of the G30 reference point to use which specifies the X, Y location of the TT1 (WCS Configuration).

*Mechanical type probe only. Please see the DSP type probe section below for differences.

DSP Probe Parameters

When using a DSP type probe (such as DP-4D), a few of the probing parameters have a slightly different behavior than described above. These differences are noted below:

Probe Type (Parameter 155) – This specifies the probe type being used. This needs to be set to **1** for a **DP-4D** probe or set to **2** for a **DP-7** probe.

Repeatability tolerance for probing and radial digitizing (Parameter 151) – used for DP-4 probes. Must be set to 0 for DSP probes.

Grid digitize prediction minimum Z pullback (Parameter 121) – set to 0.035 for DSP use.

Recovery Distance (Parameter 13) – Works as described above but additionally it used as the distance to retract for a retry after a failed window (does not apply to M115/116/125/126 moves) (Default for DSP is 0.05). Note: If probing small bores this parameter may need to be reduced accordingly.

Fast Probing Rate (Parameter 14) – When using a DSP type probe, this is actually the rate at which the probe will move “in-between” actual probing moves. For instance, if you were probing a boss, this is the rate at which the probe will travel for the following moves:

1. When retracting from the surface after a point has been probed.
2. When retracting to the Z clearance position.
3. Rate at which it will traverse across the diameter of the boss at the Z clearance height.
4. Plunge rate to get to probing depth.

Note: When measuring a TOOL with the TT1, the behavior is identical to that listed above.

Slow Probing Rate (Parameter 15) – Used only when measuring a TOOL with the TT-1.

Additional Probe Parameters for DP-7

For the DP-7 probe (parameter 155 = 2), the following additional parameters are utilized:

DP-7 Pullback Distance (Parameter 392) – This sets the distance the probe moves off from the surface after a probing move.

DP-7 Pullback Feedrate (Parameter 393) – This sets the feedrate for the pullback move.

DP-7 Measuring Feedrate (Parameter 394) – This sets the feedrate for the slow measuring move.

Chapter 10

Intercon Software

Introduction

Intercon (Interactive Conversational) software allows you to quickly create a part program right at the control without having to be a G-code expert. Intercon will prompt you to enter values from your print that describes the geometry of the part. Intercon will display graphics of the part as you are creating it, helping you quickly proceed through part programming. Intercon can then generate a G-code program from the geometric information you have entered.

You can purchase an offline version of the Intercon software for use on your desktop PC. You will need to purchase a hardware key, which will allow the offline version to run. Simply plug the key into the computer, install the required drivers, and run it.

Intercon Main Screen

When you access Intercon through the **F5 - CAM** option in the CNC software Main screen, the part program will be displayed if the current job loaded in CNC software had an associated Intercon program. If the job file in the CNC software did not have an associated Intercon program, the **F1 - File** menu will be displayed to load or create a file.

Intercon Mill					Current Part: Flange.icn				
Operation #	Type	X	End Y	Z					
0001	;Motor Flange								
0002	Tool #1	0.0000	0.0000	Home					
0003	Circ Poc	0.0000	0.0000	0.1000					
0004	Drill BHC	1.0607	1.6070	0.1000					
0005	Frame	3.2500	4.1250	0.1000					
0006	End Prog	3.2500	4.1250	Home					
					Status				
File F1	Modify F2	Insert F3	Cut F4	Paste F5	Copy F6	Copy Menus.. F7	Graph F8	Setup F9	Post F10

When the part program is displayed, different operations can be navigated and highlighted for additional actions by using the arrow keys, and the **HOME**, **END**, **PAGE UP** and **PAGE DOWN** keys.

File Menu (Intercon Main Screen ► F1 – File)

F1 – File Choosing **F1 - File** will display the screen below. Intercon stores part programs with an extension of .icn. For example, if you choose to name your new part program flange, Intercon will save the program as flange.icn. ICN files are only readable by Intercon.

Intercon Mill		Intercon File Menu		Current Part: Flange.icn	
Directory: c:\intercon					
File	Programmer	Description	Date Modified		
[a:\]		Drive			
[c:\]		Drive			
[d:\]		Drive			
[j:\]	Sandisk	Drive			
[.]		Parent directory			
flange	John Q. Public	Demo Flange Part	06-Oct-2006		
helix	John Q. Public	Demo Helix Part	06-Oct-2006		
irreg	John Q. Public	Demo Pocket Cleanout	06-Oct-2006		
linecrl	-	-	19-Nov-2006		
thread	John Q. Public	Demo Thread	06-Oct-2006		
__oscp__	One Shot Circ Pocket	* DO NOT MODIFY *	06-Oct-2006		
__osda__	One Shot Drill Array	* DO NOT MODIFY *	06-Oct-2006		
__osdb__	One Shot Drill BHC	* DO NOT MODIFY *	06-Oct-2006		
__osdr__	One Shot Drill Cycle	* DO NOT MODIFY *	06-Oct-2006		
__osfa__	One Shot Face	* DO NOT MODIFY *	06-Oct-2006		
__osfr__	One Shot Frame	* DO NOT MODIFY *	06-Oct-2006		
__osrp__	One Shot Rect Pocket	* DO NOT MODIFY *	06-Oct-2006		
New F1	Load F2	Save F3	Save As F4	Delete F5	Details On/Off F9

F1 – File ► F1 – New To program a new part, choose **F1 – New**. A prompt will be displayed where the name of the new program can be typed, followed by the **F10 - Accept** or **ENTER** key to accept the new name can be entered. You can enter who the programmer is, a program description, the units of measure and the date.

Load Menu (Intercon Main Screen ► F1 – File ► F2 – Load)

F1 – File ► F2 – Load When you press **F2 - Load**, the screen below is displayed. (Shown with details “ON”)

Load file from CNC hard drive c:\intercon									
Use arrow keys to select file to load and press F10 to Accept.									
File	Programmer	Description	Date Modified						
[.]		Parent directory	06-Oct-2006						
flange	John Q. Public	Demo Flange Part	06-Oct-2006						
helix	John Q. Public	Demo Helix Part	06-Oct-2006						
irreg	John Q. Public	Demo Pocket Cleanout	19-Nov-2006						
thread	One Shot Circ Pocket	Demo Thread	06-Oct-2006						
__oscp__	One Shot Drill Array	* DO NOT MODIFY *	06-Oct-2006						
__osda__	One Shot Drill BHC	* DO NOT MODIFY *	06-Oct-2006						
__osdb__	One Shot Drill Cycle	* DO NOT MODIFY *	06-Oct-2006						
Job to load? bracket.cnc									
G code /ICN F1	Floppy /USB/LAN F2	Details On/Off F3	Show Recent F4	Date/ Alpha F5	Edit F6	Help On/Off F7	Graph F8	Advanced F9	Accept F10

To navigate the files in the load menu, use the arrow keys to move the cursor around and highlight the file to be loaded. The **HOME**, **END**, **PAGE UP** and **PAGE DOWN** keys can be used to navigate the list of files. Names that are bracketed, for example [..], are the names of directories in the current directory, which is displayed at the top of the screen.

It is also possible to start typing the name of the program to be loaded. When typing has started, the characters appear in the “File to load:” prompt above the function keys. Different drives and directories can be accessed by typing in the path at the “File to load:” prompt, or by pressing **F10** or **ENTER** on a bracketed directory name. When loading a new file, a prompt will be displayed asking whether to save the existing file if there was one.

Additional Load Menu options are detailed below:

F1 – G code/ICN Allows user to toggle the view between the Intercon files present in either c:\intercon or c:\cnm\ncfiles.

F2 – Floppy USB/LAN Provides options for loading Intercon files from USB devices, floppy and LAN drives.

F3 – Details On/Off The **F3-Details On/Off** option changes the format of the display such that each file or directory is on a separate line and there are columns displayed for Programmer, Description, and Date Modified, i.e., the information that is contained in the program header operation.

F4 – Show recent Use the **F4-Show Recent** option to show the 15 most recently loaded Intercon and g-code files. It is important to remember that even though g-code files are displayed on this screen, **ONLY** Intercon files should be loaded from this screen. **WARNING!!!** Attempting to load a g-code file from the “Show Recent” screen will cause an error which will discard the current Intercon program. All unsaved changes will be lost. If you should accidentally load a g-code file, press escape to return to the main Intercon menu.

F5 – Date/Alpha Use **F5-Date/Alpha** to view files either alphabetically or by date modified. By default, programs are listed in ascending alphabetical order.

F6 – Edit Opens the selected file in Intercon for editing.

F7 – Help On/Off Displays on screen help for the load menus.

F8 – Graph Graphs the selected file.

F9 – Advanced Displays file menu in a comprehensive “all in one” format similar to Windows Explorer

File Menu (Intercon Main Screen ► F1 – File, continued from pg 10-2)

F1 – File ► F3 – Save Press **F3 - Save** to save the current part program. The current program will be saved under the specified name.

F1 – File ► F4 - Save As Press **F4 – Save As** to save the current program with a different name. Type the new name into the “**Save part as:**” prompt that appears above the function keys. If the new name already exists, a prompt will be displayed as a warning and will give the option to overwrite the existing file or return to enter a different name.

F1 – File ► F5 – Delete Press **F5 - Delete** to delete a file. After **F5 - Delete** is pressed, the screen will appear as in the **F2 - Load** option where you can be to navigate the files. A yes/no prompt will appear after accepting a file for deletion for final confirmation.

F1 – File ► F9 - Details on/off The **F9 - Details On/Off** changes the format of the display such that each file or directory is on a separate line and there are columns displayed for Programmer, Description, and Date Modified, i.e., the information that is contained in the program header operation.

Intercon Main Screen (continued from pg 10-1)

F2 – Modify Choosing F2 - Modify from the Intercon main menu will allow the currently highlighted operation to be modified. When an operation is modified, the fields for that operation are displayed on the right hand side. When modifying an operation, the PAGE UP and PAGE DOWN keys can be used to move up and down through the Intercon operations listed on the left hand side of the screen.

F3 – Insert Choosing F3 - Insert will insert a new operation before the operation that is currently highlighted, unless the highlighted operation is the first operation in which case the inserted operation will be inserted as the second operation. For more information on the operations see Insert Operations later in this chapter.

F4 – Cut Choosing F4 - Cut will cut (remove) the highlighted operation from the program. The operation that is cut is placed onto the clipboard stack.

F5 – Paste Choosing F5-Paste will paste the last operation that was cut or copied into the clipboard stack into the current program line that is before the highlighted operation. The number of operations that are currently in the clipboard stack are indicated by the number in the Paste key. As long as you stay in Intercon, the clipboard stack will remain intact. You may cut and copy operations from one program and paste them into a different program.

F6 – Copy Choosing F6 - Copy will copy the highlighted operation into the clipboard stack and advance the cursor to the next operation.

F7 – Copy Menus... Choosing F7 - Copy Menus... will display these additional options:

F1 - Copy Menu Allows a range of operations to be copied. Specify the Start Block, End Block, and Destination in the prompts that appear in the Copy Menu. The range of operations is copied into a location that precedes the destination block.

F2 - Move Menu Allows a range of operations to be moved. Specify the Start Block, End Block, and Destination in the prompts that appear in the Move Menu. The range of operations is moved into a location that precedes the destination block.

F9 - Clear Clipbrd Removes all operations in the clipboard stack.

F8 – Graph Choosing F8 - Graph will graph the current program. The graph is the same as what would be produced if the current program were translated into G-codes and graphed from the CNC software. Canned drilling cycles are shown in gray. Rapid traverse movements are shown in red. Feedrate movements are shown in yellow and cutter compensated moves are in gray.

F9 – Setup Choosing F9 - Setup will display the Setup menu where certain options can be set. The Setup menu appears as below.

Intercon Setup	
Comment Generation	: Enabled
Clearance Amount	: 0.1000
Spindle/Coolant Delay	: 0.20
Corner Feedrate Override	: 50.00%
Modal Linear	: No
Modal Arc	: No
Modal Drill/Bore/Tap	: No
Rotary 4th Axis	: No
DRO Units	: Inches
Machine Units	: Inches
Help Icons always on	: No
Cutter Comp Look-ahead	: 3

Use the up and down arrow keys to move. Clearance Amount, Spindle/Coolant Delay, and Corner Feedrate Override require a value to be typed in. The other fields have fixed values that may be toggled by using the **F1 - Toggle** key.

Comment Generation: When this field is set to Enabled, Intercon will put a comment describing the operation type before each block. Disabling Comment Generation will make the CNC files generated by Intercon smaller.

Clearance Amount: This is the distance that Intercon raises the Z-axis above the programmed surface height in pockets, facing and frame mills when traveling across the work piece.

Spindle/Coolant Delay: Set this delay to the time in seconds you want Intercon to wait for the spindle to get up to speed and the coolant to begin flowing.

Corner Feedrate Override: This is the percent feedrate that will be used in the corners of rectangular pockets and inside frame mills. The default value is 50%.

Modal Operations: These options specify whether to automatically insert the same operation after the first has been accepted. Once modal insert mode has begun, press **ESC** to insert a different operation.

Rotary 4th Axis: This option specifies whether or not 4th axis movement fields appear in Linear and Rapid moves and whether or not the Intercon program will post 4th axis movement. This option affects the value in the 4th axis configuration only (parameter 94). Note that although Intercon is restricted to working with 1 rotary axis at a time, it can be directed to utilize the 5th axis as its rotary axis instead of the 4th. To make Intercon to utilize the 5th axis as its rotary axis instead of the 4th axis, the 4th axis configuration (parameter 94) must have its rotary property turned off (bit 0 = 0) and the 5th axis configuration (parameter 166) must have its rotary property turned on (bit 0 = 1). See chapter 14 for details about parameters 94 and 166.

DRO Units: Specifies the Units used for the DRO. It affects the corresponding field in the Control Configuration.

Machine Units: Specifies the Units used for machining. It affects the corresponding field in the Control Configuration of the CNC software. The posted G-code will contain a G20 for Inches mode and a G21 for Metric mode.

Help Icons always on: Toggle between yes or no. Selecting “yes” means that help information will always be displayed when editing operations. “No” means that you will have to press a key to get help. Whether set to “yes” or “no”, the help screens can always be toggled on or off by pressing the **F5 - Help** key when editing an operation.

Cutter Comp Look-ahead: This sets the number of segments that can be parsed ahead when Cutter Comp is turned on.

F10 – Post Choosing F10 - Post will post the current program. Posting is the process of converting the operations into G-codes. When the posting process is completed, Intercon is exited. The Intercon program is also saved as part of the posting.

Insert Operation (Intercon Main Screen ► F3 – Insert)

When you press **F3 - Insert**, or when you choose New Part from the Main Screen, you will see the Insert screen:

Intercon Mill v1.25		Current Part: E_Z_PART.icn		
Operation #	Type	X	End Y	Z
0001	;Demo Program			
0002	End Prog	0.0000	0.0000	Home

Select operation to insert...

Rapid F1	Linear F2	Arc F3	Tool F4	Cycles ... F5	Other ... F6	Cutter Comp F7	Subpgm ... F9
-------------	--------------	-----------	------------	---------------------	--------------------	----------------------	---------------------

The new operation will be inserted right before the currently highlighted one. The operation types that you can insert are listed across the bottom of the screen.

F1 - Rapid Traverse Press F1 - Rapid from the Insert Operation screen to insert a Rapid Traverse. You may see the following screen:

Intercon Mill v1.25				Current Part: E_Z_PART.icn	
Operation #	Type	X	End Y	Z	N0002 Rapid Traverse
0001	; Demo Program				End X: 0.0000
0002	Rapid				Y: -5.0000
0003	End Prog	0.0000	0.0000	Home	Z: 0.1000
					Angle : 270.0000°
					Length : 5.0000

Abs Inc F1	Z Home F2	Help F5	Math Help F6	Graph F8	Teach Mode F9	Accept F10
---------------	--------------	------------	-----------------	-------------	------------------	---------------

End: When you first access the rapid traverse screen, the cursor will be highlighting the first field, End X. This is the X coordinate of where the cutter will be after the rapid traverse has been completed. Similarly, Y and Z represent the coordinates of the cutter after the rapid traverse is completed. The angle and length fields will be computed if you choose to enter the end point of the move.

Angle: The destination may also be specified in terms of a counterclockwise angle from the three o'clock position. When combined with a length for the current move, the corresponding X and Y coordinates for the destination will be calculated and placed in the correct fields. The Z destination will remain unchanged, however.

Length: The length of the rapid traversal. When combined with the angle of the current move, the corresponding X and Y coordinates for the destination will be calculated and placed in the correct fields. The Z destination will remain unchanged, however.

The **F1 – Abs/Inc** key toggles between incremental and absolute positioning modes in any of the fields where a positional dimension is needed. For example: X, Y, or Z-axis dimensions can all be in incremental or absolute coordinates, or a mixture of both. The length and angle fields cannot be incremental. These fields are absolute values.

The **F2 - Z Home** key may be used on the Z destination field to tie the ending Z coordinate to the Z home position. This means that no matter what you're Z home value is at the time that you run your program, the final Z position will be the Z home position.

When you are finished entering all of the dimensions for the rapid move, press **F10 - Accept** to accept the operation and return to the Insert Operation screen.

NOTE: When making rapid moves, if a Z destination higher than the current cutter position is specified, the cutter will first be raised to the destination Z position, and then move linearly in X and Y to arrive at the destination. If a Z destination lower than the current cutter position is specified, the cutter will move linearly in X and Y first and then plunge Z to the destination Z position.

NOTE: The Rapid traverse operation can have rotary fields, if you have a rotary fourth axis. The rotary field descriptions are the same as that of the Linear Mill operation.

F2 - Linear Mill If you press F2 - Linear from the Insert Operation screen, the following screen appears:

Intercon Mill v1.25				Current Part: E_Z_PART.icn	
Operation #	Type	X	End Y	Z	N0006 Linear
0001	;Demo Program				End X: 7.0000
0002	Rapid	0.0000	-5.0000	0.1000	Y: 3.0000
0003	Tool #1	0.0000	0.0000	Home	Z: 1.0000
0004	Line	4.0000	0.0000	1.0000	Angle : 18.4349°
0005	Line	4.0000	2.0000	1.0000	Length : 3.1623
0006	Line				Connect Radius : 0.0000
0007	End Prog	4.0000	2.0000	Home	Feedrate : 12.0000

Toggle F3	Help F5	Math Help F6	Graph F8	Teach Mode F9	Accept F10
--------------	------------	-----------------	-------------	------------------	---------------

The numbers in the different fields on the screen correspond to the following Linear Mill example shown here graphically:

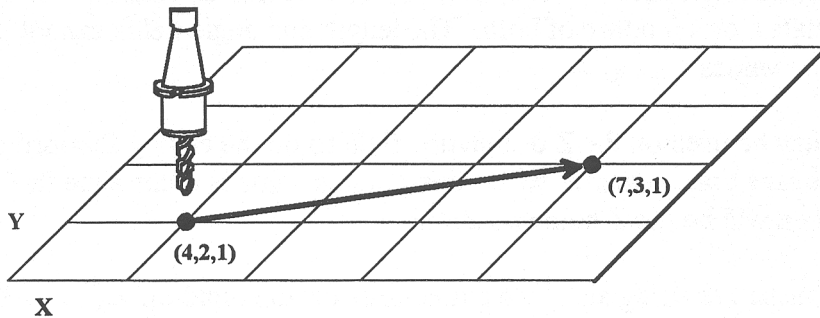

End: When you first access the linear mill screen, the cursor will be highlighting the first field, End X. This is the X coordinate of where the cutter will be after the linear move has been completed. Similarly, Y and Z represent the coordinates of the cutter after the linear move is completed. The angle and length fields will be computed if you choose to enter the end point of the move.

Angle: The destination may also be specified in terms of a counterclockwise angle from the three o'clock position. When combined with a length for the current move, the corresponding X and Y coordinates for the destination will be calculated and placed in the correct fields. The Z destination will remain unchanged, however.

Length: The length of the linear mill. When combined with the angle of the current move, the corresponding X and Y coordinates for the destination will be calculated and placed in the correct fields. The Z destination will remain unchanged, however.

Connect Radius: If you are performing two linear mill operations and you wish to have a rounded 'corner' between them instead of a sharp peak, you may enter the radius of the 'corner' and Intercon will insert an arc between the linear mill operations. This connect radius also works for blending a line into an arc operation.

Feedrate: Speed at which the cutter moves.

The feedrate can be toggled to modal, fixed, or slave. This is indicated by the symbol beside the feedrate field. If the feedrate is modal then it will have the “M” symbol or if it is fixed it will have the “F” symbol shown below. The slave feedrate has no symbol and is set to the last modal feedrate set in the program, when the modal feedrate changes all the following slave feedrates change until the next modal feedrate is encountered.



If you have a fourth axis installed and it is rotary, additional fields are shown for Linear Mill operations after the feedrate field.

Degrees: The number of degrees you want to move the rotary axis. This value can be positive or negative and the movement of the rotary axis will depend on the orientation of the axis.

Minutes: The number of minutes you want to move the rotary axis. Values for this field are between 0 and 59.

Seconds: The number of seconds you want to move the rotary axis. Values for this field are between 0 and 59.

Decimal degrees: This is another method of entering the number of degrees. If you choose to enter the movement of the rotary axis with the fields listed above, the value of this field will be calculated automatically. If you choose to enter the number of degrees with this field or make changes to it, then the degrees, minutes and seconds will be calculated or changed automatically. Values for this field can be positive or negative.

Rotary movement defaults to zero degrees, incremental. To enter an absolute (rather than incremental) rotary position, you must press **F1 - Abs/Inc** to toggle to absolute.

F3 - Arc Mill If you press F3 - Arc for Arc Mill from the Insert Operation screen, the following screen appears:

Intercon Mill v1.25					Current Part: E_Z_PART.icn	
Operation #	Type	X	End Y	Z	N0007 Arc	
0001	;Demo Program				Arc Type	: EP & R
0002	Rapid	0.0000	-5.0000	0.1000	Mid	X: 8.5000
0003	Tool #1	0.0000	0.0000	Home		Y: 4.5000
0004	Line	4.0000	0.0000	1.0000		Z: 1.0000
0005	Line	4.0000	2.0000	1.0000	End	X: 10.0000
0006	Line	7.0000	3.0000	1.0000		Y: 3.0000
0007	Arc CW					Z: 1.0000
0008	End Prog	7.0000	3.0000	Home	Center	X: 8.5000
						Y: 3.0000
						Z: 1.0000
					Angle	: 180.0000°
					Radius	: 1.5000
					Plane	: XY
					Direction	: CW
					Connect Radius	: 0.0000
					Feedrate	: 20.0000 M
					Angle <= 180	: Yes

Toggle F3	Help F5	Math Help F6	Graph F8	Teach Mode F9	Accept F10
--------------	------------	-----------------	-------------	------------------	---------------

The numbers in the different fields on the screen correspond to the following Arc Mill example shown here graphically:

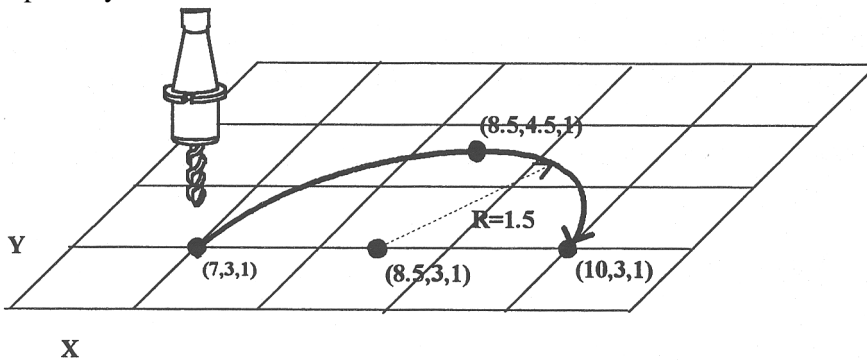

Operation Type: There are four ways to specify your ARC: using an endpoint and a radius (EP&R), using a center point and an angle (CP&A), using a center point and an end point (CP&EP), or using a mid-point and an end point (3-Point). The Three Point arc is designed to be used in conjunction with Teach Mode. When specifying a particular kind of arc, you will not be able to modify certain fields. For example, if you are specifying an endpoint and a radius, you will not be able to modify the mid point, center point and angle fields. This is because Intercon calculates the correct values for these fields.

Mid: The X, Y, and Z coordinates of a point on the arc path somewhere between the start point and end point of the arc. You will be able to modify this field only when specifying a Three Point arc. Also, the coordinate that does not lie in the plane of the arc cannot be edited; it is automatically calculated.

End: The X, Y and Z coordinates of where the cutter will be once the arc move is complete. You will not be able to edit this field if you are specifying a center point and angle (CP&A) arc.

Center: This is the X, Y and Z position of the center of the arc. You will not be able to edit this field if you are specifying an end point and radius (EP&R) arc or a Three Point arc. Also, the coordinate that does not lie in the plane of the arc cannot be edited; it is automatically carried forward from the last operation.

Angle: Number of degrees through which the cutter will travel. This value must lie between 0 and 360 degrees. You will be able to edit this field only if you are specifying a center point and angle (CP&A) arc.

Radius: Distance from the center of the arc to its edge. This value must be greater than 0. You will only be able to edit this value if you are specifying an end point and radius (EP&R) arc.

Plane: This determines whether the arc is to be milled in the XY-, ZX- or YZ-plane. If any of the Z coordinate values are tied to the Z home position, only XY-plane arcs may be selected.

Direction: Determines whether the arc moves clockwise (CW) or counterclockwise (CCW). Note that the direction of XZ arcs is judged looking Y+ (i.e. from the front of the machine). This is natural, but it is opposite of the way arcs are specified in G codes. Intercon automatically makes this translation when it generates CNC codes.

Connect Radius: This field works like the Linear Mill connect radius. It allows for the blending of an arc into the next line or arc operation.

Feedrate: Speed at which the cutter moves.

The feedrate can be toggled to modal, fixed or slave, this is indicated by the symbol beside the feedrate field. If the feedrate is modal then it will have the “M” symbol or if it is fixed it will have the “F” symbol shown below. The slave feedrate has no symbol and is set to the last modal feedrate set in the program, when the modal feedrate changes all the following slave feedrates change until the next modal feedrate is encountered.



Angle <= 180°: For end point and radius (EP&R) arcs, this field determines whether the arc is to be less than (YES) or greater than (NO) 180 degrees.

F4 - Tool Functions When you select the tool functions by pressing F4 - Tool the following screen appears:

Intercon Mill v1.25				Current Part: E_Z_PART.icn	
Operation #	Type	X	End Y	Z	N0003 Tool Change
0001	;Demo Program				Tool Number : 1
0002	Rapid	0.0000	-5.0000	0.1000	Description : .325 end mill
0003	Tool #0				Position X: 0.0000
0004	End Prog	0.0000	-5.0000	Home	Position Y: 0.0000
					Tool H Offset : 1
					Tool Height : -1.1234
					Tool D Offset : 1
					Tool Diameter : 0.3250
					Spindle Speed : 3000
					Spindle Dir. : CW (M3)
					Coolant Type : Flood (M8)
					Actual Change? : Yes

Toggle F3	Help F5	Math Help F6	Graph F8	Teach Mode F9	Accept F10
--------------	------------	-----------------	-------------	------------------	---------------

The following parameters for this tool change are as follows:

Tool Number: Number of the tool (between 1 and 200) to use. Entering this value pulls the current settings for this tool from the CNC software tool library. You may then edit the length offset, diameter offset and diameter values if you wish to redefine your tool. The length value is not editable.

Description: Description of the tool selected above, from the tool library.

Position: X and Y coordinates for the place at which the tool change will occur. This should be a place at which the current tool can be removed from the quill and the new tool can be inserted.

Tool H Offset: Index in the offset library (between 0 and 200) of the actual tool height offset.

Tool Height: Tool height associated with the H offset selected above. This field is not editable.

Tool D Offset: Index in the offset library (between 0 and 200) of the actual tool diameter.

Tool Diameter: Tool diameter associated with the D offset selected above.

Spindle Speed: Speed at which the spindle will rotate when the spindle is started after the tool change.

Spindle Direction: Direction in which the spindle will turn after the tool change. If this is set to CW or CCW, the spindle will be started automatically after the tool change. Press **F3 - Toggle** or **SPACE** to toggle between CW, CCW, and Off.

Coolant Type: Type of coolant to activate after the tool change. If this is set to Flood or Mist, the selected coolant system will be started automatically after the tool change. Press **F3 - Toggle** or **SPACE** to toggle between Flood, Mist, and Off.

Actual Tool Change: Determines whether an M6 code is generated (answer Yes) during the tool change. If you do not want to remove the current tool, but instead want to alter its diameter or length offsets (e.g. for doing a finish pass while using cutter compensation, you may want to use a diameter offset which is slightly larger than the actual tool for the first passes, then use the actual tool diameter for the finish pass), answer No to this question. Spindle and coolant will not be automatically turned off if you answer No here.

Press **F10 - Accept**, **Page Up**, or **Page Down** when you are finished to accept these values and make changes to the tool library. If you have changed any field other than the Tool Number of the Actual Tool Change field or position, you will make changes to the CNC software Tool Library. At the end of the program, Intercon always turns off the spindle and coolant and returns the Z-axis to the home position. These codes do not need to be entered at the end of your program.

F5 - Canned Cycles When you choose the Canned Cycle operation by pressing F5 - Cycles, the following screen appears:

Operation		X	End Y	Z	
#	Type				
0001	;Demo Program				Select operation to insert...
0002	Rapid	0.0000	-5.0000	0.1000	
0003	Tool #1	0.0000	0.0000	Home	
0004	Line	4.0000	0.0000	1.0000	
0005	Line	4.0000	2.0000	1.0000	
0006	Line	7.0000	3.0000	1.0000	
0007	Arc CW	10.0000	3.0000	1.0000	
0008	Tool #2	0.0000	0.0000	Home	
<hr/>					
0009	End Prog	0.0000	0.0000	Home	

Drill ... F1	Bore ... F2	Tap ... F3	Face F4	Rect. Pocket F5	Circ. Pocket F6	Frame F7	Thread F8	Clean- out F9
--------------------	-------------------	------------------	------------	-----------------------	-----------------------	-------------	--------------	---------------------

Canned Cycle Introduction #1: Using Pattern and Repeat

(Drilling, boring, tapping)

Selecting **F1 - Drill** will give you four choices; **F1 - Drill**, **F2 - Drill BHC**, **F3 - Drill Array**, or **F4 - Drill Repeat**. **F2 - Bore** and **F3 - Tap** will have the same menu selections as drill except they will display Bore or Tap cycles

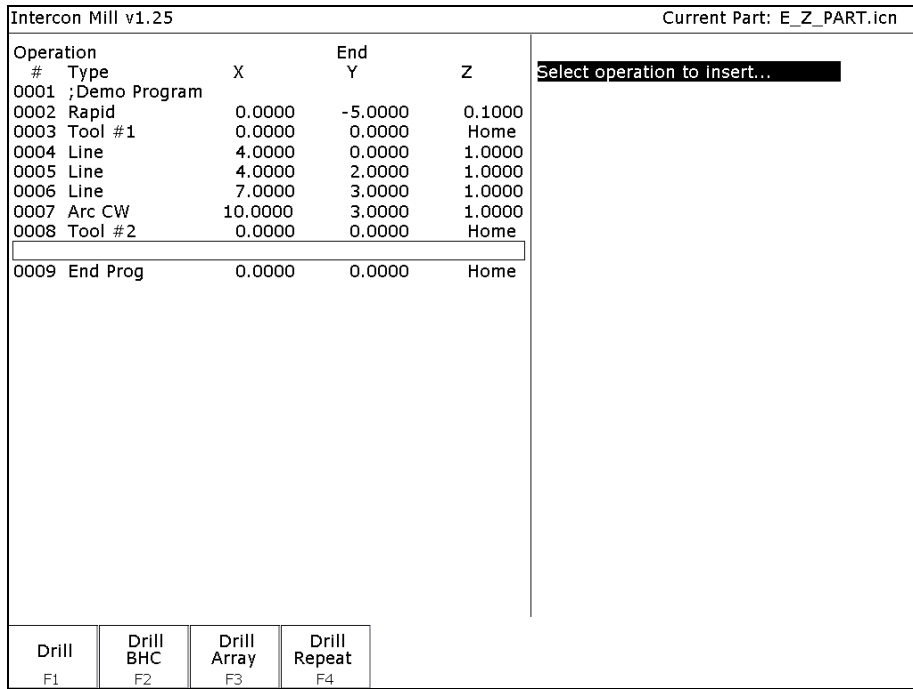

All canned cycle operations using the Drill BHC (Bolt Hole Circle) or Drill Array are identical to their equivalent using the **F1 - Drill** single hole selection. The use of the Drill BHC or Drill Array, however, offers the option to drill more than one hole in a pattern dictated by the new fields in the menu. **F4 - Drill Repeat** allows the user to repeat a set of holes with a different type drilling, boring or tapping operation with out re-entering the X, Y coordinates. The Bolt Hole Circle and array patterns are explained graphically in the following figure:

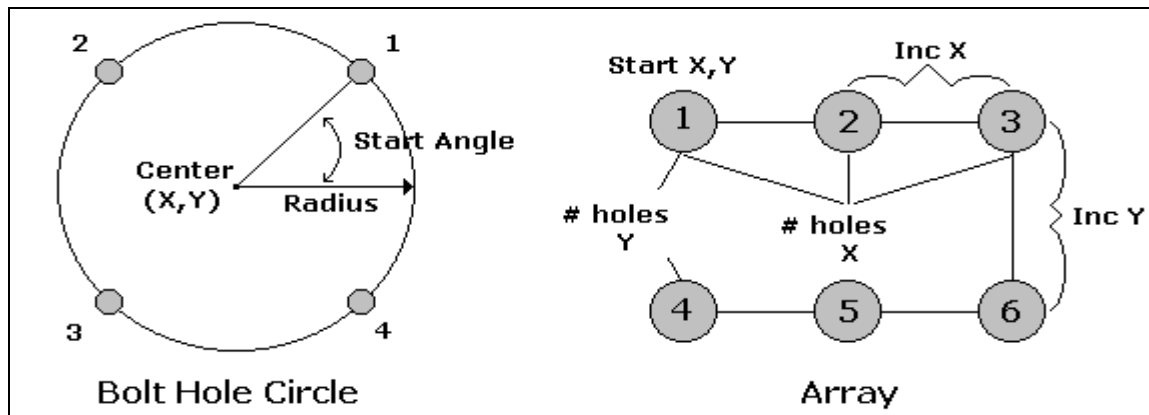

Canned Cycle Introduction #2: Linear Repetition of Operations (Drilling, Boring, Tapping)

If you want to perform one operation several times in a linear pattern, simply define Position X, Y or both as incremental values. To do this, use the **F1 – Abs/Inc** Key. This key will toggle the Position value mode between incremental and absolute. If you define X and/or Y as incremental values, a new field will appear asking for the number of holes:

Intercon Mill v1.25					Current Part: E_Z_PART.icn	
Operation #	Type	X	End Y	Z	N0009 Drill	
0001	;Demo Program				Cycle Type	: Drilling
0002	Rapid	0.0000	-5.0000	0.1000	Position X:	4.0000 INC
0003	Tool #1	0.0000	0.0000	Home	Y:	-8.0000 INC
0004	Line	4.0000	0.0000	1.0000	Surface Height	: 0.1000
0005	Line	4.0000	2.0000	1.0000	Clearance Height	: 0.1000 INC
0006	Line	7.0000	3.0000	1.0000	"Rapid to" Depth	: 0.1000 INC
0007	Arc CW	10.0000	3.0000	1.0000	Depth: Total:	0.5000 INC
0008	Tool #2	0.0000	0.0000	Home	Plunge Rate	: 20.0000 M
0009	Drill				Dwell Time	: 1.00
0010	End Prog	0.0000	0.0000	Home	Number of Holes	: 5

The numbers in the fields on the screen correspond to the following example, shown here graphically:

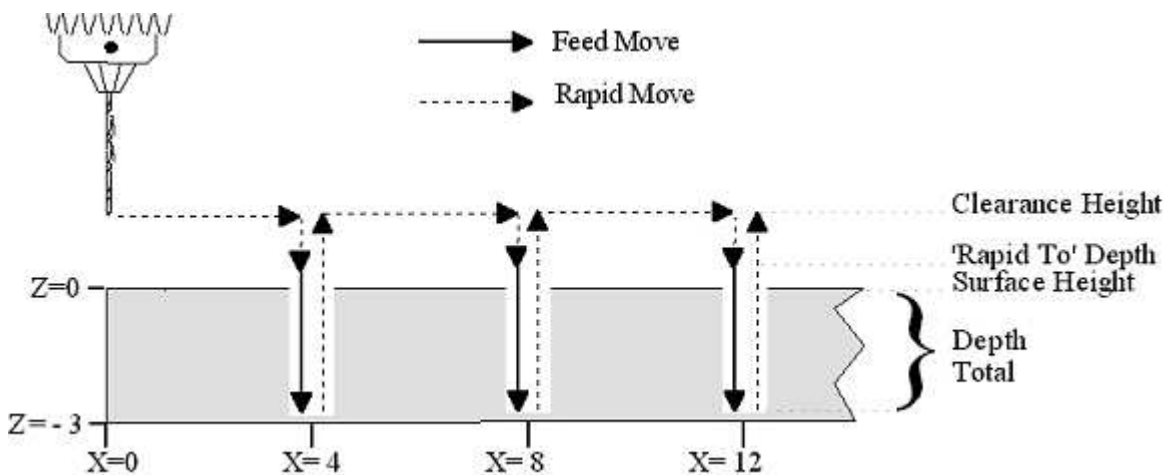

Drilling (F1 in the Canned Cycle Menu: option #1)

If you press **F1 - Drill** from the Canned Cycle Menu, you will gain access to three types of drilling operations: Drilling, Chip Breaking, and Deep Hole drilling. The current drilling operation in use is reflected in the field "Cycle Type" and pressing **F3 - Toggle** or **SPACE** toggles between all three. In this section we will examine the first option: Drilling.

Intercon Mill v1.25				Current Part: E_Z_PART.icn	
Operation #	Type	X	End Y	Z	N0009 Drill
0001	; Demo Program				Cycle Type : Drilling
0002	Rapid	0.0000	-5.0000	0.1000	Position X: 20.0000
0003	Tool #1	0.0000	0.0000	Home	Y: -40.0000
0004	Line	4.0000	0.0000	1.0000	Surface Height : 0.1000
0005	Line	4.0000	2.0000	1.0000	Clearance Height : 0.1000 INC
0006	Line	7.0000	3.0000	1.0000	"Rapid to" Depth : 0.1000 INC
0007	Arc CW	10.0000	3.0000	1.0000	Depth: Total: 0.5000 INC
0008	Tool #2	0.0000	0.0000	Home	Plunge Rate : 20.0000 M
0009	Drill				Dwell Time : 1.00
0010	End Prog	0.0000	0.0000	Home	

Help F5	Math Help F6	Graph F8	Teach Mode F9	Accept F10
------------	-----------------	-------------	------------------	---------------

The numbers in the fields on the screen correspond to the following example, shown here graphically:

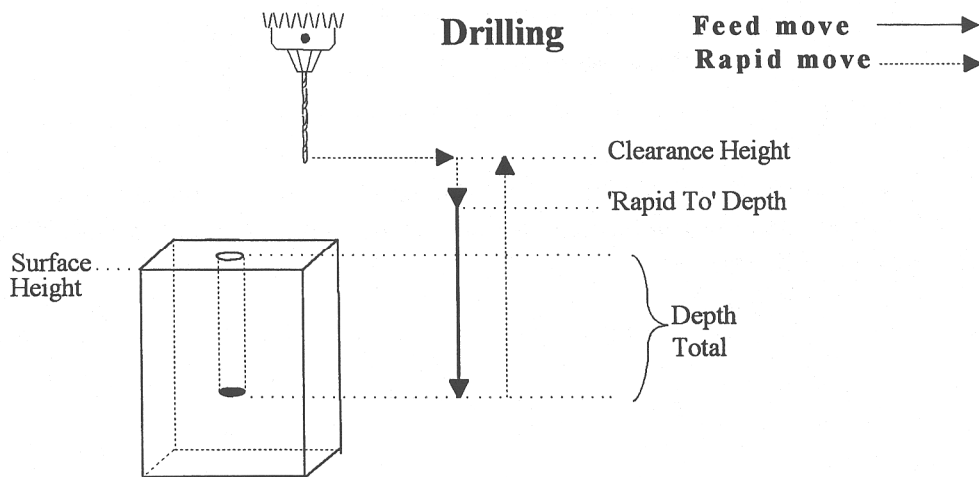

Where:

Cycle Type: Selects one of three drilling operations: Drilling, Chip Breaking, or Deep Hole drilling. Press **F3 - Toggle** or **SPACE** to toggle between the three choices.

Position: Specifies the X and Y coordinates where the drilling will take place. If either the X or Y coordinate is an incremental value, you will have the option to drill multiple holes in a linear pattern (See Canned Cycle Introduction #2).

Surface Height: Absolute Z-axis position from where each incremental depth is measured.

Clearance Height: This parameter specifies the Z-axis height used when performing rapid moves to the position of each hole being drilled.

'Rapid To' Depth: The depth to which the cutter rapid moves before beginning to drill the hole at the specified Plunge Rate. This is below the Clearance Height but above the Surface Height.

Depth: Total: Depth of hole (incremental) as measured from Surface Height.

Plunge Rate: Z-axis speed of descent during drilling.

The plunge rate can be toggled to modal, fixed or slave, this is indicated by the symbol beside the plunge rate field. If the plunge rate is modal then it will have the “M” symbol or if it is fixed it will have the “F” symbol. The slave plunge rate has no symbol and is set to the last modal plunge rate set in the program, when the modal plunge rate changes all the following slave plunge rates change until the next modal plunge rate is encountered.

Dwell Time: Delay at bottom of hole before starting ascent.

Drilling provides a rapid to the hole position at the Clearance Height, followed by a rapid Z down to the 'Rapid To' Depth. Next is a feedrate down to the specified depth. If a Spot facing cycle is desired, enter a value in the dwell time field and the cutter will wait the desired amount of time before performing a rapid move up to the Clearance Height.

Chip Breaking (F1 in the Canned Cycle Menu: option #2)

If you press **F1 - Drill** from the Canned Cycle Menu you will gain access to three types of drilling operations: Drilling, Chip Breaking, and Deep Hole drilling. The current drilling operation in use is reflected in the field Cycle Type, and pressing **F3 - Toggle** or **SPACE** toggles between all three. In this section we will examine the second option: Chip Breaking.

Intercon Mill v1.25				Current Part: E_Z_PART.icn	
Operation #	Type	X	End Y	Z	N0009 Drill
0001	;Demo Program				Cycle Type : Chip Breaking
0002	Rapid	0.0000	-5.0000	0.1000	Position X: 20.0000
0003	Tool #1	0.0000	0.0000	Home	Y: -40.0000
0004	Line	4.0000	0.0000	1.0000	Surface Height : 0.1000
0005	Line	4.0000	2.0000	1.0000	Clearance Height : 0.1000 INC
0006	Line	7.0000	3.0000	1.0000	"Rapid to" Depth : 0.1000 INC
0007	Arc CW	10.0000	3.0000	1.0000	Depth: Total: 0.5000 INC
0008	Tool #2	0.0000	0.0000	Home	Increment : 0.0000
0009	Drill				Peck Clearance : 0.0500
0010	End Prog	0.0000	0.0000	Home	Plunge Rate : 20.0000 M

Toggle F3	Help F5	Math Help F6	Graph F8	Teach Mode F9	Accept F10
--------------	------------	-----------------	-------------	------------------	---------------

The numbers in the fields on the screen correspond to the following example, shown here graphically:

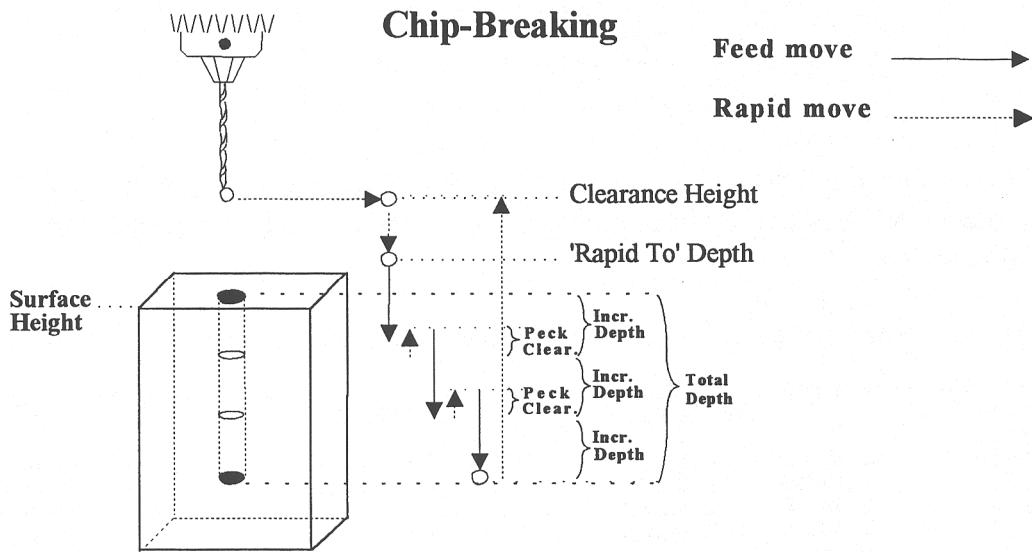

Where:

Cycle Type: Selects one of three drilling operations: Drilling, Chip Breaking, or Deep Hole drilling. Press **F3 - Toggle** or **SPACE** to toggle between the three choices.

Position: Specifies the X and Y coordinates where the drilling will take place. If either the X or Y coordinate is an incremental value, you will have the option to drill multiple holes in a linear pattern (See Canned Cycle Introduction #2).

Surface Height: Absolute Z-axis position from where each incremental depth is measured.

Clearance Height: This parameter specifies the Z-axis height used when performing rapid moves to the position of each hole being drilled.

'Rapid To' Depth: The depth to which the cutter rapid moves before beginning to drill the hole at the specified Plunge Rate. This is below the Clearance Height but above the Surface Height.

Depth: Total: Depth of hole (incremental) as measured from Surface Height.

Depth: Increment: Depth of each individual peck.

Peck Clearance: Distance the tool retracts before drilling the next peck.

Plunge Rate: Z-axis speed of descent during drilling.

The plunge rate can be toggled to modal, fixed or slave, this is indicated by the symbol beside the plunge rate field. If the plunge rate is modal then it will have the "M" symbol or if it is fixed it will have the "F" symbol. The slave plunge rate has no symbol and is set to the last modal plunge rate set in the program, when the modal plunge rate changes all the following slave plunge rates change until the next modal plunge rate is encountered.

Deep Hole Drilling (F1 in the Canned Cycle Menu: option #3)

If you press **F1 - Drill** from the Canned Cycle Menu you will gain access to three types of drilling operations: Drilling, Chip Breaking, and Deep Hole drilling. The current drilling operation in use is reflected in the field Cycle Type, and pressing **F3 - Toggle** or **SPACE** toggles between all three. In this section we will examine the third option: Deep Hole drilling.

Intercon Mill v1.25				Current Part: E_Z_PART.icn	
Operation #	Type	X	End Y	Z	N0009 Drill
0001	;Demo Program				Cycle Type : Deep Hole
0002	Rapid	0.0000	-5.0000	0.1000	Position X: 20.0000
0003	Tool #1	0.0000	0.0000	Home	Position Y: -40.0000
0004	Line	4.0000	0.0000	1.0000	Surface Height : 0.1000
0005	Line	4.0000	2.0000	1.0000	Clearance Height : 0.1000 INC
0006	Line	7.0000	3.0000	1.0000	"Rapid to" Depth : 0.1000 INC
0007	Arc CW	10.0000	3.0000	1.0000	Depth: Total: 0.5000 INC
0008	Tool #2	0.0000	0.0000	Home	Increment : 0.1000
0009	Drill				Rapid Clearance : 0.0500
0010	End Prog	0.0000	0.0000	Home	Plunge Rate : 20.0000 M

Toggle F3	Help F5	Math Help F6	Graph F8	Teach Mode F9	Accept F10
--------------	------------	-----------------	-------------	------------------	---------------

The numbers in the fields on the screen correspond to the following example, shown here graphically:

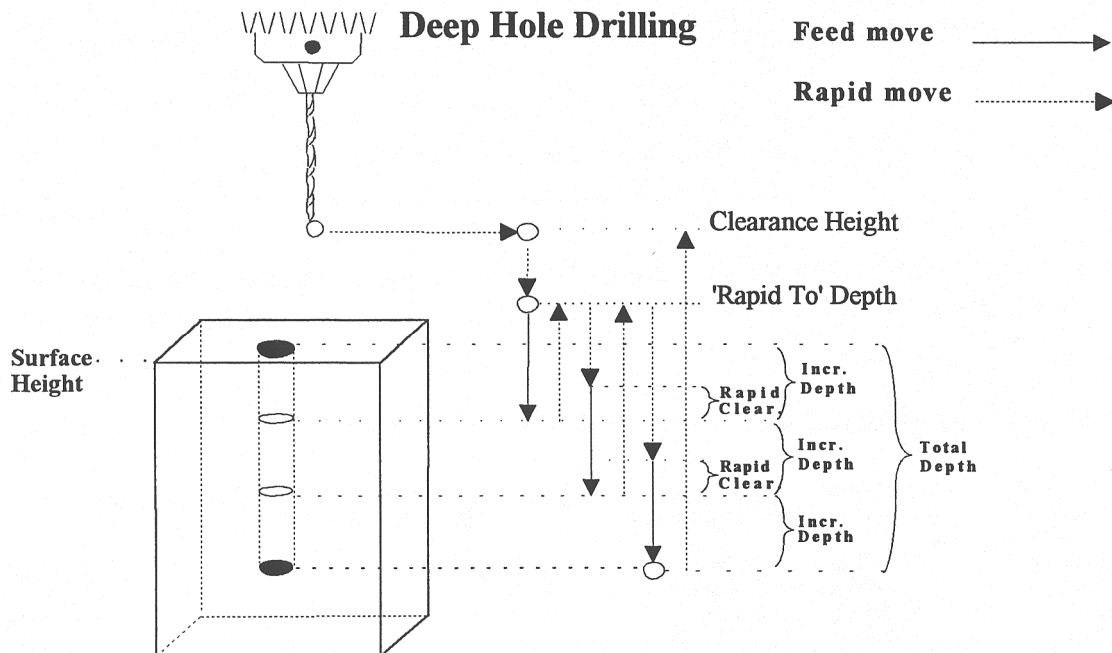

Where:

Cycle Type: Selects one of three drilling operations: Drilling, Chip Breaking, or Deep Hole drilling. Press **F3-Toggle** or **SPACE** to toggle between the three choices.

Position: Specifies the X and Y coordinates where the drilling will take place. If either the X or Y coordinate is an incremental value, you will have the option to drill multiple holes in a linear pattern (See Canned Cycle Introduction #2).

Surface Height: Absolute Z-axis position from where each incremental depth is measured.

Clearance Height: This parameter specifies the Z-axis height used when performing rapid moves to the position of each hole being drilled.

'Rapid To' Depth: The depth to which the cutter rapid moves before beginning to drill the hole at the specified Plunge Rate. This is below the Clearance Height but above the Surface Height.

Depth: Total: Depth of hole (incremental) as measured from Surface Height.

Depth: Increment: Depth of each individual step of the drilling.

Rapid Clearance: Distance from the last incremental depth drilled that the tool rapid moves before starting the next plunge.

Plunge Rate: Z-axis speed of descent during drilling.

The plunge rate can be toggled to modal, fixed or slave, this is indicated by the symbol beside the plunge rate field. If the plunge rate is modal then it will have the "M" symbol or if it is fixed it will have the "F" symbol. The slave plunge rate has no symbol and is set to the last modal plunge rate set in the program, when the modal plunge rate changes all the following slave plunge rates change until the next modal plunge rate is encountered.

Boring (F2 in the Canned Cycle Menu)

If you press **F2 - Bore** from the Canned Cycle Menu you will gain access to the boring operation:

Intercon Mill v1.25				Current Part: E_Z_PART.icn	
Operation #	Type	X	End Y	Z	N0009 Bore
0001	;Demo Program				Position X: 4.0000
0002	Rapid	0.0000	-5.0000	0.1000	Y: -8.0000
0003	Tool #1	0.0000	0.0000	Home	Surface Height : 0.1000
0004	Line	4.0000	0.0000	1.0000	Clearance Height : 0.1000 INC
0005	Line	4.0000	2.0000	1.0000	"Rapid to" Depth : 0.1000 INC
0006	Line	7.0000	3.0000	1.0000	Hole Depth : 0.5000 INC
0007	Arc CW	10.0000	3.0000	1.0000	Plunge Rate : 20.0000 M
0008	Tool #2	0.0000	0.0000	Home	Dwell Time : 1.00
0009	Bore				
0010	End Prog	0.0000	0.0000	Home	

Help F5	Math Help F6	Graph F8	Teach Mode F9	Accept F10
------------	-----------------	-------------	------------------	---------------

The numbers in the fields on the screen correspond to the following example, shown here graphically:

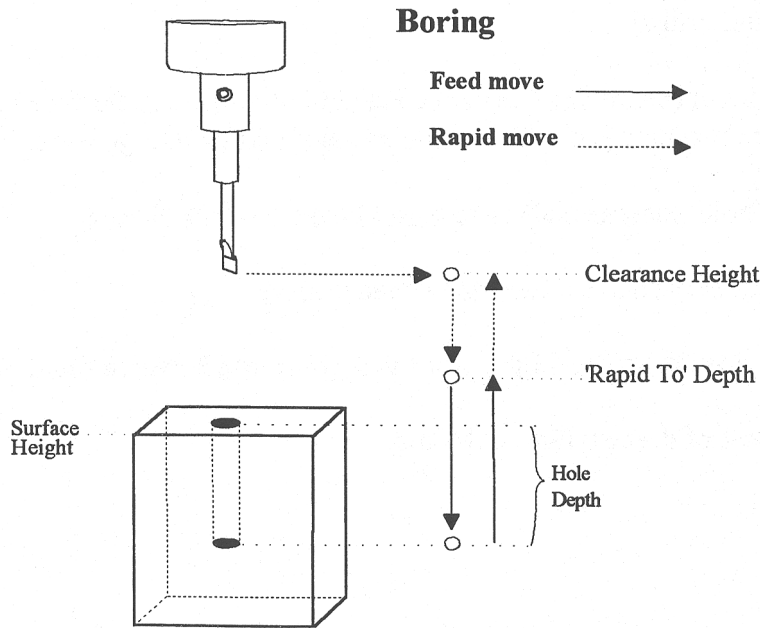

Where:

Position: Specifies the X and Y coordinates where the boring will take place. If either the X or Y coordinate is an incremental value, you will have the option to bore multiple holes in a linear pattern. (See Canned Cycle Introduction #2)

Surface Height: Absolute Z-axis position from where each incremental depth is measured.

Clearance Height: This parameter specifies the Z-axis height used when performing rapid moves to the position of each hole being drilled.

'Rapid To' Depth: The depth to which the cutter rapid moves before beginning to drill the hole at the specified Plunge Rate. This is below the Clearance Height but above the Surface Height.

Hole Depth: Depth of hole (incremental) as measured from Surface Height.

Plunge Rate: Z-axis speed of descent during drilling.

The plunge rate can be toggled to modal, fixed or slave, this is indicated by the symbol beside the plunge rate field. If the plunge rate is modal then it will have the "M" symbol or if it is fixed it will have the "F" symbol. The slave plunge rate has no symbol and is set to the last modal plunge rate set in the program, when the modal plunge rate changes all the following slave plunge rates change until the next modal plunge rate is encountered.

Dwell Time: Delay at bottom of hole before starting ascent.

Tapping (F2 in the Canned Cycle Menu)

If you press **F2 - Tap** from the Canned Cycle Menu you will gain access to the tapping operations:

Intercon Mill v1.25			Current Part: E_Z_PART.icn		
Operation #	Type	X	End Y	Z	N0009 Tap
0001	;Demo Program				Tap Head Type : Rigid
0002	Rapid	0.0000	-5.0000	0.1000	Position X: 0.0000
0003	Tool #1	0.0000	0.0000	Home	Position Y: 0.0000
0004	Line	4.0000	0.0000	1.0000	Surface Height : 0.0000
0005	Line	4.0000	2.0000	1.0000	Clearance Height : 0.1000 INC
0006	Line	7.0000	3.0000	1.0000	"Rapid to" Depth : 0.1000 INC
0007	Arc CW	10.0000	3.0000	1.0000	Depth: Total: 0.5000 INC
0008	Tool #2	0.0000	0.0000	Home	Increment : 0.0000
0009	Tap	0.0000	0.0000	0.1000	Threads / Inch : 12.0000
0010	End Prog	0.0000	0.0000	Home	Thread Pitch : 0.0833
					Dwell Time : 0.10
					(Spindle Dir. : CW (M3))
					(Spindle Speed : 350)

Help
F5

Math Help
F6

Graph
F8

Teach Mode
F9

Accept
F10

The numbers in the fields on the screen correspond to the following example, shown here graphically:

Tapping

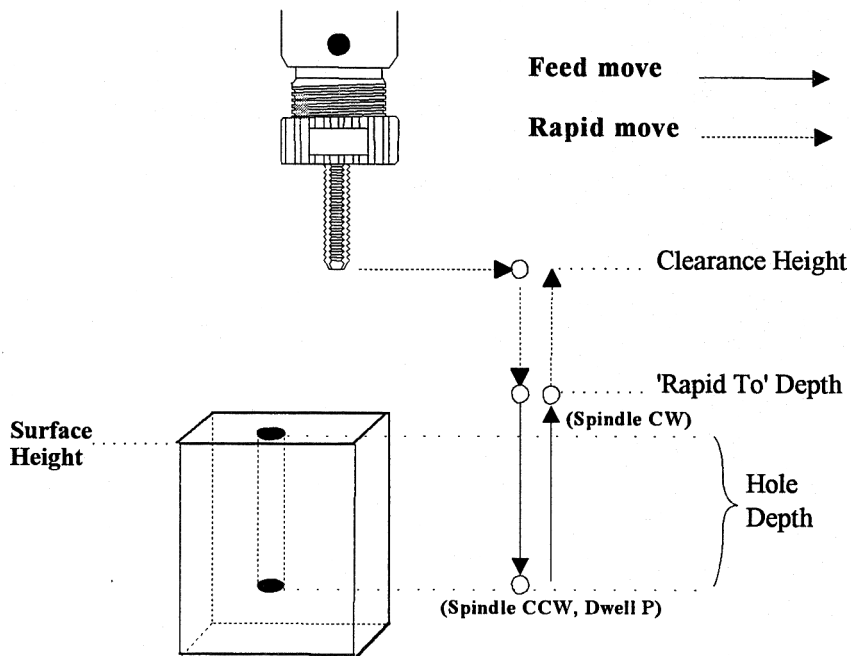

Where:

Tap Head Type: Without rigid tapping, this selects either Floating tap head or Reversing tap head (where the special tapping head reverses for you). If rigid tapping is enabled (requires a spindle encoder), you can select either rigid or reversing.

Spindle Direction: Shows the current spindle direction. The spindle direction should be CW for right-hand tapping, and CCW for left-hand tapping. The spindle speed and direction appropriate for the tapping tool should be set in the tool change in which the tapping tool was loaded. This field will be hidden if a reversing tap head is used.

* **WARNING:** The tap must be rotating in the correct direction before performing this operation.

Position: Specifies the X and Y coordinates where the tapping will take place. If either the X or Y coordinate is an incremental value, you will have the option to tap multiple holes in a linear pattern. (See Canned Cycle Introduction #2)

Surface Height: Absolute Z-axis position from where each incremental depth is measured.

Clearance Height: This parameter specifies the Z-axis height used when performing rapid moves to the position of each hole being drilled.

'Rapid To' Depth: The depth to which the cutter rapid moves before beginning to drill the hole at the specified Plunge Rate. This is below the Clearance Height but above the Surface Height.

Depth Total: Depth of hole (incremental) as measured from Surface Height.

Depth Increment: (available only on rigid tapping.) This sets the length of each progressive "peck" down the hole.

Threads / Unit: Number of threads on each inch/mm of the tap. Used in conjunction with the Spindle Speed to calculate the appropriate plunge rate ($\text{Plunge Rate} = \text{Spindle Speed} / \text{Threads per Unit}$).

Spindle Speed: Rate at which the spindle rotates. Used in conjunction with the Threads / Unit to calculate the plunge rate.

* **WARNING:** The spindle speed must be set before performing this operation.

Dwell Time: Delay at bottom of hole before starting ascent. This is used for a floating tap to allow the spindle time to reverse direction at the bottom of the hole. A default value of 0.1 seconds is suggested. This field will be hidden if a reversing tap head is used; the tap head will reverse direction when the quill begins ascending.

* **NOTE:** When using low gear for tapping, the spindle may turn opposite the direction specified. The operator is responsible for setting the correct spindle speed and direction.

Facing (F4 in the Canned Cycle Menu)

If you press **F4 - Face** at the Canned Cycle Selection Menu, the following screen is displayed:

Intercon Mill v1.25				Current Part: E_Z_PART.icn	
Operation #	Type	X	End Y	Z	N0010 Face
0001	;Demo Program				Start
0002	Rapid	0.0000	-5.0000	0.1000	X: 3.0000
0003	Tool #1	0.0000	0.0000	Home	Y: 3.0000
0004	Line	4.0000	0.0000	1.0000	: 0.0000
0005	Line	4.0000	2.0000	1.0000	Surface Height
0006	Line	7.0000	3.0000	1.0000	Length X: 3.0000 INC
0007	Arc CW	10.0000	3.0000	1.0000	Width Y: 3.0000 INC
0008	Tool #2	0.0000	0.0000	Home	Depth : 0.5000 INC
0009	Tap	0.0000	0.0000	0.1000	Step Increment : 0.1000
0010	Face				Feedrate : 30.0000 M
0011	End Prog	0.0000	0.0000	Home	Plunge Rate : 10.0000 M

Toggle	Help	Math Help	Graph	Teach Mode	Accept
F3	F5	F6	F8	F9	F10

The parameters in the previous screen correspond to the following dimensions:

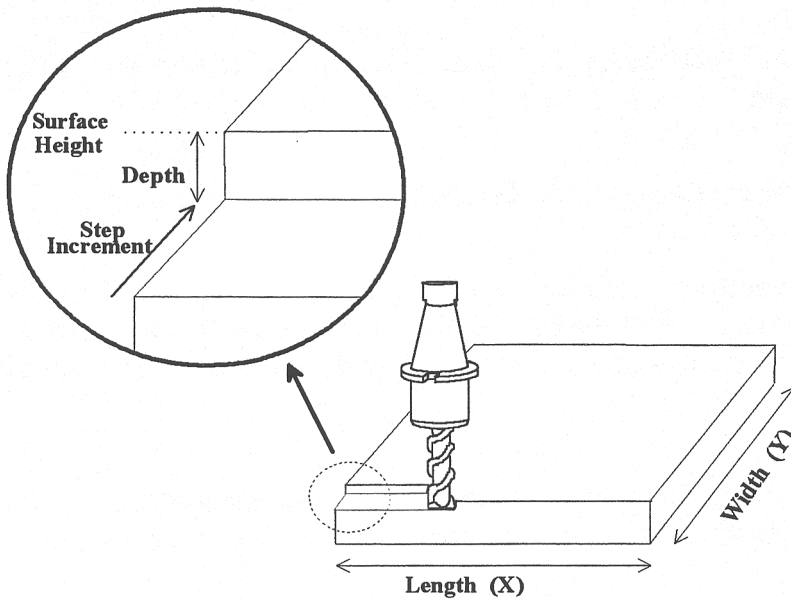

Start: X and Y coordinates of the starting corner of the area to be faced.

Surface Height: Z coordinate of the top of the area to be faced.

Length: X-axis dimension of the area to be faced. If a negative value is entered for the length, the facing will occur in the negative X-axis direction from the X-axis start position; otherwise, facing will occur in the positive X-axis direction from the X-axis start position.

Width: Y-axis dimension of the area to be faced. If a negative value is entered for the width, the facing will occur in the negative Y-axis direction from the Y-axis start position; otherwise, facing will occur in the positive Y-axis direction from the Y-axis start position.

Depth: Incremental amount of material to be removed from Surface Height.

Step Increment: Distance that the cutter will step over in the Y direction for each pass.

Plunge Rate: Z-axis speed of descent during facing.

The plunge rate can be toggled to modal, fixed or slave, this is indicated by the symbol beside the plunge rate field. If the plunge rate is modal then it will have the “M” symbol or if it is fixed it will have the “F” symbol. The slave plunge rate has no symbol and is set to the last modal plunge rate set in the program, when the modal plunge rate changes all the following slave plunge rates change until the next modal plunge rate is encountered.

Feedrate: Speed of the cutter during facing.

The feedrate can be toggled to modal, fixed or slave, this is indicated by the symbol beside the feedrate field. If the feedrate is modal then it will have the “M” symbol or if it is fixed it will have the “F” symbol shown below. The slave feedrate has no symbol and is set to the last modal feedrate set in the program, when the modal feedrate changes all the following slave feedrates change until the next modal feedrate is encountered.



Rectangular Pocket (F5 in the Canned Cycle Menu)

Pressing **F5 - Rect. Pocket** from the Canned Cycle Selection Menu displays the following screen:

Intercon Mill v1.25				Current Part: E_Z_PART.icn	
Operation #	Type	X	End Y	Z	N0011 Rectangular Pocket
0001	;Demo Program				Center X: 4.0000
0002	Rapid	0.0000	-5.0000	0.1000	Y: -8.0000
0003	Tool #1	0.0000	0.0000	Home	Surface Height : 0.0000
0004	Line	4.0000	0.0000	1.0000	Length X: 5.0000 INC
0005	Line	4.0000	2.0000	1.0000	Width Y: 3.0000 INC
0006	Line	7.0000	3.0000	1.0000	Corner Radius : 0.2500
0007	Arc CW	10.0000	3.0000	1.0000	Depth: Total: 0.5000 INC
0008	Tool #2	0.0000	0.0000	Home	per Pass : 0.1000
0009	Tap	0.0000	0.0000	0.1000	Plunge Rate : 10.0000
0010	Face	3.0000	6.0000	0.1000	Plunge Type : Ramped
0011	Rect Poc				Plunge Angle : 0.0000°
0012	End Prog	3.0000	6.0000	Home	Rough Cuts : Conventional
					Stepover : 0.1950
					Feedrate : 30.0000 M
					Finish Pass : Climb
					Amount : 0.0200
					Feedrate : 30.0000

Toggle F3	Help F5	Math Help F6	Graph F8	Teach Mode F9	Accept F10
--------------	------------	-----------------	-------------	------------------	---------------

The parameters on the screen correspond to the following dimensions:

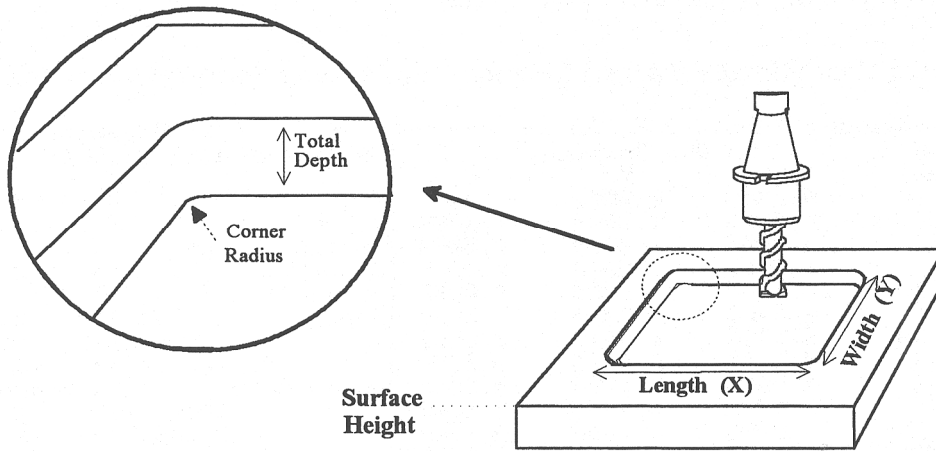

Where:

Center or Corner: Center - X and Y coordinates of the center of the Rectangular Pocket.

Corner – X and Y coordinates of the corner of the rectangular pocket. A positive or negative value in the length and width fields will determine the location of the rectangular pocket from the corner position.

Surface Height: Z-axis position from which each incremental depth is measured.

Length: X-axis dimension of the rectangular pocket.

Width: Y-axis dimension of the rectangular pocket.

Corner Radius: Radius of curvature of the corners. It cannot be smaller than the current cutter radius.

Depth: Total: Total depth of the rectangular pocket.

Depth: Per Pass: Depth of each individual pass.

Depth: Plunge Rate: Z-axis speed of descent.

Depth: Plunge Type: Straight or Ramped. Straight plunge does a vertical Z plunge with no X, Y movement. Ramped plunge does a zigzag plunge limited by the Plunge Angle entered below.

Depth: Plunge Angle: The maximum limit angle allowed for a ramped plunge. A special value of 0 means that there is no limit angle. Note: This field means nothing if the Plunge Type is Straight.

Rough Cuts: Selects type of rough cut: conventional or climb. Use **F3 – Toggle** or **SPACE** to toggle between them.

Rough Cuts: Stepper: Amount of material removed by cutter during each pass around the pocket.

Rough Cuts: Feedrate: Speed at which cutter performs rough cuts.

Finish Pass: Selects type of finish pass: climb, conventional or none at all. Use **F3 - Toggle** or **SPACE** to toggle between them.

Finish Pass: Amount: Amount of material to be removed on the finish pass.

Finish Pass: Feedrate: Speed at which cutter performs finish pass.

The feedrate can be toggled to modal, fixed or slave, this is indicated by the symbol beside the feedrate field. If the feedrate is modal then it will have the “M” symbol or if it is fixed it will have the “F” symbol shown below. The slave feedrate has no symbol and is set to the last modal feedrate set in the program, when the modal feedrate changes all the following slave feedrates change until the next modal feedrate is encountered.



Circular Pocket (F6 in the Canned Cycle Menu)

When you press **F6 - Circ. Pocket** from the Canned Cycle Selection Menu, this screen is displayed:

Intercon Mill v1.25				Current Part: E_Z_PART.icn	
Operation #	Type	X	End Y	Z	N0012 Circular Pocket
0001	;Demo Program				Center X: 4.0000
0002	Rapid	0.0000	-5.0000	0.1000	Y: -8.0000
0003	Tool #1	0.0000	0.0000	Home	Surface Height : 0.0000
0004	Line	4.0000	0.0000	1.0000	Diameter : 2.0000
0005	Line	4.0000	2.0000	1.0000	Cleanout : Yes
0006	Line	7.0000	3.0000	1.0000	Depth: Total: 0.5000 INC
0007	Arc CW	10.0000	3.0000	1.0000	per Pass : 0.1000
0008	Tool #2	0.0000	0.0000	Home	Plunge Rate : 10.0000
0009	Tap	0.0000	0.0000	0.1000	Plunge Type : Ramped
0010	Face	3.0000	6.0000	0.1000	Plunge Angle : 0.0000°
0011	Rect Poc	4.0000	-8.0000	0.1000	Rough Cuts : Conventional
0012	Circ Poc				Stepover : 0.1950
0013	End Prog	4.0000	-8.0000	Home	Feedrate : 30.0000
					Finish Pass : Climb
					Amount : 0.0200
					Feedrate : 30.0000

Abs Inc F1	Help F5	Math Help F6	Graph F8	Teach Mode F9	Accept F10
---------------	------------	-----------------	-------------	------------------	---------------

The parameters on the screen correspond to the following dimensions:

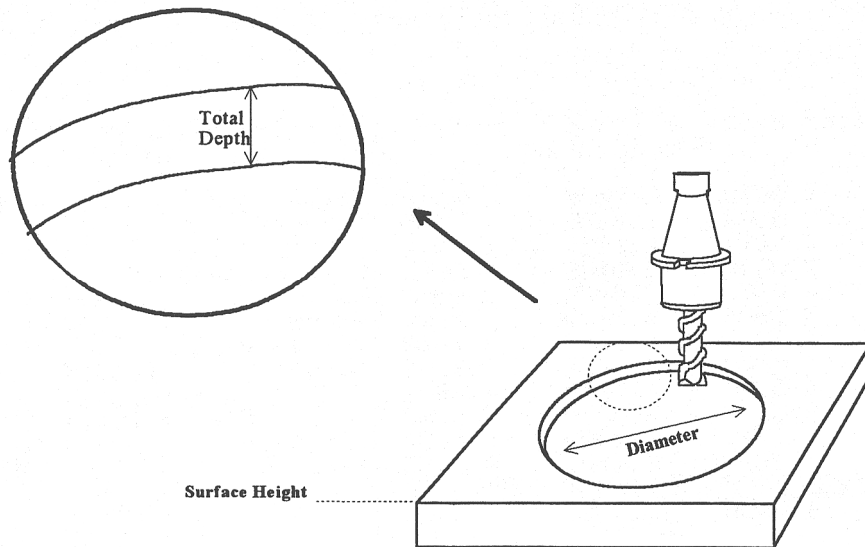

Where:

Center: X and Y coordinates of the center of the circular Pocket.

Surface Height: Z-axis position from which each incremental depth is measured.

Diameter: Diameter of circular pocket.

Cleanout: If cleanout is Yes, then all the material in the pocket will be removed. If cleanout is No, then all the material will not be removed. The cutter starts in the center of the pocket and arcing its way out and then going around the frame.

Depth: Total: Total depth of the circular pocket.

Depth: Per Pass: Depth of each individual pass.

Depth: Plunge Rate: Z-axis speed of descent.

Depth: Plunge Type: Straight or Ramped. Straight plunge does a vertical Z plunge with no X, Y movement. Ramped plunge does a zigzag plunge limited by the Plunge Angle entered below.

Depth: Plunge Angle: The maximum limit angle allowed for a ramped plunge. A special value of 0 means that there is no limit angle. Note: This field means nothing if the Plunge Type is Straight.

Rough Cuts: Selects type of rough cut: conventional or climb. Use **F3 - Toggle** or **SPACE** to toggle between them.

Rough Cuts: Stepmover: Amount of material removed by cutter during each pass around the pocket.

Rough Cuts: Feedrate: Speed at which cutter performs rough cuts.

Finish Pass: Selects type of finish pass: climb, conventional or none at all. Use **F3 - Toggle** or **SPACE** to toggle.

Finish Pass: Amount: Amount of material to be removed on the finish pass.

Finish Pass: Feedrate: Speed at which cutter performs finish pass.

Rectangular or Circular Frame Milling (F7 in the Canned Cycle Menu)

When you press **F7 - Frame** from the Canned Cycle Selection Menu, the following screen is displayed:

Intercon Mill v1.25				Current Part: E_Z_PART.icn	
Operation #	Type	X	End Y	Z	N0004 Frame
0001	;Demo Program				Frame Type : Inside Rect
0002	Rapid	0.0000	-5.0000	0.1000	Center X: 0.0000
0003	Tool #1	0.0000	0.0000	Home	Center Y: 0.0000
0004	Frame				Surface Height : -1.0000
0005	End Prog	0.0000	0.0000	Home	Length X: 6.0000 INC
					Width Y: 3.0000 INC
					Corner Radius : 0.0000
					Depth: Total: 1.0000 INC
					per Pass : 0.1000
					Plunge Rate : 1.0000 M
					Plunge Type : Ramped
					Plunge Angle : 0.0000°
					Cut Type : Conventional
					Feedrate : 1.0000 M

Toggle F3	Help F5	Math Help F6	Graph F8	Teach Mode F9	Accept F10
--------------	------------	-----------------	-------------	------------------	---------------

The parameters on the screen correspond to the following dimensions (rectangular frame):

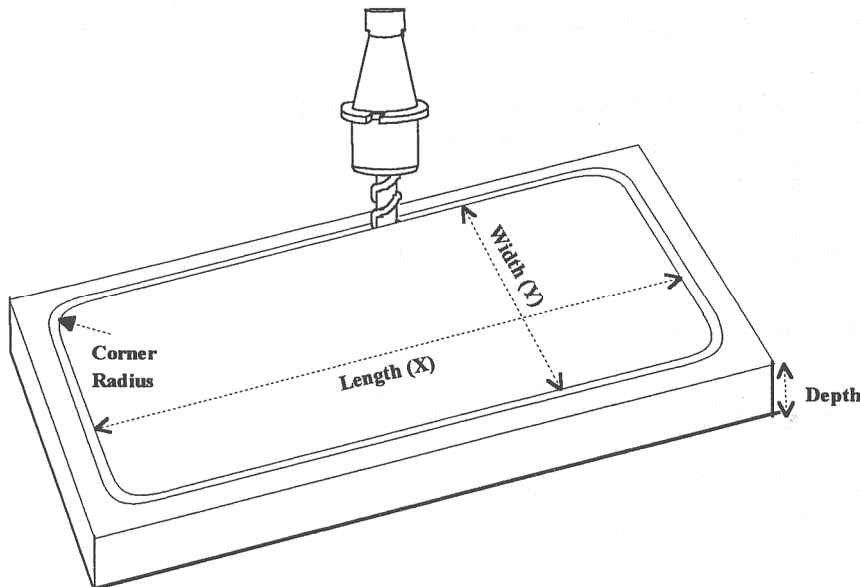

Where:

Frame Type: Selects Inside Rectangle, Outside Rectangle, Inside Circle, and Outside Circle. Press **F3 - Toggle** or **SPACE** to toggle between them.

Center: X and Y coordinates of the center of the frame mill.

Surface Height: Z-axis position from where each incremental depth is measured.

Length: X-axis dimension of the frame mill. (Rectangular frame only.)

Width: Y-axis dimension of the frame mill. (Rectangular frame only.)

Corner Radius: Radius of curvature of the corners. On an Inside frame, corner radius must be greater than the current cutter radius. (Rectangular frame only.)

Diameter: Diameter of the frame mill. (Circular frame only)

Depth: Total: Total depth of the frame mill.

Depth: Per Pass: Depth of each individual pass.

Plunge Rate: Z-axis speed of descent.

Plunge Type: Straight or Ramped. Straight plunge does a vertical Z plunge with no X, Y movement. Ramped plunge does a zigzag plunge limited by the Plunge Angle entered below.

Plunge Angle: The maximum limit angle allowed for a ramped plunge. A special value of 0 means that there is no limit angle. Note: This field means nothing if the Plunge Type is Straight.

Entrance Type: Selects type of entrance: Arc On or Arc Off, use **F3 - Toggle** or **SPACE** to toggle between them. (Circular frame only)

Cut type: Selects type of cut: conventional or climb, use **F3 - Toggle** or **SPACE** to toggle between them.

Feedrate: Speed at which the cutter performs frame mill.

NOTE: To make a circular frame mill of radius R, specify R as the Corner Radius and set the Length and Width parameters equal to 2 x R.

Thread Milling (F8 in the Canned Cycle Menu)

When you press **F8 - Thread** from the canned cycle menu, the following screen is displayed:

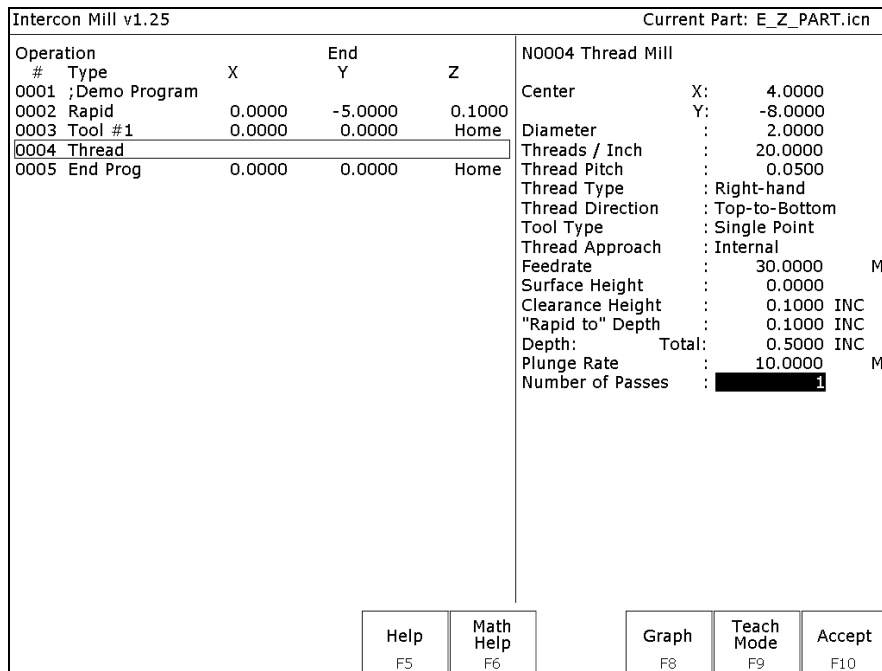

Multiple Thread Mill

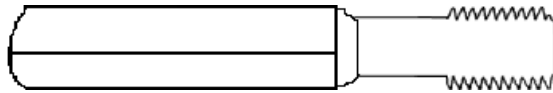

Single Thread Mill

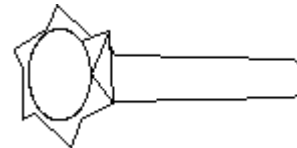

The parameters on the screen correspond to the following:

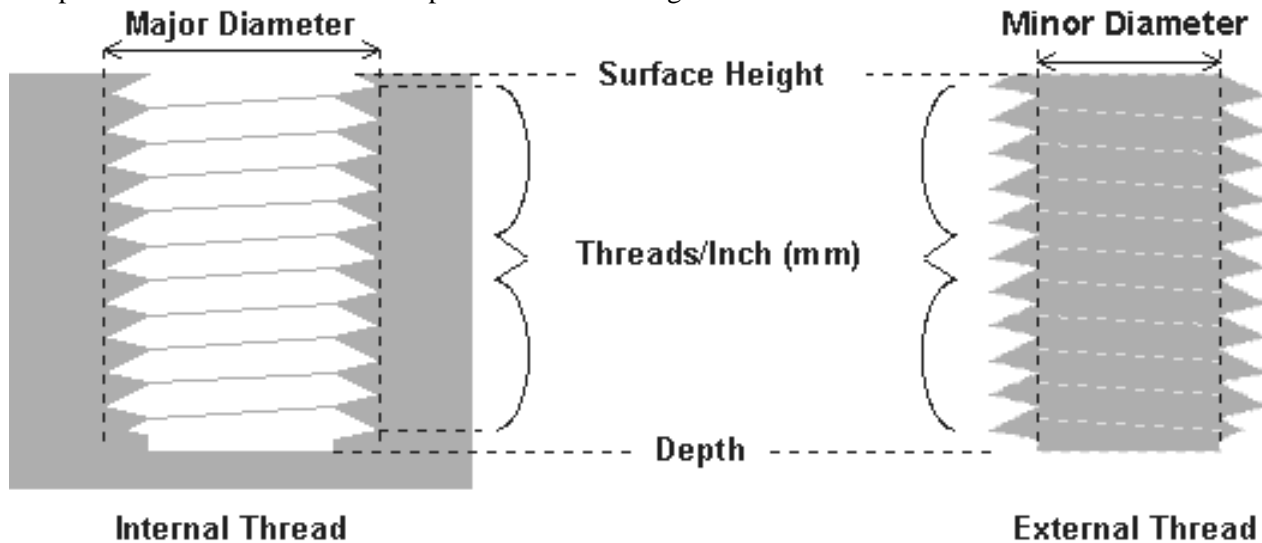

Where:

Center: X and Y coordinates of the center of the thread mill operation.

Diameter: Major diameter of thread for internal thread milling and minor diameter for external thread milling.

Thread / Unit: Number of threads per inch or mm. Used to calculate thread pitch.

Thread Pitch: Thread pitch calculated from threads/unit field. This field cannot be modified.

Thread Type: Specifies right or left hand threads.

Thread Direction: Specifies whether to start at the bottom of the hole and work up or start at the top of the hole and work down.

Tool Type: Single point or full form threading tool.

Thread Approach: Internal or external thread.

Clearance Amount: Used for external thread milling only. Specifies the diameter of the lead-in arc. Minimum clearance is 0.050 inches.

Clearance Angle: Used for external thread milling only. Specifies the angle from which the lead in arc will start.

Feedrate: Cutting feed rate.

Surface Height: Absolute Z-axis position from position from where the incremental depth is measured.

Clearance Height: This parameter specifies the Z axis height used when performing rapid moves to the position of each hole being thread.

'Rapid to' Depth: The depth to which the cutter rapid moves before beginning to thread mill at the specified Plunge Rate. This is below the Clearance Height but above the Surface Height.

Depth: The total depth of the thread.

Number of Passes: Number of times the thread mill is to be done on the same hole.

Cleanout (F9 in the Canned Cycle Menu)

The cleanout cycle performs a horizontal zigzag pocket cleanout of a profile composed of lines and arcs. When you press **F9 - Cleanout** from the canned cycle menu, the following screen is displayed:

Intercon Mill v1.25				Current Part: E_Z_PART.icn	
Operation #	Type	X	End Y	Z	
0001	;Demo Program				
0002	Rapid	0.0000	-5.0000	0.1000	
0003	Tool #1	0.0000	0.0000	Home	
0004	Cleanout				
0005	End Cleanout	0.0000	0.0000	Home	
0006	End Prog	0.0000	0.0000	Home	
N0004 Pocket Cleanout					
Rough Cuts		: Conventional			
Type		: Collapse			
Stepover		: 0.1250			
Feedrate		: 50.0000 M			
Finish Pass		: Climb			
Amount		: 0.0300			
Feedrate		: 20.0000 M			
Tool Number		: 1			
Surface Height		: 0.0000			
Clearance Height		: 0.1000 INC			
"Rapid to" Depth		: 0.1000 INC			
Depth: Total:		: 1.0000 INC			
per Pass		: 0.2500			
Plunge Rate		: 20.0000 M			
Toggle		Help		Math Help	
F3		F5		F6	
Graph		Teach Mode		Accept	
F8		F9		F10	

Where:

Rough Cuts: Selects type of rough cut. Use **F3-Toggle** or **SPACE** to toggle between Conventional and Climb.

Type: Selects type of cleanout to use. The choices are Collapse, which cleans out the pocket from the outside in, or Expand, which cleans out the pocket from the inside out. You can switch between the two by using the **F3-Toggle** or **SPACE** keys

Stepover: The distance between each step in the pocket cleanout. This value cannot be greater than 50% of the tool diameter.

Feedrate: Speed at which cutter performs rough cuts.

Finish Pass: Selects type of finish pass. Use **F3-Toggle** or **SPACE** to toggle between Conventional, Climb, or None.

Amount: Amount of material to be removed on the finish pass.

Feedrate: Speed at which cutter performs finish pass.

Tool Number: Tool number to be used for the finish pass.

Surface Height: The Z-axis position from where the incremental depth is measured.

Clearance Height: This parameter specifies the Z-axis height to which the tool is retracted before moving to different segments during a pocket cleanout.

'Rapid To' Depth: The depth to which rapid positioning moves will be made to when moving the Z axis downward.

Depth: Total: The total depth of the pocket measured as an incremental depth from the surface height.

per Pass: The depth amount of cut to be taken to reach the total depth. This value must be greater than 0.0 and cannot exceed the total depth.

Plunge Rate: The feedrate at which the Z axis is moved when plunging to a lower depth.

After the cleanout parameters are accepted, a screen similar to the following appears:

Intercon Mill v1.25		Current Part: E_Z_PART.icn		
Operation #	Type	X	End Y	Z
0001	;Demo Program			
0002	Rapid	0.0000	-5.0000	0.1000
0003	Tool #1	0.0000	0.0000	Home
0004	Cleanout	10.0000	0.0000	0.1000
0005	Line	10.0000	0.0000	0.1000
0006	Line	10.0000	10.0000	0.1000
0007	Line	0.0000	10.0000	0.1000
0008	Line	0.0000	0.0000	0.1000
0009	Island start pt	2.5000	2.5000	0.1000
0010	Line	7.5000	2.5000	0.1000
0011	Line	7.5000	7.5000	0.1000
0012	Line	2.5000	7.5000	0.1000
0013	End Cleanout	2.5000	7.5000	0.1000
0014	End Prog	2.5000	7.5000	Home

Select operation to insert...

Island F1	Linear F2	Arc F3
--------------	--------------	-----------

Key points about the Cleanout cycle:

- When creating a pocket the first move in your cleanout cycle **must** be a linear move.
- If the profile contour does not end at the start point, a linear segment will automatically be inserted to close the pocket.
- The last line of the contour will not include a connecting radius to the starting point.

Once you have defined the specifics of your cleanout cycle, the shape of your pocket will be defined through a series of lines and arcs by choosing the **F2-Linear** and **F3-Arc** options in the cleanout cycle.

F1-Island (Island Avoidance) Once you have defined a pocket in the cleanout cycle. There may be areas or islands that you don't want cleaned out. To create an island press **F1-Island**, enter the starting point of the island and then use **F2-Linear** and **F3-Arc** to create the island.

See an example of a completed cleanout backplot below.

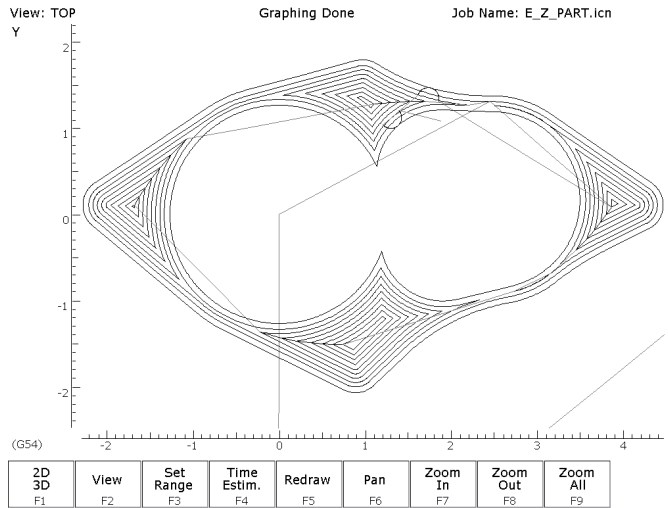

F6 – Other Choosing F6 - Other will display the following operations that may be inserted.

- F1 - Comment** - Enter a comment, up to 35 characters long, which will be displayed in the generated CNC program.
- F2 - Spindle** - Change the actual state of the spindle. Press **F3 - Toggle** or **SPACE** to toggle between CW, CCW, and OFF.
- F3 - Coolant** - Change the actual state of the coolant. Press **F3 - Toggle** or **SPACE** to toggle between FLOOD, MIST, and OFF.
- F4 - Clamp** - Turn the Clamp ON and OFF. Press **F3 - Toggle** or **SPACE** to change the clamp state.
- F5 - Z Home** - Send the Z-axis to its home position.
- F6 - M & G Code** - Enter M & G codes into your Intercon part program. Great care must be taken when using this function, as you could cause unpredictable results in the controller if you accidentally changed positioning modes in your program, or perhaps turning the spindle off during a cut.
- F7 - Rotary** - Insert a rapid rotary move. This operation requires a rotary fourth axis. The fields are identical to the fields in the Linear Mill operation as shown below, but the resulting move is a G0 (Rapid) moving only the rotary axis.

N0140 Move Rotary Axis		
Rotary Axis B		
Degrees	:	25°INC
Minutes	:	10 INC
Seconds	:	10 INC
Decimal Degrees	:	25.1694°INC

F8 - Import DXF - Insert Intercon operations created from objects in DXF files. For more information, refer to the "Importing DXF files" section later in this chapter.

F7 - Cutter Compensation Pressing F7 - Cutter Comp from the Insert Operation screen, will insert a cutter compensation command. Press F3 - Toggle or SPACE to select cutter compensation Left, Right, or Off. Cutter compensation may be used with Linear Mill, Frame Mill, and Rapid Traverse operations. For details on using cutter compensation, see the section “G40, G41, G42 –Cutter Compensation” in Chapter 12.

The Rectangular Pocket, Circular Pocket, and Frame Mill canned cycles perform cutter compensation automatically. If compensation left or right was selected before the canned cycle, it will be turned off.

F9 – Subprograms Intercon subprograms allow you to make additional copies of a programmed contour. The copies may be repeated in the x/y axes, depth repeat, rotated, or even a mirror image of the original. To create a subprogram, first define the operations that will compose the contour. Any type of program operation (rapid, linear mill, arc mill, canned cycle, subprogram, etc.) may be included in the contour. These operations must be programmed at the Z depth at which the first pass will occur. When you are finished doing this, return to the Program Edit Menu. Move to the place in the program where you want to repeat these operations and press the F3 - Insert key. The operations will be performed once before the repeat operation occurs; therefore the operations to compose the contour should be defined at the place in the program where they should occur first.

When you press **F9 - Subpgm** from the Insert Operation screen you will see the Insert Subprogram screen:

Intercon Mill v1.25					Current Part: flange.icn
Operation #	Type	X	End Y	Z	
0001	Header				Select operation to insert...
0002	Tool #1	0.0000	0.0000	Home	
0003	Circ Poc	0.0000	0.0000	0.1000	
0004	Drill BHC	0.8839	-0.8839	0.1000	
0005	Frame	1.2500	1.6625	0.1000	
0006	End Prog	1.2500	1.6625	Home	

Depth Repeat F1	Repeat F2	Mirror F3	Rotate F4
--------------------	--------------	--------------	--------------

You may now select the type of subprogram desired.

Repeat to Depth (F1 in the Insert Subprogram Menu)

Intercon Mill v1.25				Current Part: flange.icn	
Operation #	Type	End X	Y	Z	N0006 Repeat to Depth
0001	Header				Start Block : N0003
0002	Tool #1	0.0000	0.0000	Home	End Block : N0005
0003	Circ Poc	0.0000	0.0000	0.1000	Total Depth : 0.5000 INC
0004	Drill BHC	0.8839	-0.8839	0.1000	Depth Increment : 0.1000 INC
0005	Frame	1.2500	1.6625	0.1000	Clearance Height : 0.1000
0006	Depth Rpt				Plunge Rate : 10.0000
0007	End Prog	1.2500	1.6625	Home	
					Warning!
					Operator must program first pass at depth increment. Plunge must be programmed into this pass.
		Toggle		Help	Math Help
		F3		F5	F6
		Graph		Teach Mode	Accept
		F8		F9	F10

The Repeat to Depth feature is useful for repeating a part contour when the material being machined is too thick to cut in just one pass. The contour formed by these operations may either be a closed contour or an open one. If a non-vertical plunge to the start of the contour is desired, it must be programmed into the contour (a vertical plunge between passes will be provided if one is not programmed).

Total Depth: Indicates how deep the final depth pass is to be. This is a positive value. Note that because the contour has been programmed at a depth of one depth increment below the work piece surface, the final depth assumes that one depth pass has already been performed, and, thus, subtracts one depth increment from the total depth.

Depth Increment: Specifies the distance to drop each time the contour is repeated. This is a positive value that may not exceed the total depth of the operation.

When you have finished entering the required parameters, press **F10 - Accept** to accept them. An operation labeled “Depth Rpt” will be inserted into your program in front of the highlighted operation. You may now edit this operation just as you would edit any other operation (use the cursor keys to highlight the “Depth Rpt” operation, and then press **ENTER**).

* NOTE: If you wish to change the amount of the depth increment per pass after the contour has been programmed, you must also change the Z depth of all the operations inside the contour to correspond to the new increment.

Repeat (F2 in the Insert Subprogram Menu)

The Repeat feature is useful for repeating a part contour one or more times along a straight line in the XY plane. The contour formed by these operations may either be closed or open. If a rotary axis is enabled, this operation can also be used for repeating such a contour one or more times over a specified rotary increment.

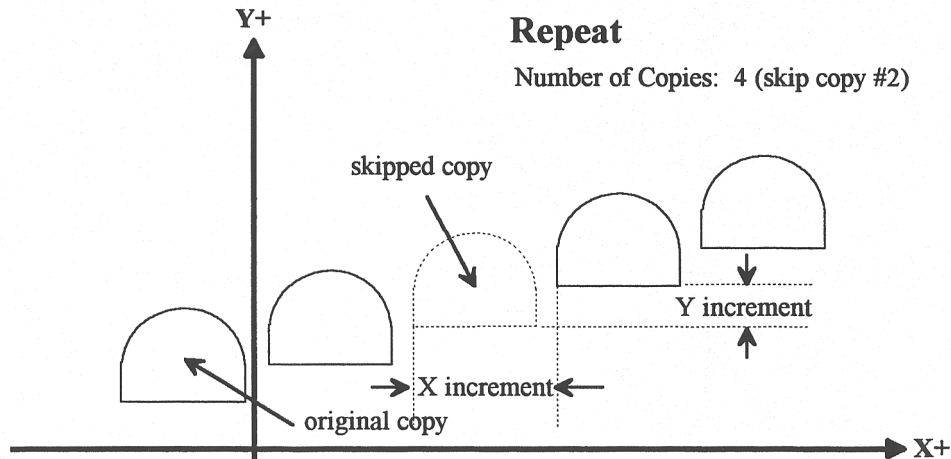

Increment: Specifies the X and Y distances between the start points of each copy of the contour.

Rotary Increment: Specifies the rotary incremental amount to move between each copy of the contour. Note: This field will appear only if a rotary axis is enabled.

Number of Copies: The number of times to repeat the contour.

Skip List: List of copies that are skipped. Enter the number or numbers of the copies that you wish to skip. In the example below will skip copy # 2.

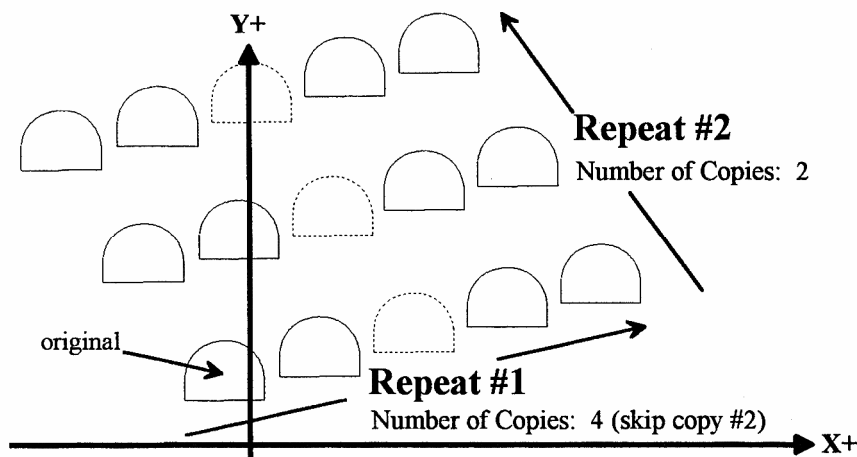

* NOTE: An array of repeats may be accomplished by doing a repeat of a repeat.

Mirror (F3 in the Insert Subprogram Menu)

The Mirror feature is useful for reflecting a part contour over a line. The contour formed by these operations may either be closed or open.

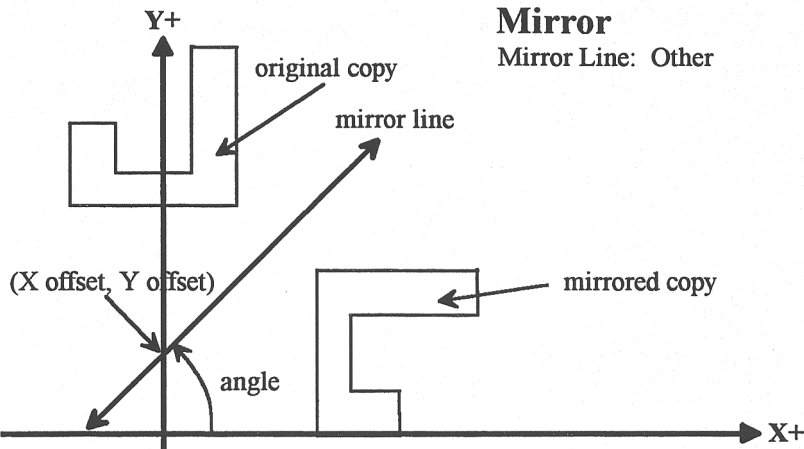

Mirror Line: Specifies the type of mirror line to use. Choices are Horizontal, Vertical and Other (user-defined).

X Offset: Specifies the X coordinate on the Mirror Line. This field will not be visible for a horizontal mirror line.

Y Offset: Specifies the Y coordinate on the Mirror Line. This field will not be visible for a vertical mirror line.

Angle: Specifies the angle (from the three o'clock position) of the Mirror Line. This field will only be visible for a user-defined mirror line and is used in conjunction with the X Offset and Y Offset fields to define the mirror line.

Rotate (F4 in the Insert Subprogram Menu)

The Rotate feature is useful for rotating a part contour multiple times around a given point. The contour formed by these operations may either be closed or open.

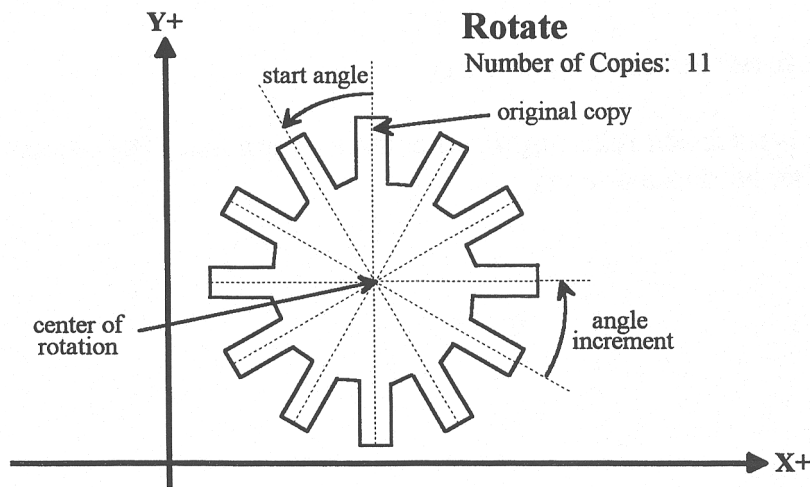

Center: The XY location of the center of rotation.

Start Angle: The angle from the original copy at which the first copy will be placed. A positive angle indicates a counterclockwise rotation, while a negative angle indicates a clockwise rotation.

Angle Increment: The angle at which each copy after the first will be placed from the first copy. A positive angle indicates a counterclockwise, while a negative angle indicates a clockwise rotation. Must have a value larger than 1 in the number of copies.

Number of Copies: The number of times to rotate the contour.

End Angle: The angle at which the final rotated copy will start, **not the angle at which it will end**. A positive angle indicates a counterclockwise rotation, while a negative angle indicates a clockwise rotation.

Skip List: List of copies that are skipped. Enter the number or numbers of the copies that you wish to skip.

NOTE: The user may enter the Start Angle, the Number of Copies, and either the Angle Increment or the End Angle value, and Intercon will compute the rest.

Graphics

Intercon features three-dimensional previews of the tool path to be followed when milling the part. You may choose to display your project in one of two formats: a three-plane display, where the project is shown in each of the XY-, ZX-, and YZ-planes; or an isometric display, which depicts the project three-dimensionally from an observer's point of view. To view the graphics, press **F8 - Graph** from the Main Menu or from any Operation Edit screen.

The format of the display will be similar to the following:

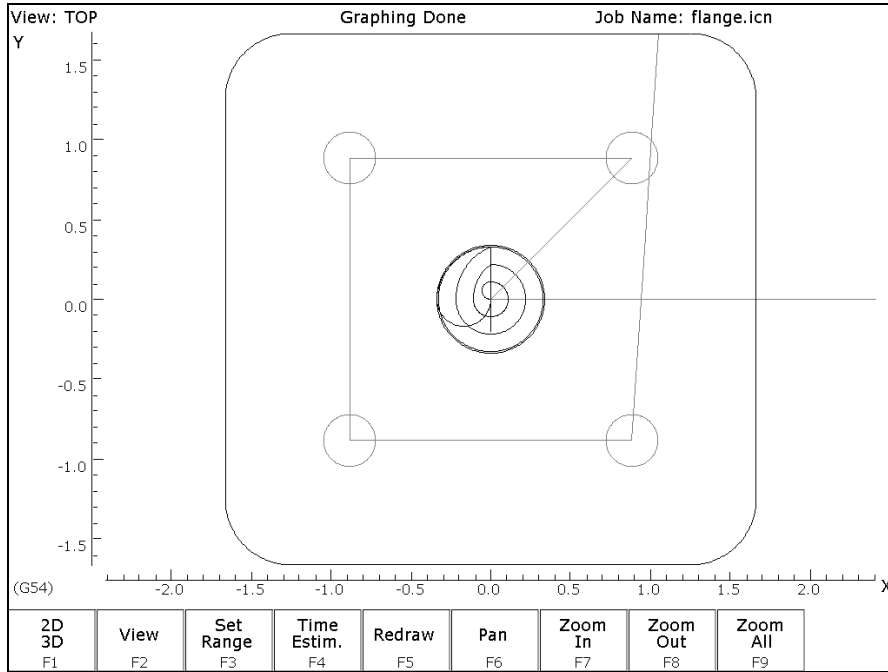

The display will consist of arcs and/or lines that make up the tool path followed. Rapid (G0) moves will appear in Red, linear (G1) and arc (G2, G3) moves will be Yellow, and compensated pass will appear in grey. Canned cycle operations (except the facing cycle) will also display a gray.

F1 - 2D/3D Pressing **F1 - 2D/3D** selects the format of the project display. This may take the form of the three-plane display (2D) or the isometric display (3D).

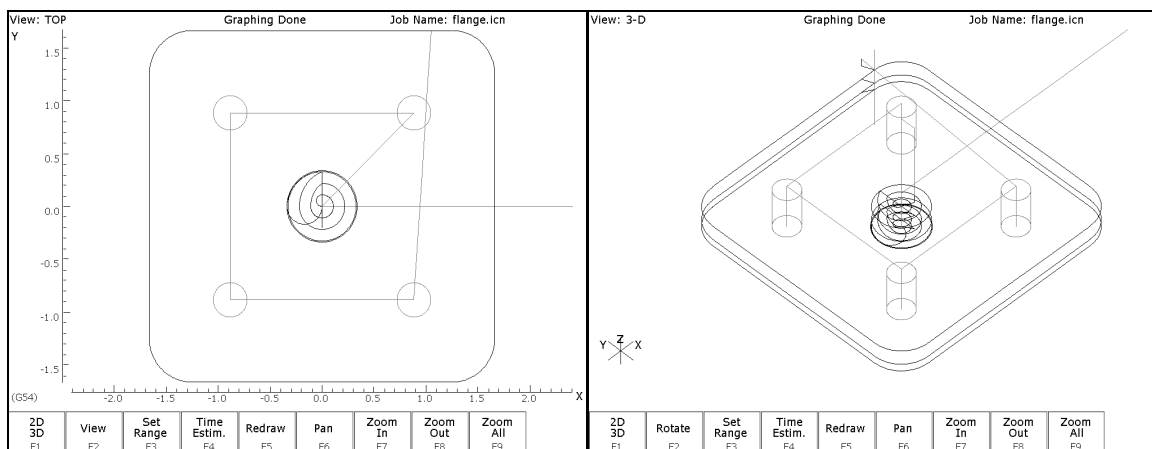

Three-plane (2D)

Isometric (3D)

F2 – View/Rotate In three-plane (2D) view, **F2 - View** switches the point of view to a different plane. In isometric, (3D) view, **F2 - Rotate** enables the arrow keys to rotate the figure. The arrow keys actually rotate a larger version of the YZX axes figure that shows the orientation in which the part will be redrawn. Press **F2 - Rotate** to redraw without leaving rotation mode. If you press Enter or **F5 - Redraw** after rotating the axes, the display of the axes will disappear. To rotate to a different angle you will have to press **F2 - Rotate** again. Press Esc to cancel rotation.

F3 – Set Range Press **F3 – Set Range** to specify the range of operations to draw. You will be prompted for a start block and an end block.

F4 – Time Estimate Press **F4 - Time Estim.** to hide or display the time estimate in the upper left-hand portion of the screen.

F5 – Redraw Pressing the **F5 - Redraw** key will cause the simulation to start again from the first operation (Redraw).

F6 – Pan When using the pan feature, the project can be centered to the crosshairs in the display windows of the three-plane display, or rotated around the center of the isometric display screen. To enter pan mode, simply press the **F6 - Pan** key or press one of the **Arrow** keys. A set of crosshairs will appear. Adjust the center of the crosshairs to the new desired center. Press **Enter, F5 – Redraw, F6 - Pan** to redraw the part with the new screen center point.

F7, F8 & F9: Zoom In, Zoom Out & Zoom All The project can also be viewed in an enlarged or reduced state by pressing the **F7 - Zoom In** or **F8 - Zoom Out** keys to activate Zoom In and Zoom Out respectively. Pressing **F9 - Zoom All** redraws the project at its original size. Use the arrow keys to select the new screen center before zooming in or out.

Number keys and Space bar – Feed Rate Override & Hold If no jog panel is attached (or “Keyboard” has been selected as the jog panel type) the number keys 1 – 9 and 0 choose feed rate overrides 10% - 90% and 100%, respectively. 1 is 10%, 9 is 90%, and 0 is 100 %. If there is a jog panel attached you can use the feedrate knob to adjust the speed as well. The space bar toggles feed hold on and off.

Accelerated Graphics Backplot

Accelerated Graphics Backplot is a new tool path graphics display that takes advantage of the latest video graphics technology. This option is enabled by setting Parameter 260 to 1 (See Chapter 14 Configuration). Under Accelerated Graphics Backplot, the operation of the user interface is slightly different from the regular Graphing described above.

F1 - Pan/Rotate Press this key to change the behavior of the keyboard arrow keys. Normally, they will pan (scroll) around the drawing, but after pressing this key the arrow keys will control rotation instead. When in rotation mode, an axis indicator is drawn to mark the center of rotation.

F2 - View Press this key to change the planar view of your part. The view is indicated by TOP, RIGHT, or FRONT shown at the top of the screen.

F3 - Set Range Press this key to select which blocks of G-code to display. Only blocks that fall within the range you specify will be drawn.

- F4 - Dimension Menu** Press this key to access a sub-menu of options:
- F1 – Prev Line:** Press this to walk forward to the next G-code line and graphically highlight it. If this G-code line contains movement, the Start and End points will be displayed at the bottom of the screen.
 - F2 – Next Line:** Press this to walk backward to the previous G-code line and graphically highlight it. If this G-code line contains movement, the Start and End points will be displayed at the bottom of the screen.
 - F3 – Go To Line:** Press this key to graphically highlight a particular G-code line whose line number you specify. If this G-code line contains movement, the Start and End points will be displayed.
 - F4 – Measure:** Use this feature to measure between any 2 selected points. To do this, use a mouse to move the pointer over the first point and then press **F4 – Measure** to anchor the first point. Then use the mouse to move the pointer to the second point. As you move the mouse towards the second point, you will notice an Offset and Measurement display changing dynamically as you move the mouse. Also you may notice some “snap to” effects as you move the pointer close to start and end points of entities that make up your program.
- F5 - Redraw** Press this key to redraw the part slowly, which can be useful for visualizing the movements the machine will make. While the display is being redrawn, you can use the feedrate override knob to adjust the rate at which it is being drawn. If you don't have a feedrate override knob, the + and - keys can be used to adjust the rate. Pressing F5 again will cancel this mode.
- F6 - Hide Rapids** Press this key to hide rapid movements. Press it again to show them.
- F7 - Zoom In** Press these keys to zoom into the part relative to the center of the screen.
- F8 - Zoom Out** Press these keys to zoom away from the part relative to the center of the screen.
- F9 - Zoom All** Press this key to fit the entire part inside the screen.
- F10 - Show Tools** Press this key to show the tools menu, which allows you to highlight movements of certain tools. Press this key again to hide the tools menu.
- Spacebar - Measure** Press this key to take a measurement between two points. In a 2D view, this measurement will be a 2D measurement. In a 3D view, it will be a 3D measurement (and the measurement will only be valid if the crosshairs are snapped to a line of the tool path).

***Note:** If you have a mouse or touch screen attached to your device, you can use that to control the graphing window. Holding the left mouse button allows you to drag the part across the screen, while the right mouse button controls rotation of the part. Spinning the mouse wheel (or holding both left and right buttons) zooms in and out. Double clicking on a feedrate movement will center the camera on that movement (which is very useful) and also tells you the length of that movement. For touchscreen operation, use the F1 key to switch between Pan and Rotate modes.

Math Help

Intercon provides a math assistance function to solve the trigonometric problems common in part drawings. To enter Math Help, press **F6 - Math Help** from any Edit Operation screen. The first time that you invoke Math Help, the following screen appears which shows all available *solvers*:

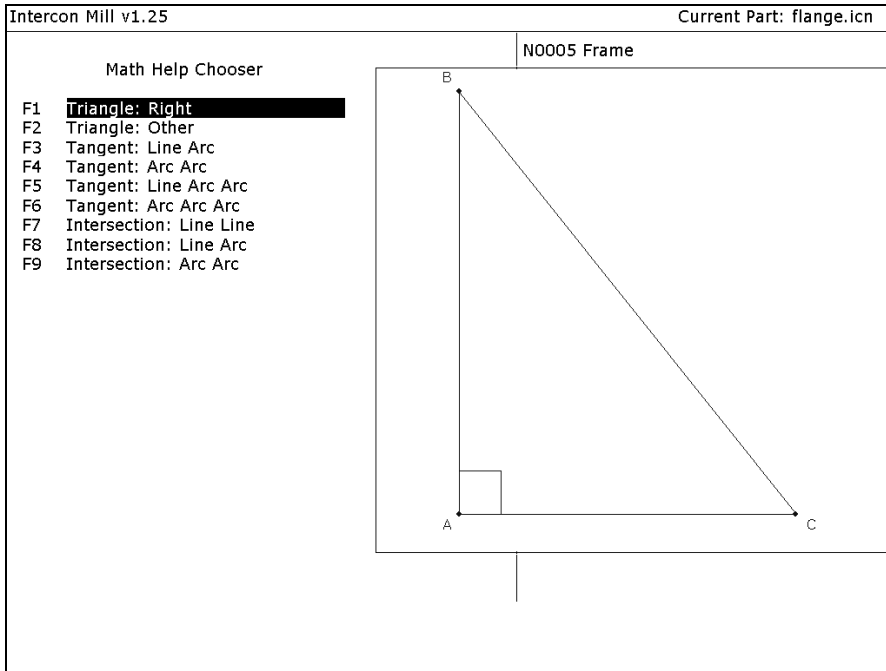

The figures on the right are a graphical representation of the highlighted solver on the left. Pressing **ENTER** key will display another menu that has various fields particular to the type of problem that is being solved. The graphic below displays the Right Triangle Calculator menu. The options that are available on the function keys are the same for every type of math help solver and perform the following operations:

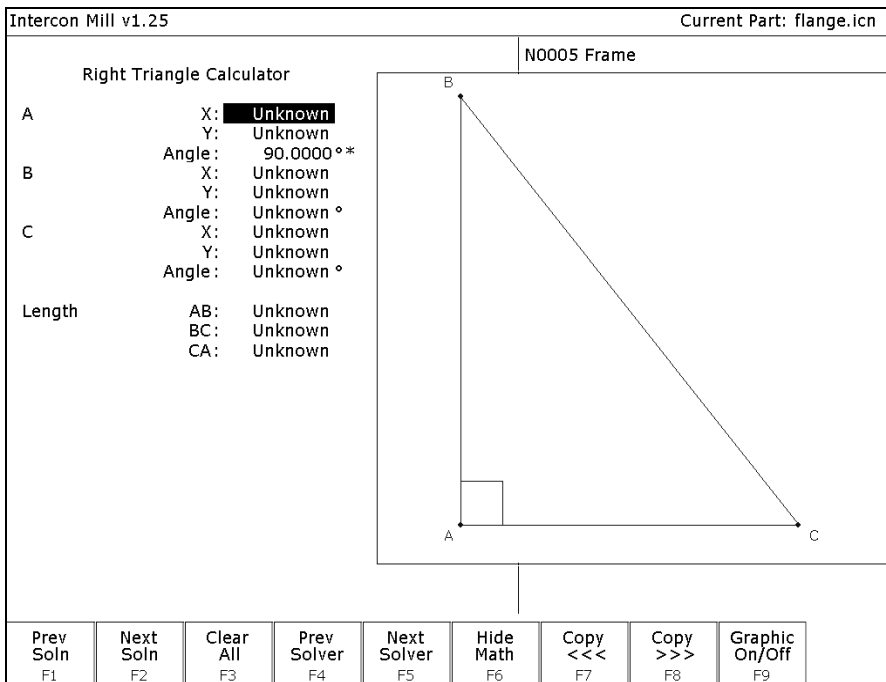

F1 – Prev Soln (Previous Solution)

F2 – Next Soln (Next Solution) The **Prev Soln** and **Next Soln** options will cycle backward and forward, respectively, through the available solution sets for math solvers that may have multiple solutions. A status line near the bottom left of the screen appears once a valid solution has been found. The solution status line indicates the total number of solutions and the solution number that is currently represented by the graphic display on the right. For example, in an Arc Tangent Arcs math help, the display solution status may be “- Solution 1 of 8 -“. In this case, the **Prev Soln** and **Next Soln** can be used to cycle through all eight of the solutions.

F3 – Clear All The Clear All option removes all solutions. It sets all fields for a particular solver to **UNKNOWN**.

F4 – Prev Solver

F5 – Next Solver The **Prev Solver** and **Next Solver** options cycle backward and forward, respectively, through the various math help solvers. These options are shortcuts which have the same effect as pressing **ESC** to reach the main math help menu, navigating to the previous or next math help option, and then pressing **ENTER**.

F6 – Hide Math The **F6 - Hide Math** option exits math help mode and returns to the operation edit menu. Pressing **F6 - Math Help** to invoke Math Help again will restore Math Help exactly as you left it. After copying values from Math Help, you can press **F6 - Hide Math** to hide Math Help, and then hit **F10 - Accept** to accept the values entered.

F7 – Copy <<<

F8 – Copy >>> The **F8 - Copy <<<** option will move the value from the selected edit operation field into the selected math help menu field and the **Copy >>>** operation will move the value from the selected math help menu field into the selected edit operation field. For both options, the selected fields in the math help menu and the operation edit menu are advanced. Only when the graphics display is off will the Copy operations actually copy values and advance field selections.

The currently selected fields have either a box drawn around them or are highlighted depending upon which menu is active. The active menu, which is either the math operation menu on the left hand side or the operation edit menu on the right hand side, depicts the selected field by highlighting the entire field. The non-active menu displays the active field with a box drawn around it. Use the arrow keys to select fields as described below.

F9 – Graphic On/Off The **F9 - Graphic On/Off** option will toggle the graphical representation of the math help menu on the display.

↑ ↓ ← → (Arrow Keys) – Select Fields

The **LEFT** and **RIGHT** arrow keys are used to navigate between the math menu and the edit menu. The **UP** and **DOWN** arrow keys are used to navigate within a menu. To choose fields for the “Copy” option, above, use the **UP** and **DOWN** arrow keys to highlight the desired field in the menu and use the **LEFT** or **RIGHT** arrow keys to switch menus.

Other features common to all Math Help operations

In some math help operations, there will be an asterisk “*” character that appears immediately to the right of a field. This character marks the field as a “given” field, which means that the value of this field will be held constant in the process of solving the math equations.

F1 –Triangle: Right

F2 –Triangle: Other

Intercon Mill v1.25 Current Part: flange.icn

N0005 Frame

Triangle Calculator

A X: **Unknown**
Y: Unknown
Angle: Unknown °

B X: Unknown
Y: Unknown
Angle: Unknown °

C X: Unknown
Y: Unknown
Angle: Unknown °

Length AB: Unknown
BC: Unknown
CA: Unknown

Prev Soln F1	Next Soln F2	Clear All F3	Prev Solver F4	Next Solver F5	Hide Math F6	Copy <<< F7	Copy >>> F8	Graphic On/Off F9
-----------------	-----------------	-----------------	-------------------	-------------------	-----------------	----------------	----------------	----------------------

The screen will show **UNKNOWN** if the value of each parameter is not known. Math Help waits for known values to be entered, where:

Point a, b, or c is the coordinate value for each corner of the triangle.

Angle A, B, or C is the angle at each point of the triangle.

Length of values are the distances between the points indicated.

Continue adding all the known parameters. Select parameters using the arrow soft keys. When Math Help solves the remaining unknown values, the screen will display them.

F3 – Tangent: Line Arc

Intercon Mill v1.25 Current Part: flange.icn

N0005 Frame

Line Tangent Arc

Circle	X:	0.0000
	Y:	0.0000
	Radius:	1.0000
Line	X:	4.0000
	Y:	0.0000
Tangent	X:	0.2500
	Y:	-0.9682

- Solution 1 of 2 -

Prev Soln F1	Next Soln F2	Clear All F3	Prev Solver F4	Next Solver F5	Hide Math F6	Copy <<< F7	Copy >>> F8	Graphic On/Off F9
-----------------	-----------------	-----------------	-------------------	-------------------	-----------------	----------------	----------------	----------------------

Given the center (C1) the radius of an arc, and 1 point (LP) on a line, find the lines tangent to the arc (defined by the tangent point (T1)).

You must enter the X and Y coordinates for the circle's center point, the circle's radius, and the X and Y coordinates for a point on the line.

F4 – Tangent: Arc Arc

Intercon Mill v1.25 Current Part: flange.icn

N0005 Frame

Arc Tangent Arc

Circle 1	X:	0.0000
	Y:	0.0000
	Radius:	1.0000
Circle 2	X:	0.0000
	Y:	0.5000
	Radius:	0.5000
Tangent	X:	0.0000
	Y:	1.0000

- Solution 1 of 1 -

Prev Soln F1	Next Soln F2	Clear All F3	Prev Solver F4	Next Solver F5	Hide Math F6	Copy <<< F7	Copy >>> F8	Graphic On/Off F9
-----------------	-----------------	-----------------	-------------------	-------------------	-----------------	----------------	----------------	----------------------

Given the center points (C1 and C2) and radii (R1 and R2) of two arcs, find the point (T) at which they are tangent.

You must enter the X and Y coordinates for the first circle's center point, the radius of the first circle, the X and Y coordinates for the second circle's center point, and the second circle's radius.

F5 – Tangent: Line Arc Arc

Intercon Mill v1.25 Current Part: flange.icn

N0005 Frame

Line Tangent Arcs		
Circle 1	X:	0.0000
	Y:	0.0000
	Radius :	1.0000
Circle 2	X:	4.0000
	Y:	0.0000
	Radius :	1.5000
Tangent 1	X:	-0.1250
	Y:	0.9922
Tangent 2	X:	3.8125
	Y:	1.4882

- Solution 1 of 4 -

Prev Soln F1	Next Soln F2	Clear All F3	Prev Solver F4	Next Solver F5	Hide Math F6	Copy <<< F7	Copy >>> F8	Graphic On/Off F9
-----------------	-----------------	-----------------	-------------------	-------------------	-----------------	----------------	----------------	----------------------

Given the center points (C1 and C2) and radii (R1 and R2) of two arcs, find the lines (defined by T1 – T2) tangent to both arcs.

You must enter the X and Y coordinates for the first circle's center point, the radius of the first circle, the X and Y coordinates for the second circle's center point, and the second circle's radius.

F6 – Tangent: Arc Arc Arc

Intercon Mill v1.25 Current Part: flange.icn

N0005 Frame

Arc Tangent Arcs		
Circle 1	X:	-2.0000
	Y:	0.0000
	Radius :	1.0000
Circle 2	X:	4.0000
	Y:	0.0000
	Radius :	2.0000
Circle 3	X:	0.2500
	Y:	-3.3072
	Radius :	3.0000
Tangent 1	X:	-1.4375
	Y:	-0.8268
Tangent 2	X:	2.5000
	Y:	-1.3229

- Solution 1 of 4 -

Prev Soln F1	Next Soln F2	Clear All F3	Prev Solver F4	Next Solver F5	Hide Math F6	Copy <<< F7	Copy >>> F8	Graphic On/Off F9
-----------------	-----------------	-----------------	-------------------	-------------------	-----------------	----------------	----------------	----------------------

Given the center points (C1 and C2) and radii (R1 and R2) of two arcs and the radius of a third arc, find the center point of the third arc and the tangent points (T1 and T2).

You must enter the radius of the tangent arc, the X and Y coordinates for the first circle's center point, the radius of the first circle, the X and Y coordinates for the second circle's center point, and the second circle's radius.

F7 – Intersection: Line Line

Intercon Mill v1.25 Current Part: flange.icn

N0005 Frame

Line Intersection Line

Line 1 X1: 0.0000 *
 Y1: 0.0000 *
 X2: 5.0000 *
 Y2: 5.0000 *
 Angle: 45.0000

Line 2 X1: 0.0000 *
 Y1: 5.0000 *
 X2: 8.0000 *
 Y2: -1.0000 *
 Angle: **323.1301**

Inter-
section X: 2.8571
 Y: 2.8571

* Given (Space to Toggle)

- Solution 1 of 1 -

Prev Soln F1	Next Soln F2	Clear All F3	Prev Solver F4	Next Solver F5	Hide Math F6	Copy <<< F7	Copy >>> F8	Graphic On/Off F9
-----------------	-----------------	-----------------	-------------------	-------------------	-----------------	----------------	----------------	----------------------

You must enter the X and Y coordinates for 1 point on each line, and also one of the following:

- * the X and Y coordinates for a second point
- * the X coordinate for a second point and the angle from horizontal
- * the Y coordinate for a second point and the angle from horizontal
- * the angle from horizontal only

F8 – Intersection: Line Arc

Intercon Mill v1.25 Current Part: flange.icn

N0005 Frame

Line Intersection Arc

Circle X: 0.0000
 Y: 0.0000
 Radius: 1.0000

Line X1: -2.0000 *
 Y1: -2.0000 *
 X2: 2.0000 *
 Y2: 0.3094 *
 Angle: **30.0000** *

Int. 1 X1: 0.9560
 Y1: -0.2933

Int. 2 X2: -0.2240
 Y2: -0.9746

* Given (Space to Toggle)

- Solution 1 of 1 -

Prev Soln F1	Next Soln F2	Clear All F3	Prev Solver F4	Next Solver F5	Hide Math F6	Copy <<< F7	Copy >>> F8	Graphic On/Off F9
-----------------	-----------------	-----------------	-------------------	-------------------	-----------------	----------------	----------------	----------------------

Given the center (C1) and radius (R) of an arc, 1 point (P1) and either a second point (P2) or one coordinate (P2 X or Y) and the angle from horizontal, find the intersection point(s) (I1 and I2).

You must enter the X and Y coordinates for the circle's center point, the circle's radius, the X and Y coordinates for one point on the line, and one of the following:

- * the X and Y coordinates of a second point on the line
- * the X coordinate of a second point and the angle from horizontal
- * the Y coordinate of a second point and the angle from horizontal

F9 – Intersection: Arc Arc

Intercon Mill v1.25 Current Part: flange.icn

Arc Intersection Arc		N0005 Frame									
Circle 1	X: 0.0000 Y: 0.0000 Radius: 3.0000										
Circle 2	X: 4.0000 Y: 0.0000 Radius: 4.0000										
Int. 1	X1: 1.1250 Y1: -2.7811										
Int. 2	X2: 1.1250 Y2: 2.7811										
- Solution 1 of 1 -											
<table border="1" style="width: 100%; font-size: x-small; text-align: center;"> <tr> <td>Prev Soln F1</td> <td>Next Soln F2</td> <td>Clear All F3</td> <td>Prev Solver F4</td> <td>Next Solver F5</td> <td>Hide Math F6</td> <td>Copy <<< F7</td> <td>Copy >>> F8</td> <td>Graphic On/Off F9</td> </tr> </table>			Prev Soln F1	Next Soln F2	Clear All F3	Prev Solver F4	Next Solver F5	Hide Math F6	Copy <<< F7	Copy >>> F8	Graphic On/Off F9
Prev Soln F1	Next Soln F2		Clear All F3	Prev Solver F4	Next Solver F5	Hide Math F6	Copy <<< F7	Copy >>> F8	Graphic On/Off F9		

Given the center points (C1 and C2) and the radii (R1 and R2) of two arcs, find the intersection point(s) (I1 and I2) of the arcs.

You must enter the X and Y coordinates for the first circle's center point, the radius of the first circle, the X and Y coordinates for the second circle's center point, and the second circle's radius.

Importing DXF files (Optional)

Intercon allows you to convert geometry in DXF files to Intercon operations. To insert operations from a DXF file press **F6 – Other** then **F8 - Import DXF**. If no DXF files have been loaded yet, the Intercon load file menu will appear. From here you may select the DXF file you wish to load. By default, Intercon expects DXF files to reside in the **c:\cncm\ncfiles** directory. To change the default directory used by the Intercon load menu when loading DXF files, see the “User Specified Paths” section of Chapter 14.

Intercon reads DXF files up to and including version R14. At this time, only *point*, *line*, *arc*, *circle*, *polyline* and *lwpolyline* entities can be used to create Intercon operations. All other entities such as *text* must be converted to lines and arcs for them to appear in the Intercon Import DXF menu.

After a DXF file has been loaded, the Set zero reference menu appears.

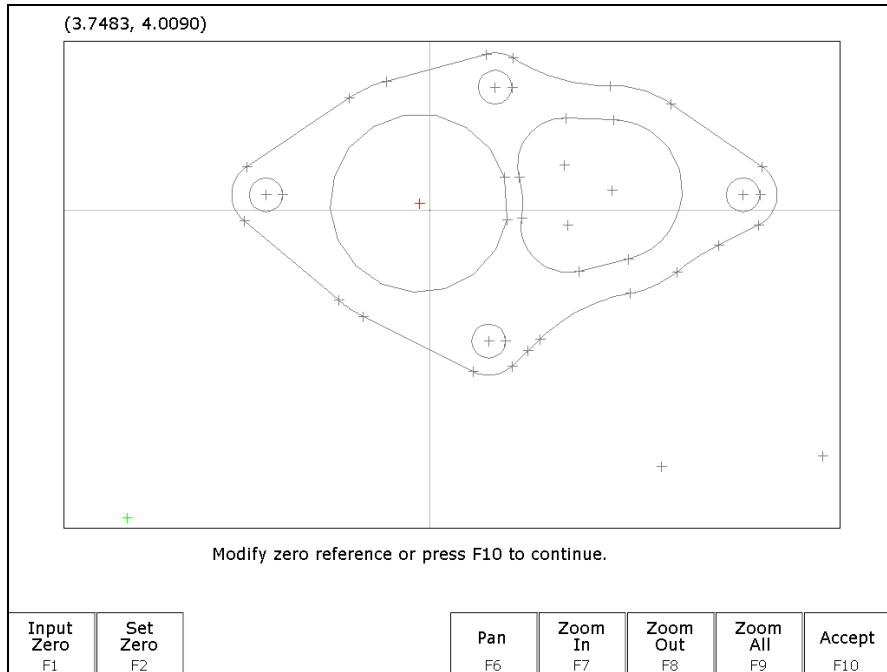

This menu allows you to change the absolute zero reference of the DXF file. The current zero reference appears as a green cross. All other points appear as gray crosses. A new zero reference may be defined by a combination the following methods:

- Press **F1 - Input Zero** to enter the coordinates of the new zero reference.
- Move the crosshairs with the arrow keys to highlight a point (represented by a gray cross) and when the crosshairs are close to a gray cross it will change red. Press **F2 - Set Zero** to set the zero reference to the position of that point.

When satisfied with the current location of the zero reference, press **F10 - Accept**. The zero reference may be changed multiple times before pressing **F10 - Accept**.

After the zero reference is set the Select Intercon operation menu appears.

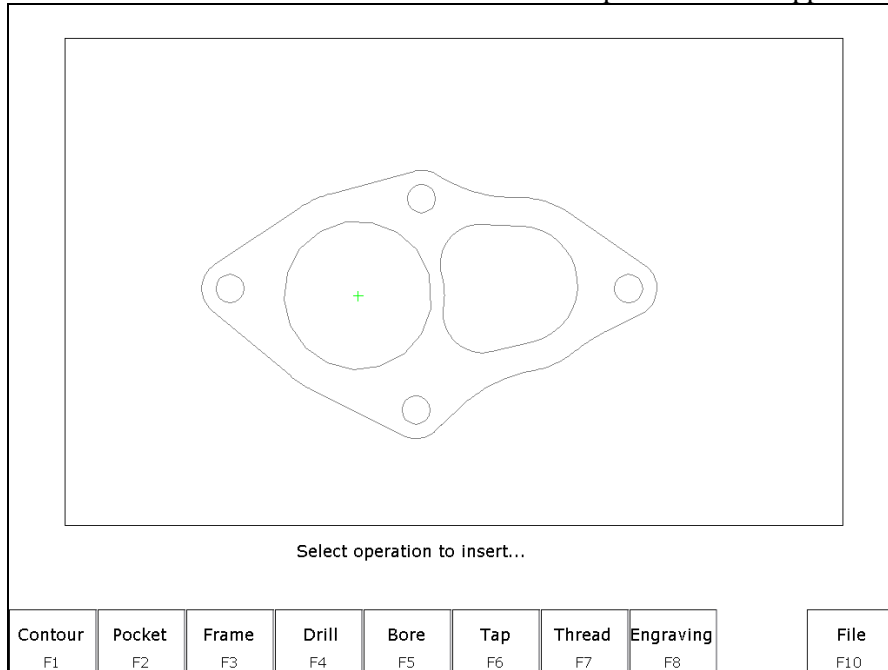

This menu allows you to select the type of Intercon operation you wish to create using geometry from the DXF file.

F1 – Contour Convert one or more connected lines and/or arcs to linear and arc operations.

F2 – Pocket Convert a chain of lines and/or arcs to one of the Intercon pocket operations. The type of pocket depends on the geometry of the selected chain. A chain of arcs will be converted to a circular pocket if all arcs have the same center point and radius. A chain of four lines forming a rectangle will be converted to a rectangular pocket. All other chains will be converted into a cleanout operation.

F3 – Frame Create a frame operation that surrounds a chain of lines and/or arcs. The height, width and center of the chain are used to define the frame.

F4 – Drill Convert one or more points to a drilling operation.

F5 – Bore Convert one or more points to a boring operation.

F6 – Tap Convert one or more points to a tapping operation.

F7 – Thread Convert one or more points to a threading operation.

F8 – Engrave (Optional) Converts the entire file to engraving operations. Choosing this option displays the engraving menu. Set the options as desired for the engraving. Surface Height is the height of the surface to be engraved. Clearance Height is the height that the engraving tool will move up to clear the surface. Depth is the depth of the engraving. Set the Plunge Rate and Feedrate appropriately for the tool and material.

F10 – File Pressing **F10 - File** displays the following options:

F1 – Load Load a new DXF file.

F2 - Zero Change the current zero reference.

F3 - Gap Modify the current gap tolerance. Two lines or arcs are connected if the distance between their end points is less than the gap tolerance.

Selecting DXF geometry

After selecting an operation to from the Select Intercon operation menu, one of two menus appears. Contour, pocket and frame operations display the Select Chain menu and Drill, Bore, Tap and Thread operations display the Select Point menu. These menus allow you to select the geometry you wish to use to create the specified Intercon operation(s).

Select Chain menu

This menu allows you to select a chain of one or more lines and/or arcs. To select a chain, highlight the first line or arc with the crosshairs. Press either **F2 - Single** to accept only that object or press **F3 - Chain** to accept that object and create a chain of lines and arcs connected to that entity. When satisfied with the selected chain, press **F10 - Done** to edit the values for the chosen Intercon operation.

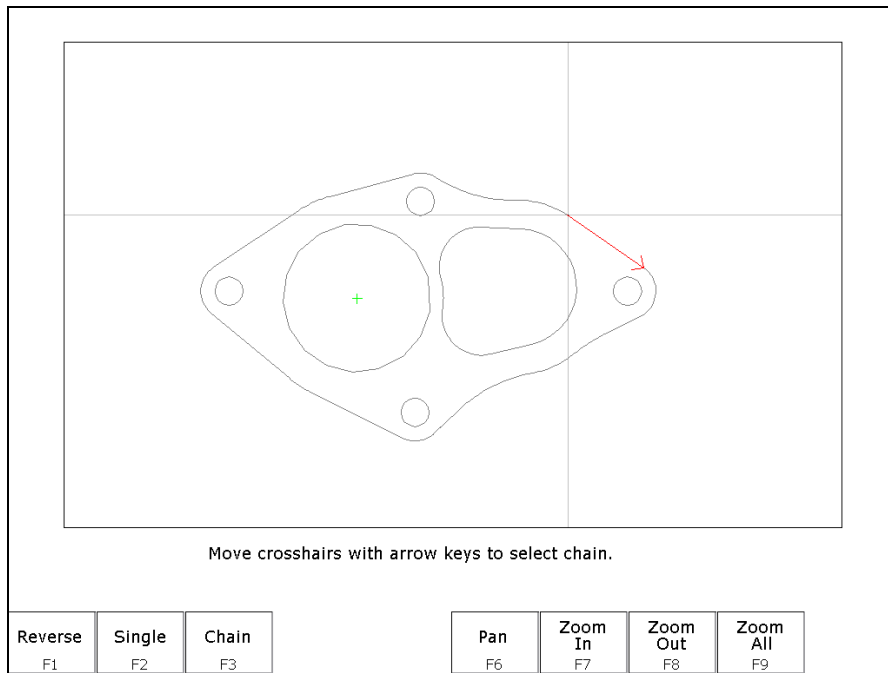

↑ ↓ ← → (Arrow Keys) – Move crosshairs **Use the arrow keys to move the crosshairs.**

F1 – Reverse When a line or arc is highlighted, an arrow appears indicating the direction of the object. Contour operations use this direction when cutting lines and arcs. To reverse the direction of the highlighted line or arc, press **F1 - Reverse**.

F2 – Single Select the currently highlighted line or arc.

F3 – Chain Select the currently highlighted line or arc and create a chain of connected lines or arcs in the direction of this selected object. Chaining will stop if there are no more connected, unselected lines or arcs, or the chain connects to the first object in the chain, or a branch point occurs. A branch point occurs when the last object in the chain is connected to more than one unselected lines or arcs. When this situation occurs, highlight the desired unselected line or arc that connects to the last object in the chain and press **F3 - Chain** to continue chaining.

F5 – Undo Unselect the last line or arc in the chain.

F6 – Pan Set the plot center to the center of the crosshairs.

F7, F8 & F9 - Zoom In, Zoom Out & Zoom All **F7 - Zoom In** and **F8 - Zoom Out**, set the center of the plot to the center of the crosshairs and Zoom In and Zoom Out respectively. **F9 - Zoom All** redraws the part with its original scale.

F10 – Done Accepts the selected chain and proceeds to the Intercon operation edit menu. The operation edit menu allows you to enter values for fields such as feedrate and plunge rate. These values are copied to the rest of the lines and arcs in the chain where applicable.

Intercon Mill v1.25 Current Part: flange.icn

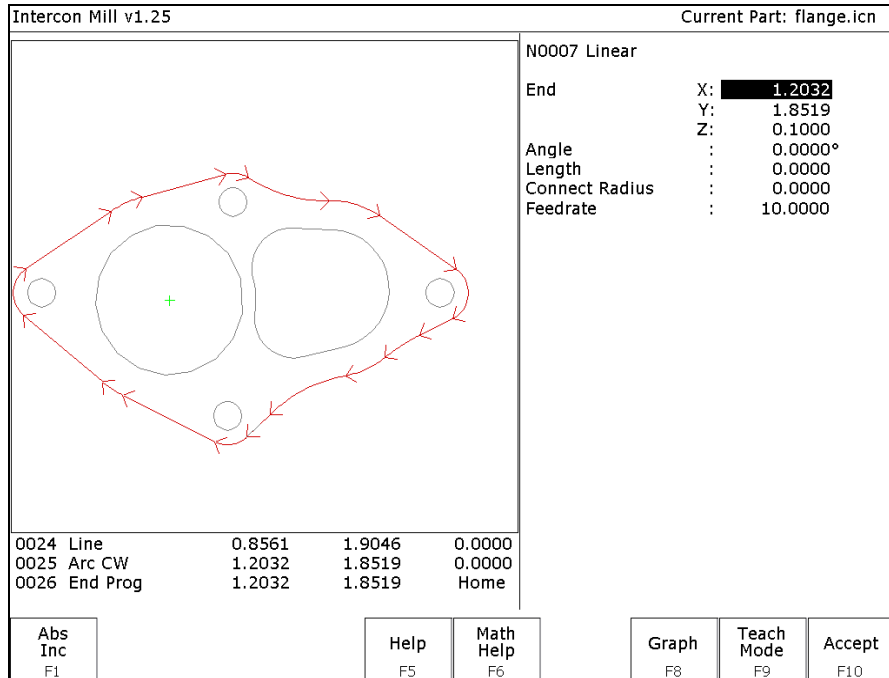

N0007 Linear			
End	X:	1.2032	
	Y:	1.8519	
	Z:	0.1000	
Angle	:	0.0000°	
Length	:	0.0000	
Connect Radius	:	0.0000	
Feedrate	:	10.0000	

0024	Line	0.8561	1.9046	0.0000
0025	Arc CW	1.2032	1.8519	0.0000
0026	End Prog	1.2032	1.8519	Home

Abs Inc F1	Help F5	Math Help F6	Graph F8	Teach Mode F9	Accept F10
---------------	------------	-----------------	-------------	------------------	---------------

The keys **F1 - Reverse**, **F2 - Single** and **F3 - Chain** only appear when a line or arc is highlighted. The keys **F5 - Undo** and **F10 - Done** only appear when one or more objects has been selected with **F2 - Single** or **F3 - Chain**.

Select Point menu

This menu allows you to select one or more points to be converted into Intercon Drilling/Threading operations. In this menu, all selectable points are displayed as gray crosses. Selectable points include point entities, line/arc endpoints and arc/circle center points. To select a point, position the crosshairs over the desired point until the cross turns red and press **F2 - Single** to accept the point. More points can be selected by highlighting them with the crosshairs and pressing **F2 - Single**. **F1 - Window** can be used to select all points within a specified window. When satisfied with the selected point(s), press **F10 - Done** to edit the Intercon operation parameters.

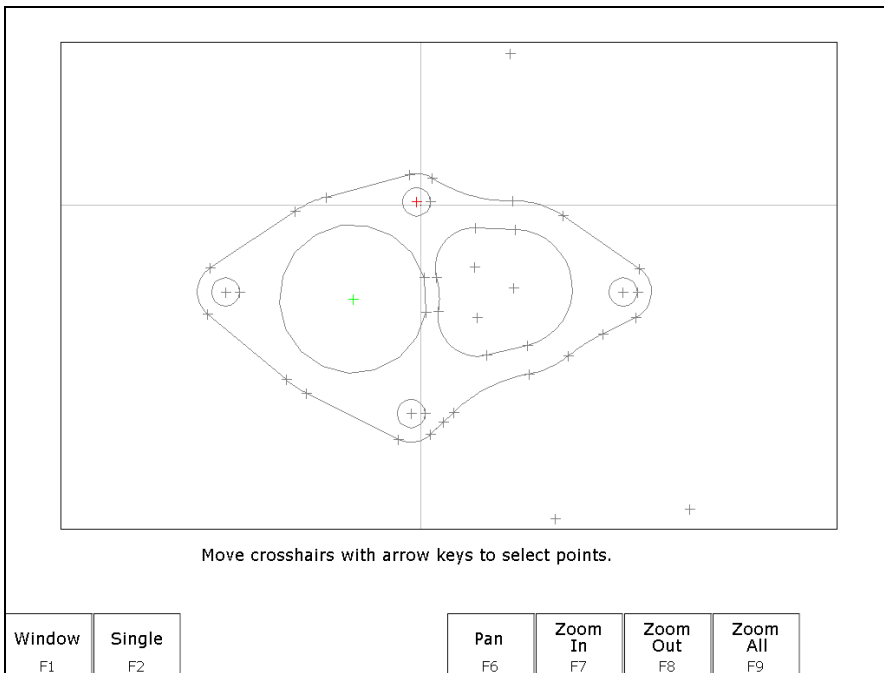

↑ ↓ ← → (Arrow Keys) – Move crosshairs **Press the arrow keys to move the crosshairs.**

F1 – Window This key allows you to select all points within a specified box. Press **F1 - Window** once to set the first corner of the box. Move the crosshairs to the desired location for the opposite corner of the box and press **F1 - Window**. All points within the box are selected.

F2 – Single Accept the currently highlighted point.

F5 – Undo Unselect the last selected point.

F6, F7, F8 & F9 – Pan, Zoom In, Zoom Out & Zoom All These keys perform the same operations they do in the Select Chain menu.

F10 – Done Accepts the selected points and proceeds to the Intercon operation edit menu. The operation edit menu allows you to enter values for fields such as plunge rate and depth. These values are copied to the rest of the selected operations where applicable.

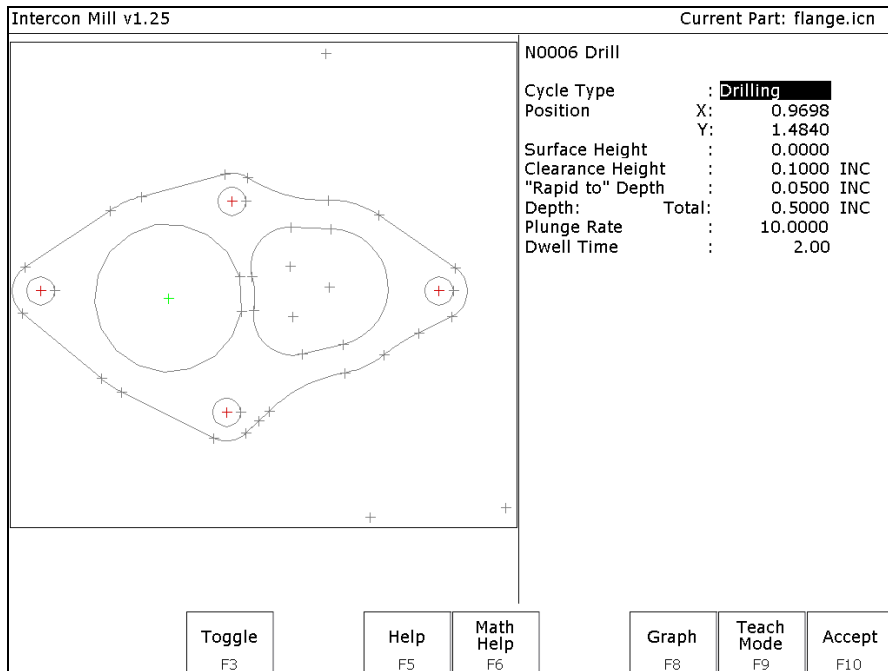

The key **F2 - Single** only appears when a point is highlighted. The keys **F5 - Undo** and **F10 - Done** only appear when one or more points have been selected with **F1 - Window** or **F2 - Single**.

Using a mouse

In addition to the arrow keys, a mouse may be used to position the crosshairs in the DXF selection menus. Simply move the mouse pointer to the desired crosshair location and click the left mouse button. This action will move the crosshairs to the location of the mouse click and highlight the closest object.

Intercon Tutorial #1

This is a step-by-step instructional example of going from blueprint to part with Intercon. The tool path to be created is for the part shown in Figure 1. For instructional purposes, this part will be programmed to cut into stock held in 3 fixtures, 6 inches apart along the X-axis.

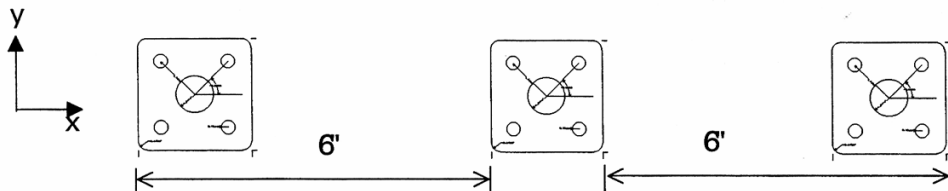
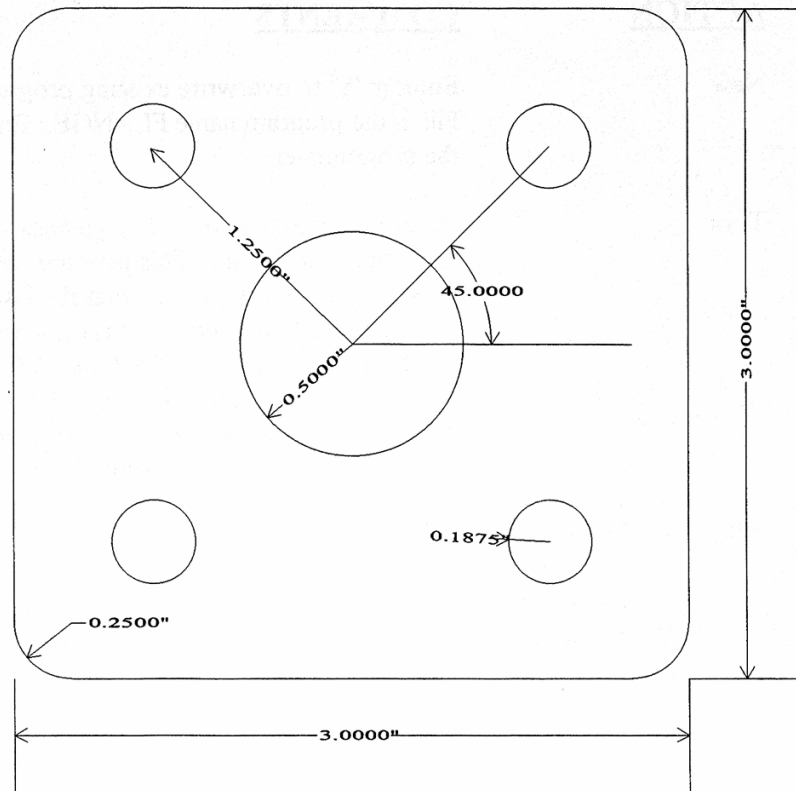

FIG. 1 Blueprint of flange part and the 3 fixtures.

Part Creation

Each feature of the part will become an operation in your program. Before beginning, decide where you want the **X0** and **Y0** reference. For this particular part, the center of the bolt hole pattern was selected. Now start the Intercon program (from the **CNC software main screen**, press **F5 - CAM**). Beginning from the Intercon File Menu (press **F1 - File** if the file menu is not shown) the following series of keystrokes will describe the step-by-step process of designing the part shown in Figure 1.

PRESS

COMMENTS

F1 - New

Fill in the program name *flange*. Enter your name in as the programmer. Enter the description as "Intercon Tutorial #1".

F4 - Tool

Describe the tool below. The position values specify where to do the tool change. This position should be a point outside of the workpiece so that the last tool can be removed from the chuck and the new tool can be inserted. The Yes in the 'Actual Tool Change' field turns off the spindle and coolant upon reaching this spot. Use a 0.3750-inch diameter cutter. The length and diameter are updated based on the offsets. (The longest tool should have a 0.0000 length).

N0020 Tool change

Tool Number	:	1
Description	:	3/8" end mill
Position:	X	: -2.0000
	Y	: -2.0000
Tool H Offset	:	1
Tool Height	:	0.0000
Tool D Offset	:	1
Tool Diameter	:	0.3750
Spindle Speed	:	1000
Spindle Direction	:	CW (M3)
Coolant Type	:	Flood (M8)
Actual Tool Change	:	Yes

F10 - Accept

Keep selected values.

F5 - Cycles

Access the list of available Canned Cycles.

F6 - Circ. Pocket

Start with the 1.0000-inch diameter circular pocket. Enter the following values:

N0030 Circular pocket

Center:	X	:	0.0000	
	Y	:	0.0000	
Surface Height		:	0.0000	
Diameter		:	1.0000	
Cleanout		:	Yes	
Depth:	Total	:	0.5000	INC
Per Pass		:	0.2500	
Plunge Rate		:	2.0000	[M]
Plunge Type		:	Ramped	
Plunge Angle		:	0.00°	
Rough Cuts		:	Conventional	
Stepover		:	0.2250	
Feedrate		:	20.0000	[M]
Finish Pass		:	Climb	
Amount		:	0.0020	
Feedrate		:	10.0000	[M]

F10 - Accept

Keep selected values.

F5 - Cycles

Access the list of available Canned Cycles.

F1 - Drill

Select drilling cycles

F2 - Drill BHC

Select the bolt hole circle type of drilling cycles

N0040 Drill bolt holes

Cycle Type		:	Drilling	
Center:	X	:	0.0000	
	Y	:	0.0000	
Surface Height		:	0.0000	
Clearance Height		:	0.2500	INC
'Rapid To' Depth		:	0.1000	INC
Depth:	Total	:	0.5000	INC
Plunge Rate		:	2.0000	
Dwell Time		:	0.0000	
Number of holes		:	4	
Radius		:	1.2500	
Start angle		:	45.00°	

F8 - Graph

Display a preview of the part up to this point. This preview can be used to detect problems that may occur if the part was cut now.

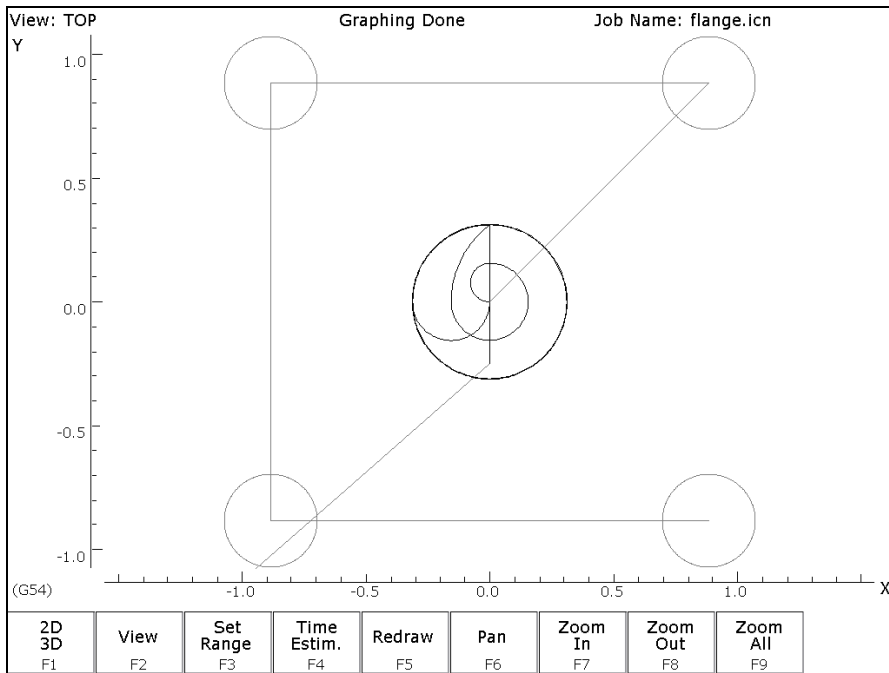

FIG. 2 - Graphics screen showing bolt holes and circular pocket

ESC/CANCEL

Return to the editing screen.

F10 - Accept

Keep selected values.

F5 -Cycles

Access the list of available Canned Cycles.

F7 - Frame

Now add an outside frame to cut the flange out of the material. The flange is 3.0000 inches long by 3.0000 inches wide, and has rounded corners with 0.2500-inch radii.

N0050 Frame mill

Frame	:	Outside Rect	
Center:	X	: 0.0000	
	Y	: 0.0000	
Surface Height	:	0.0000	
Length	X	: 3.0000	INC
Width	Y	: 3.0000	INC
Corner Radius	:	0.2500	
Depth:	Total	: 0.5000	INC
per Pass	:	0.2500	
Plunge Rate	:	2.0000	
Plunge Type	:	Ramped	
Plunge Angle	:	0.00°	
Cut Type	:	Conventional	
Feedrate	:	10.0000	

F8 - Graph

Display a preview of the part up to this point. This preview can be used to detect problems that may occur if the part was cut now.

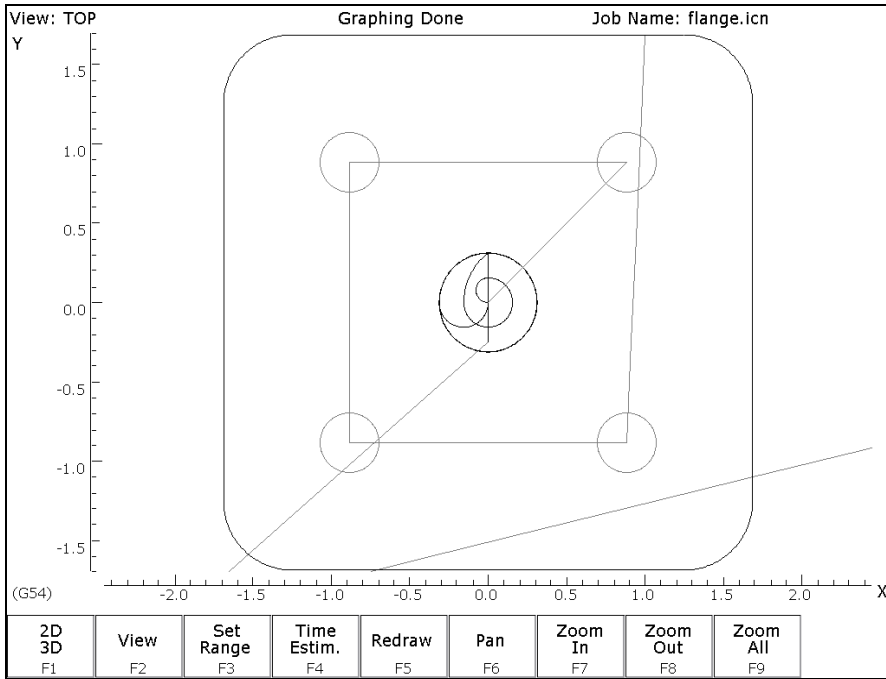

FIG. 3 - Graphics screen showing part with bolt holes and outer frame

ESC/CANCEL

Return to the editing screen.

F10 - Accept

Keep selected values.

F9 - Subpgm

Access the **Insert Subprogram** screen.

F2 - Repeat

We programmed the part to cut one copy only. We now want to repeat the part 2 more times at an incremental distance of 6 inches along the X-axis. The part can now be cut into the stock mounted into the two other fixtures. The part begins with the circular pocket in operation #0003 and ends with the linear mill in operation #0005. Press **F2 - Z Home** to enter “Home” for “Clearance Height”.

N0060 Repeat

Start Block	:	N0003
End Block	:	N0005
Increment	X :	6.0000
	Y :	0.0000
Clearance Height	:	Home
Plunge Rate	:	2.0000
Number of copies	:	2

F8 - Graph

Display a preview of the parts. This preview can be used to detect problems that may occur if the part was cut now.

ESC/CANCEL

Return to Repeat Subprogram.

F10 - Accept

Keep selected values if you wish to cut these two extra parts. If you do not wish to do this, press **ESC/CANCEL**.

ESC/CANCEL

Creation of the part is complete. Intercon programs automatically turn the spindle and coolant off at the end.

F1 - File

Press **F3 - Save** to save the part under its current name. Press **F4 - Save As** to save it under a new name.

F10 - Post

The CNC file needed to run this part on your mill will be generated at this time. The Intercon program displays the operation number of the part it is processing as it works through each operation in memory:

Generating CNC Program
Block 0050

As it processes each operation, it checks for values that, if used, will cause incorrect code to be produced. If such a value is found, a message will appear on the screen alerting you of the problem. For example, a problem with a Frame Mill may produce this message:

Message
Corner radius too small for Cutter...hit a key.

Changes to the part would then be required to allow proper code generation to proceed. If no problems are encountered during code generation, the following message appears:

Message
CNC code generation successful

You are now finished designing your part. In order to run your part, you now need to return to the CNC software.

Program Finished!

Milling the Part

Now that the part has been programmed, it is time to mill it. Take your material and clamp it to the table. Remember that the clamps must be positioned such that they do not interfere with the tool as it cuts. You may choose either to place the clamps around the edges of the material for the entire process and let the part drop through upon completion, or you may wish to pause after milling the circular pockets and place clamps through the holes to prevent the part from moving. The second option decreases the chance of the part being marred because it moved during milling.

Now you need to set your XYZ reference points. Insert your longest tool in the quill and follow the procedure listed below:

PRESS	COMMENTS
JOG KEYS	Jog the table so that your tool rests on the stock at the location that will represent X0 and Y0.
F1 - Setup	Enter the CNC software Setup screen. We are going to establish the part XYZ zero at the current tool location.
F1 - Part	Access the Part Setup options.
F10 - Set	Set your X zero position at current tool location.
F1 - Next Axis	Select the Y-axis next.
F10 - Set	Set your Y zero position at current tool location.
F1 - Next Axis	Select the Z-axis next.
F10 - Set	Set your Z zero position at current tool location.
TOOL CHECK	Moves the quill to the Z home position if the home position has been set. Moves tool to Z+ limit switch and sets home position if not.
ESC/CANCEL	Leave Part Setup screen.
F2 - Tool	Access Tool Library Editor. This is the place where we want to measure the actual heights of our tools (since we could not set the actual values in Intercon).
F1 - Offset Lib.	You need to make sure that the tool diameter and height offset values are the correct ones for the tools you are going to be using. Inspect the values for D001 and H001. D001 should be 0.375, H1 should be 0.0000 (the two inch tool). If either of these values are incorrect, use the arrow keys to select the incorrect values. Enter the new values in their places and press ENTER to accept them.
	<i>NOTE:</i> The tool heights used above are merely example heights. In order to accurately measure the heights of your tools, see the description of measuring tool heights in Chapter 5.
F10 - Save	Keep the updated tool offset library values.

F2 - Tool Lib.

Now you need to make sure that each tool uses the correct diameter and height offset values. Inspect the values for T001. T1 should use H001 and D001. If any of these values are incorrect, use the arrow keys to select the incorrect values. Enter the new values in their places and press **ENTER** to accept them. You may also select spindle and coolant settings for your tools here, or enter a short description of the tool.

F10 - Save

Keep the updated Tool Library values.

ESC/CANCEL

Leave Tool Setup. Return to the CNC software Setup Screen.

ESC/CANCEL

Leave CNC software Setup. Return to the CNC software Main Screen.

CYCLE START

The **CYCLE START** button is located on your jog panel. This key will cause the mill to begin cutting your part

Tutorial Complete!

Intercon Tutorial #2

This demonstration will show you how to create a tool path for a part from a blueprint using the Math Help function of Intercon. The tool path to be created is for the part shown in Figure 1 below.

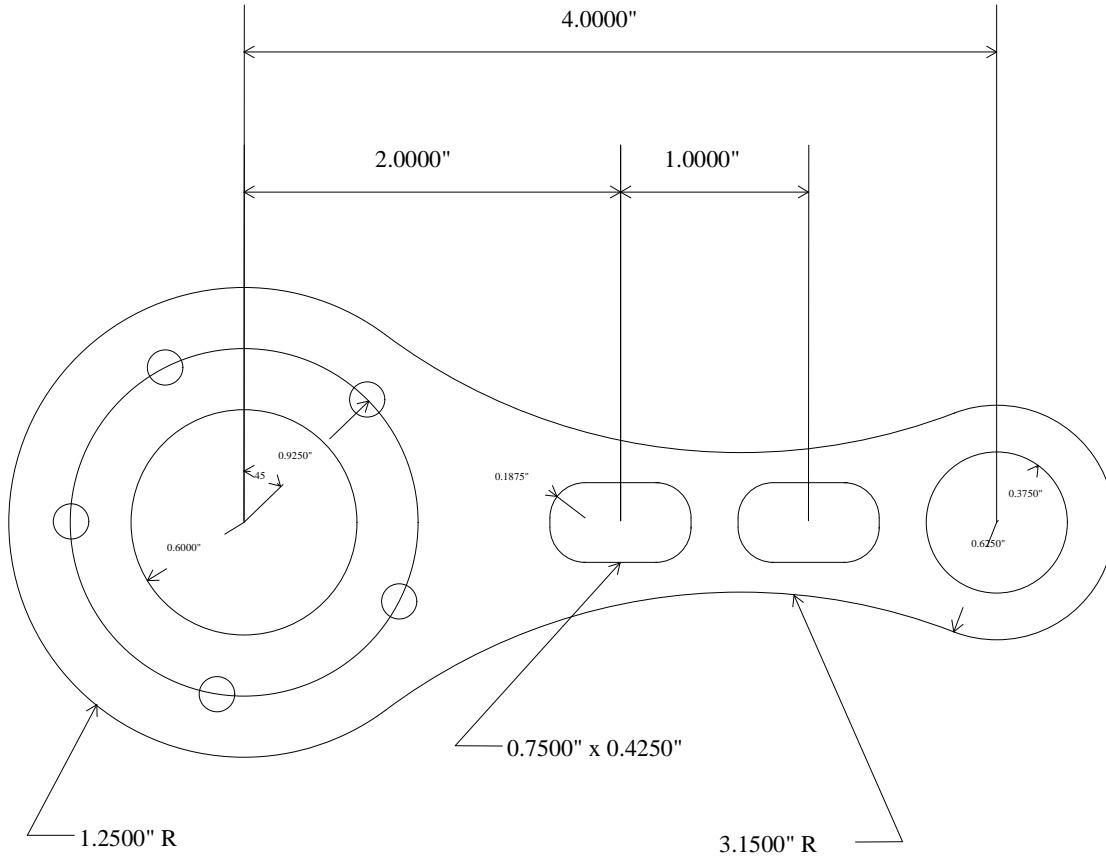

FIG. 1 - Part to be machined.

Part Creation

The process of creating a part is called part programming. Each feature of the part will become an operation in your program. Before beginning, decide where you want the **X0** and **Y0** reference. For this particular demo, the center of the Bolt Hole pattern was selected for convenience). Beginning from the Intercon File Menu (press **F1 - File** if the file menu is not shown) the following series of keystrokes will describe the step-by-step process of designing the part shown in Figure 1.

PRESS

COMMENTS

F1 - New

Create a new program by filling in the appropriate program name (we recommend *c_rod*) and your name. Press **Enter** or **F10 - Accept** to accept the new name. Enter "Intercon Tutorial #2" for the description. Press **F10 - Accept** to accept.

F4 - Tool

Describe the tool below. The position values specify where to do the tool change. The Yes in the 'Actual Tool Change' field turns off the spindle and coolant upon reaching this spot. Use a 0.1875 inch drill. The height and diameter are updated based on the offsets. (The longest tool should have a 0.0000 height offset). If this tool does not have the desired spindle (CW) and coolant (Flood) settings, you should also select these values to match your particular machine setup.

N0002 Tool change

Tool Number	:	1
Description	:	0.187" Drill
Position:	X	: 0.0000
	Y	: 0.0000
Tool H Offset	:	1
(Tool Height	:	0.0000)
Tool D Offset	:	1
Tool Diameter	:	0.1875
Spindle Speed	:	1000
Spindle Direction	:	CW (M3)
Coolant Type	:	Flood (M8)
Actual Tool Change	:	Yes

Notice for this particular screen, the Tool height shows '0.0000', since it has the same tool height as the Reference tool. However, your screen may differ since Intercon cannot change the Reference tool height in the Tool Library. This will change when you run this program. Refer to the Measuring Tool Heights in Chapter 5 for more details.

F10 - Accept

Keep selected values.

F5 - Cycles

Access the list of available Canned Cycles.

F1 - Drill

Select drilling cycles

F2 - Drill BHC

Select a bolt hole circle operation.

The clearance height is the Z height from which the downward rapid traverse begins before each hole. It is also the Z height to which the tool returns upon completion of drilling the hole.

The 'Rapid To' depth is the Z height to which the tool rapid traverses before drilling a hole.

BOLT HOLE CIRCLE

Number of holes: 5

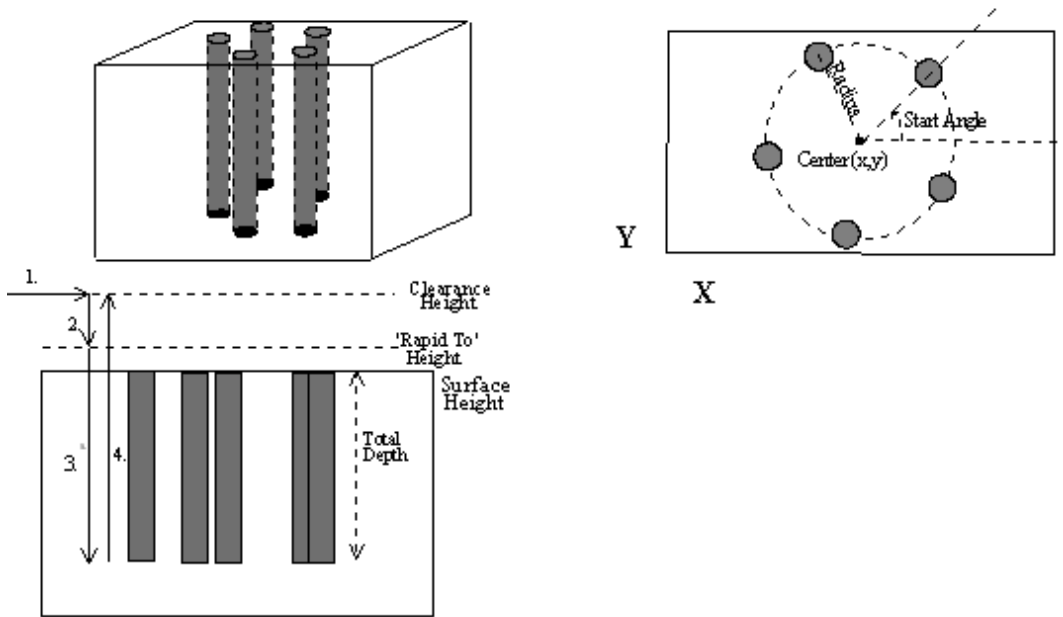

FIG. 2 - Bolt Hole Circle

N0003 Drill bolt holes

Cycle Type	:	Drilling	
Center:	X	: 0.0000	
	Y	: 0.0000	
Surface Height	:	0.0000	
Clearance Height	:	0.5000	INC
'Rapid To' Depth	:	0.1000	INC
Depth:	Total	: 0.5100	INC
Plunge Rate	:	2.0000[M]	
Dwell Time	:	0.0000	
Number of holes	:	5	
Radius	:	0.9250	
Start angle	:	45.00°	

F10 - Accept

Keep selected values.

F4 - Tool

Use a 0.2500 diameter end mill now. Notice that the tool height shown below is a negative value. This value represents the difference in height between this tool and the longest tool being used. The longest tool used (in this case, operation N0020 above) has a height of 0.0000. Again, do not be alarmed if the Tool Height is not -1 for operation N0040. If this tool does not have the desired spindle (CW) and coolant (Flood) settings, you should also enter values specific to your machine setup.

N0004 Tool change

Tool Number	:	2
Description	:	0.250 Dia End Mill
Position:	X	: 0.0000
	Y	: 0.0000
Tool H Offset	:	2
(Tool Height)	:	(Your tool)
Tool D Offset	:	2
Tool Diameter	:	0.2500
Spindle Speed	:	1000
Spindle Direction	:	CW (M3)
Coolant Type	:	Flood (M8)
Actual Tool Change	:	Yes

F10 - Accept

Keep selected values.

F5 - Cycles

Access the list of available canned cycles.

F6 - Circ. Pocket

Start with 1.2000 inch diameter Pocket.

N0005 Circular pocket

Center:	X	:	0.0000
	Y	:	0.0000
Surface Height	:		0.0000
Diameter	:		1.2000
Cleanout	:		Yes
Depth:	Total	:	0.5100 INC
	Per Pass	:	0.2500
	Plunge Rate	:	2.0000 [M]
	Plunge Type	:	Ramped
	Plunge Angle	:	0.00 °
Rough Cuts	:		Conventional
	Stepover	:	0.2000
	Feedrate	:	2.0000 [M]
Finish Pass	:		Climb
	Amount	:	0.1000
	Feedrate	:	2.0000 [M]

F10 - Accept

Keep selected values.

F5 - Cycles

Access the list of available canned cycles.

F6 - Circ. Pocket

Repeat above pocket cycle. The center X value 4.0000 and the diameter is 0.7500 inches.

N0060 Circular pocket

Center:	X	:	4.0000	
	Y	:	0.0000	
Surface Height		:	0.0000	
Diameter		:	0.7500	
Cleanout		:	Yes	
Depth:	Total	:	0.5100	INC
	Per Pass	:	0.2500	
	Plunge Rate	:	2.0000	
	Plunge Type	:	Ramped	
	Plunge Angle	:	0.00	°
Rough Cuts		:	Conventional	
	Stepover	:	0.2000	
	Feedrate	:	2.0000	
Finish Pass		:	Climb	
	Amount	:	0.1000	
	Feedrate	:	2.0000	

F10 - Accept

Keep selected values.

F5 - Cycles

Access the list of available Canned Cycles.

F5 - Rect. Pocket

Cut the first rectangular pocket.

N0070 Rectangular pocket

Center:	X	:	2.0000	
	Y	:	0.0000	
Surface Height		:	0.0000	
Length	(X)	:	0.7500	INC
Width	(Y)	:	0.4250	INC
Corner Radius		:	0.1875	
Depth:	Total	:	0.2500	INC
	Per Pass	:	0.2500	
	Plunge Rate	:	2.0000	
	Plunge Type	:	Ramped	
	Plunge Angle	:	0.00	°
Rough Cuts		:	Conventional	
	Stepover	:	0.1000	
	Feedrate	:	2.0000	
Finish Pass		:	None	
	Amount	:	0.0000	
	Feedrate	:	2.0000	

F10 - Accept

Keep selected values.

F5 - Cycles

Access the list of available Canned Cycles.

F5 - Rect. Pocket

Repeat above Pocket cycle. The center X value lies at 3.0000.

N0080 Rectangular pocket

Center:	X :	3.0000	
	Y :	0.0000	
Surface Height	:	0.0000	
Length	(X) :	0.7500	INC
Width	(Y) :	0.4250	INC
Corner Radius	:	0.1875	
Depth:	Total :	0.2500	INC
	Per Pass :	0.2500	
	Plunge Rate :	2.0000	
	Plunge Type :	Ramped	
	Plunge Angle :	0.00	°
Rough Cuts	:	Conventional	
	Stepover :	0.1000	
	Feedrate :	2.0000	
Finish Pass	:	None	
	Amount :	0.0000	
	Feedrate :	2.0000	

F10 - Accept

Keep selected values.

F1 - Rapid

Move to a location outside the part. The purpose of this move is to prepare to use cutter compensation on the tool.

N0009 Rapid traverse

End:	X :	5.0000
	Y :	0.5000
	Z :	0.1000
Angle	:	14.0365°
Length	:	2.0615

F10 - Accept

Keep selected values.

F2 - Linear

Need to do a zero length move to move the cutter down to z-depth before starting the lead in move to the part. Not including the zero length move to z-depth would confuse cutter comp. and cause the program to do weird things.

N0010 Linear Move

End	X :	5.0000
	Y :	0.5000
	Z :	-0.0500
Angle	:	0.0000
Length	:	0.0000
Connect Radius	:	0.0000
Feedrate	:	10.0000

F10 - Accept

Keep selected values.

F7 - Cutter Comp

Hit **Space** until Left cutter compensation is selected. The tool must move outside of the part outline at a distance at least equal to its radius so the part outline is the correct size.

N00011 Comp left

F10 - Accept

Keep selected values.

F3 - Arc

Mill up to the edge of the part to cut the first arc. This is called a lead-in move. The cutter compensation selected above needs a lead-in move in order to position the cutter before milling the actual part.

N0012 Arc

Arc Type:	:	EP&R
Mid	X :	
	Y :	
	Z :	
End	X :	4.625
	Y :	0.0000
	Z :	-0.0500
Center:	X :	
	Y :	
	Z :	
Angle	:	
Radius	:	.5
Plane	:	XY
Direction	:	CCW
Connect Radius	:	0.0000
Feedrate	:	10.0000
Angle <= 180	:	Yes

You will see that after you enter in these values, the other points and arcs will be entered in automatically.

F10 - Accept

Keep selected values.

F3 - Arc

The first arc to be cut is labeled as ARC 1 in Figure 3 below. The start point, labeled P1, is the end point of the previous move. The end point of the arc will be generated with Math Help. We will be using end point and radius (EP&R) arcs.

FIG 3. - Tangent point and arc reference.

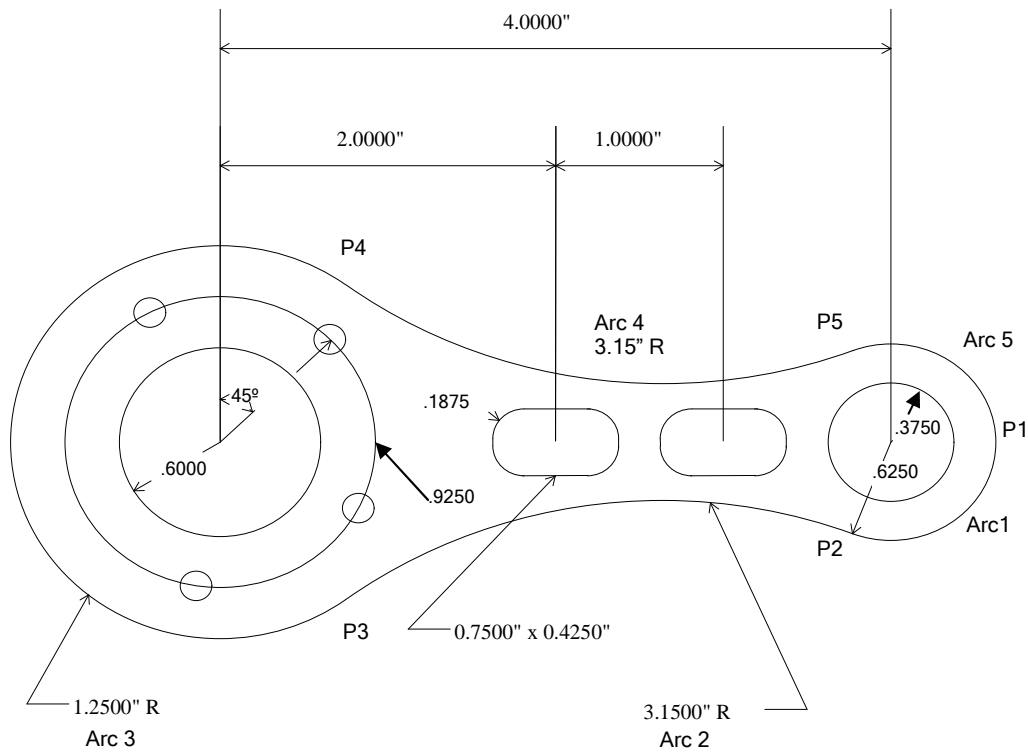

N0013 Arc

Arc type	:	EP&R
Mid	X :	
	Y :	
	Z :	
End:	X :	4.6250
	Y :	0.0000
	Z :	-0.0500
Center:	X :	
	Y :	
	Z :	
Angle	:	
Radius	:	.625
Plane	:	XY
Direction	:	CW
Connect Radius	:	0.0000
Feedrate	:	10.0000
Angle <= 180°	:	Yes

F6 - Math Help

We are trying to find end points for the arcs that make up the outside edge of the part. Note: the main Math Help menu will list all available Math Help solvers.

F6 - Tangent Arc Arc Arc

This scenario will generate tangent points P2 - P5 of Figure 3. Enter the values as shown below:

Arc Tangent Arcs:

Circle 1:	
X :	4.0000
Y :	0.0000
Radius :	0.6250
Circle 2:	
X :	0.0000
Y :	0.0000
Radius :	1.2500
Radius :	3.1500

Intercon will calculate the missing values for this scenario.

F2 - Next Soln

Find scenario that corresponds to the actual arcs being milled. Observe Figure 4. Point T1 is the one needed.

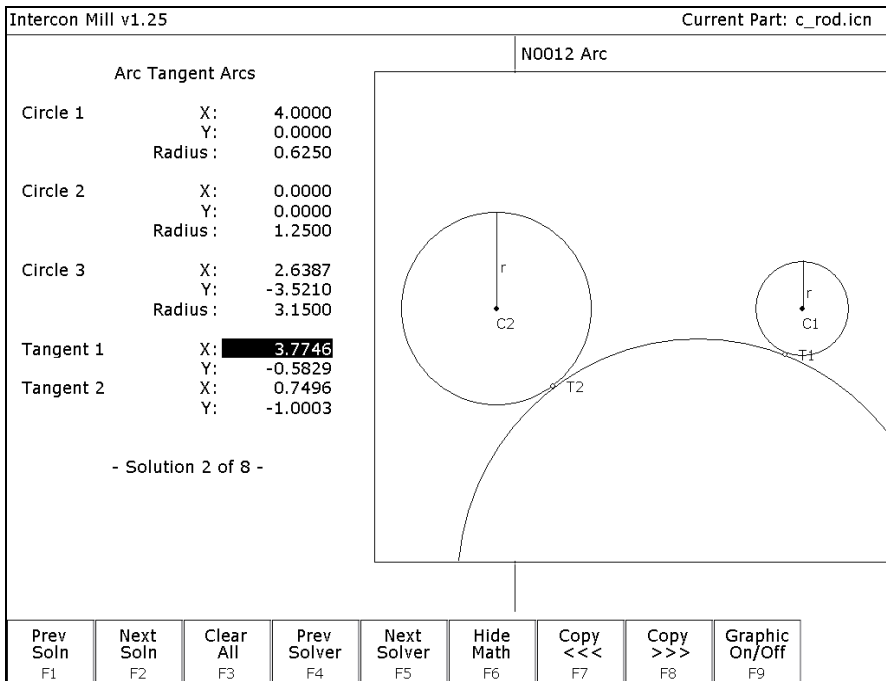

FIG. 4 - Screen showing Math Help Arc Tangent Arc solutions

ARROWS

If necessary, move the block cursor to the Tangent 1 X field as shown above. Note: Use only <↑> and <↓>. If you press the right arrow, press the left arrow to get back to the Math Help fields.

F9 - Graphic on/off

Press to hide the graphical display and reveal the arc operation behind it.

→ (ARROW)

Move the cursor to the arc operation. The solid block cursor on the left side of the screen will be replaced by an outlined

rectangle and the solid block will appear in the arc operation on the right.

ARROWS

Move the block cursor to the End X field of the arc operation. As before, use only <↑> and <↓>.

F8 - Copy >>>

Transfer the tangent point T1 value for X into the end point X coordinate. The active fields on both sides of the screen advance automatically.

F8 - Copy >>>

Transfer the tangent point T1 value for Y into the end point Y coordinate.

ARROWS

Move down to the radius field and enter the radius of the arc labeled as ARC 1 in Figure 3. (This radius is 0.6250 in.).

Arc type	:	EP&R
Mid	X	:
	Y	:
	Z	:
End	X	: 3.7746
	Y	: -0.5829
	Z	: -0.0500
Center:	X	:
	Y	:
	Z	:
Angle	:	:
Radius	:	0.6250
Plane	:	XY
Direction	:	CW
Feedrate	:	10.0000
Angle <= 180°	:	Yes

F6 - Hide Math

Hide Math Help temporarily. (We will return later to pick up the other tangent points.)

F8 - Graph

Observe Figure 5. The graphics show a preview of the part up to this point. This preview can be used to detect problems that may occur if the part was cut now.

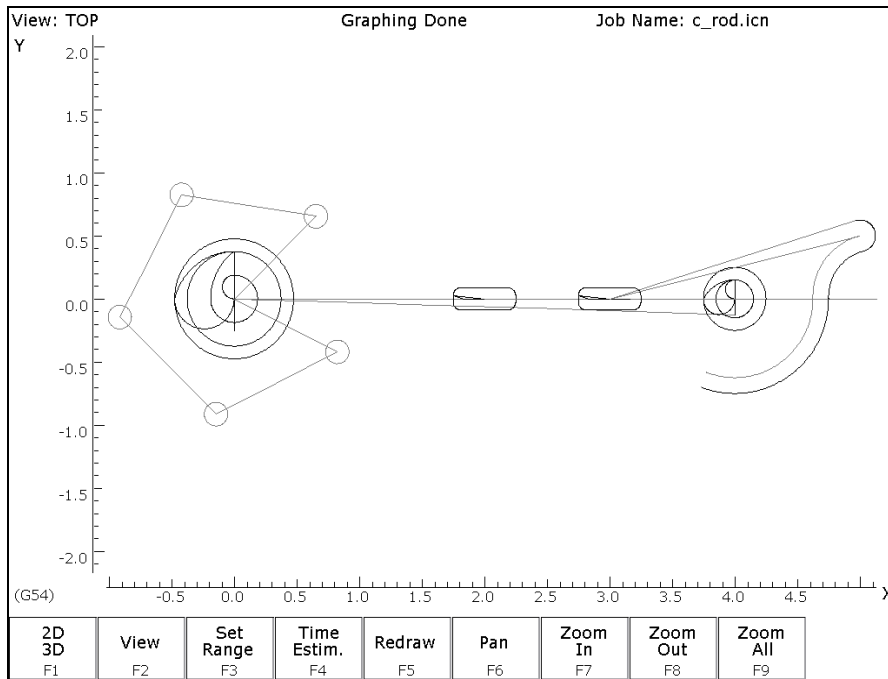

FIG. 5 - Draw screen showing Bolt Holes, Pockets and first arc of part

ESC/CANCEL

Return to the editing screen.

F10 - Accept

Keep selected values. The other arc values were calculated for you.

F3 - Arc

The next arc to be cut is labeled as ARC 2 in Figure 3. The start point is labeled P2, the end point of the last arc.

N0014 Arc

↑↓(UP/DOWN)

Move down to the End X field. This selects End X as the destination of the Math Help solution.

F6 - Math Help

Redisplay the Math Help values calculated for the last arc. The screen will look like figure 6, below.

Intercon Mill v1.25		Current Part: c_rod.icn	
Arc Tangent Arcs		N0013 Arc	
Circle 1	X: 4.0000 Y: 0.0000 Radius: 0.6250	Arc Type	: EP & R
Circle 2	X: 0.0000 Y: 0.0000 Radius: 1.2500	Mid	X: ***** Y: ***** Z: *****
Circle 3	X: 2.6387 Y: -3.5210 Radius: 3.1500	End	X: <input type="text" value="3.7746"/> Y: -0.5829 Z: -0.0500
Tangent 1	X: 3.7746 Y: -0.5829	Center	X: ***** Y: ***** Z: *****
Tangent 2	X: <input type="text" value="0.7496"/> Y: -1.0003	Angle	: ***** °
- Solution 2 of 8 -		Radius	: 0.0000
		Plane	: XY
		Direction	: CW
		Connect Radius	: 0.0000
		Feedrate	: 10.0000
		Angle <= 180	: Yes
Prev Soln F1	Next Soln F2	Clear All F3	Prev Solver F4
Next Solver F5	Hide Math F6	Copy <<< F7	Copy >>> F8
		Graphic On/Off F9	

FIG. 6 – New arc 2 entry screen shown with solution for arcs 1 and 2 of Figure 3.

↑↓(UP/DOWN)

If necessary, move the block cursor to the Tangent 2 X field as shown above. The rectangle at End X shows that it will be the destination of the copy.

F8 - Copy >>>

Transfer the tangent point T2 value for X into the end point X coordinate. The active fields on both sides of the screen advance automatically.

F8 - Copy >>>

Transfer the tangent point T2 value for Y into the end point Y coordinate.

F6 - Hide Math

Hide Math Help temporarily.

↑↓(UP/DOWN)

Move down to the radius field and enter the radius of the arc labeled ARC 2 in Figure 3 (this radius is 3.1500 inches). Set the direction to “CCW”.

Arc type	:	EP&R
Mid	X	:
	Y	:
	Z	:
End:	X	: 0.7496
	Y	: -1.0003
	Z	: -0.0500
Center:	X	:
	Y	:
	Z	:
Angle	:	
Radius	:	3.1500
Plane	:	XY
Direction	:	CCW
Feedrate	:	10.0000
Angle <= 180°	:	Yes

F10 - Accept

Keep selected values.

F3 - Arc

The third arc to be cut is labeled as ARC 3 in Figure 3. The start point is labeled P2, the end point of the previous arc. The end point of the arc will be generated with Math Help.

N0015 Arc

↑↓(UP/DOWN)

Move down to the End X field. This selects End X as the destination of the Math Help solution.

F6 - Math Help

Redisplay the Math Help values calculated for the last arcs.

F9 - Graphic on/off

Redisplays the diagram of the scenario selected to calculate arcs 1 and 2 on Figure 3.

F1 - Prev Soln

Continue pressing F1 until you arrive at the scenario showing arcs 3 and 4 in Figure 3 (in this case, solution #1 is the appropriate one)

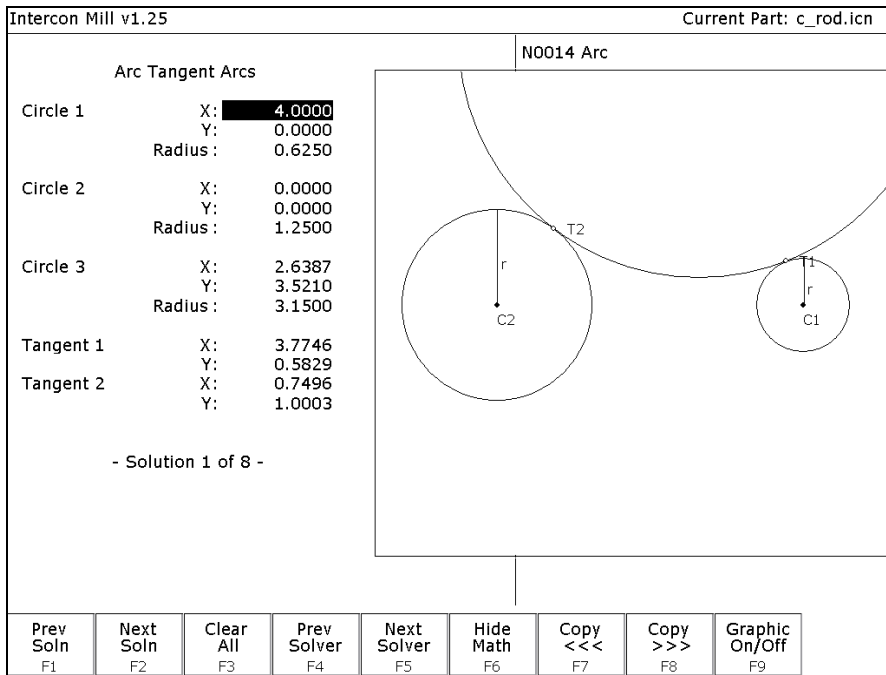

FIG. 7 - Math Help solution for arcs 3 and 4.

↑↓(ARROWS)

Press to highlight the needed tangent point X coordinate in Math Help. Tangent point T2 is the one you want this time.

→(ARROW)

Press to remove the graphic display and move the cursor to the arc operation. (This shortcut saves you from pressing **F9** — **Graphic on/off** to hide the graphics each time.) The solid block cursor on the left side of the screen will be replaced by an outlined rectangle and the solid block will appear in the arc operation on the right.

↑↓(ARROWS)

Move the block cursor to the End X field of the arc operation.

F8 - Copy >>>

Transfer the tangent point T2 value for X into the end point X coordinate. The active fields on both sides of the screen advance automatically.

F8 - Copy >>>

Transfer the tangent point T2 value for Y into the end point Y coordinate.

↑↓(ARROWS)

Move down to the radius field and enter the radius of the arc labeled ARC 3 in Figure 3. (This radius is 1.2500 inches). Also, enter in No for the angle of this arc, since it is greater than 180°.

```

Arc type      : EP&R
Mid:         X :
            Y :
            Z :
End:         X : 0.7496
            Y : 1.0003
            Z : -0.0500
Center:      X :
            Y :
            Z :
Angle        :
Radius       : 1.2500
Plane        : XY
Direction    : CW
Feedrate     : 10.0000
Angle <= 180° : No

```

F10 - Accept

Keep selected values.

F3 - Arc

The fourth arc to be cut is labeled as ARC 4 in Figure 3. The start point, labeled P3, is the end point of the previous arc. The end point of the arc will be generated with Math Help.

N0016 Arc mill

↑↓(ARROWS)

Move down to the End X field. This selects End X as the destination of the Math Help solution.

F6 - Math Help

Re-display the Math Help values calculated for the last arc.

Intercon Mill v1.25		Current Part: c_rod.icn	
Arc Tangent Arcs		N0015 Arc	
Circle 1	X: 4.0000 Y: 0.0000 Radius: 0.6250	Arc Type	: EP & R
Circle 2	X: 0.0000 Y: 0.0000 Radius: 1.2500	Mid	X: ***** Y: ***** Z: *****
Circle 3	X: 2.6387 Y: -3.5210 Radius: 3.1500	End	X: 0.7496 Y: 1.0003 Z: -0.0500
Tangent 1	X: 3.7746 Y: -0.5829	Center	X: ***** Y: ***** Z: *****
Tangent 2	X: 0.7496 Y: -1.0003	Angle	: ***** °
- Solution 2 of 8 -		Radius	: 0.0000
		Plane	: XY
		Direction	: CW
		Connect Radius	: 0.0000
		Feedrate	: 10.0000
		Angle <= 180	: Yes
Prev Soln F1	Next Soln F2	Clear All F3	Prev Solver F4
			Next Solver F5
			Hide Math F6
			Copy <<< F7
			Copy >>> F8
			Graphic On/Off F9

FIG. 8 - New arc 4 entry screen shown with solution for arcs 3 and 4 of Figure 3.

↑↓(UP/DOWN)

Highlight the needed tangent point X. Tangent point T1 is the one you want this time.

ARROWS

If necessary, move the cursor to the arc operation and select the End X field.

F8 - Copy >>>

Transfer the tangent point T1 value for X into the end point X coordinate. The active fields on both sides of the screen advance automatically.

F8 - Copy >>>

Transfer the tangent point T1 value for Y into the end point Y coordinate.

F6 - Hide Math

Hide Math Help.

ARROWS

Move down to the radius field and enter the radius of the arc labeled ARC 4 in Figure 3. (This radius is 3.1500 inches). Be sure to set the direction to CCW.

Arc type	:	EP&R
Mid:	X :	
	Y :	
	Z :	
End:	X :	3.7746
	Y :	0.5829
	Z :	-0.0500
Center:	X :	
	Y :	
	Z :	
Angle	:	
Radius	:	3.1500
Plane	:	XY
Direction	:	CCW
Feedrate	:	10.0000
Angle <= 180°	:	Yes

F10 - Accept

Keep selected values.

F3 - Arc

Mill the arc labeled as ARC 5 in Figure 3 back to point P1.

N0017 Arc mill

Operation type	:	EP&R
Mid:	X :	
	Y :	
	Z :	
End:	X :	4.6250
	Y :	0.0000
	Z :	-0.0500
Center:	X :	
	Y :	
	Z :	
Angle	:	
Radius	:	0.6250
Plane	:	XY
Direction	:	CW
Feedrate	:	10.0000
Angle <= 180°	:	Yes

F10 - Accept

Keep selected values.

F3 - Arc

Move tool away from the edge of the part after the last arc.

N0018 Arc mill

Arc type	:	EP&R
Mid:	X :	
	Y :	
	Z :	
End:	X :	5.0000
	Y :	-0.5000
	Z :	-0.0500
Center:	X :	
	Y :	
	Z :	
Angle	:	
Radius	:	0.5000
Plane	:	XY
Direction	:	CCW
Feedrate	:	10.0000
Angle <=180°	:	Yes

F10 - Accept

Keep selected values.

F7 - Cutter Comp

Hit the space bar until cutter compensation is turned '**Off**'. It is no longer needed.

N0019 Comp off

F10 - Accept

Keep selected values.

F1 - Rapid

Move the tool away from the part. This is called a lead-out move. When cutter compensation is turned off, the compensation is removed during the next move. This must be done to allow the CNC software to correct its position.

N0020 Rapid traverse

End:	X :	5.0000
	Y :	-0.5000
	Z :	0.1000
Angle	:	0.0000°
Length	:	0.0000

F10 - Accept

Keep selected values.

F9 - Subpgm

Access the **Subprogram** screen.

F1 - Depth Repeat

We programmed the outer contour of the part so that our tool would only penetrate a small portion of the material per pass. We now want to repeat the outer contour operations until the tool has cut the entire way through the material (the assumed material thickness is 0.5 inches). The outer contour begins with the Plunge in operation N0011 and ends with the Linear Mill in operation N0017.

N0021 Repeat to Depth

Start Block	:	0011
End Block	:	0020
Total Depth	:	0.5100 INC
Depth Increment	:	0.0500 INC
Clearance Height	:	0.2500
Plunge Rate	:	5.0000

F10 - Accept

Keep selected values.

F1 - Rapid

Move the tool away from the part. This is called a lead-out move. When cutter compensation is turned off, the compensation is removed during the next move. This must be done to allow the CNC software to correct its position.

N0022 Rapid traverse

End:	X :	0.0000
	Y :	0.0000
	Z :	3.0000
Angle	:	174.2894°
Length	:	5.0249

F10 - Accept

Keep selected values.

ESC/CANCEL

Creation of the part is complete. Intercon programs automatically turn the spindle and coolant off at the end.

F8 - Graph

Display a preview of the finished part. Just make sure that the finished part is going to look the way you want it to. The display shown in Figure 7 has rulers placed around the various view windows that are scaled to the same size as the part displayed to allow visual inspection of the part. Remember, this preview shows where the center of the current tool will move (cutter compensation is not represented except in pocket and frame displays).

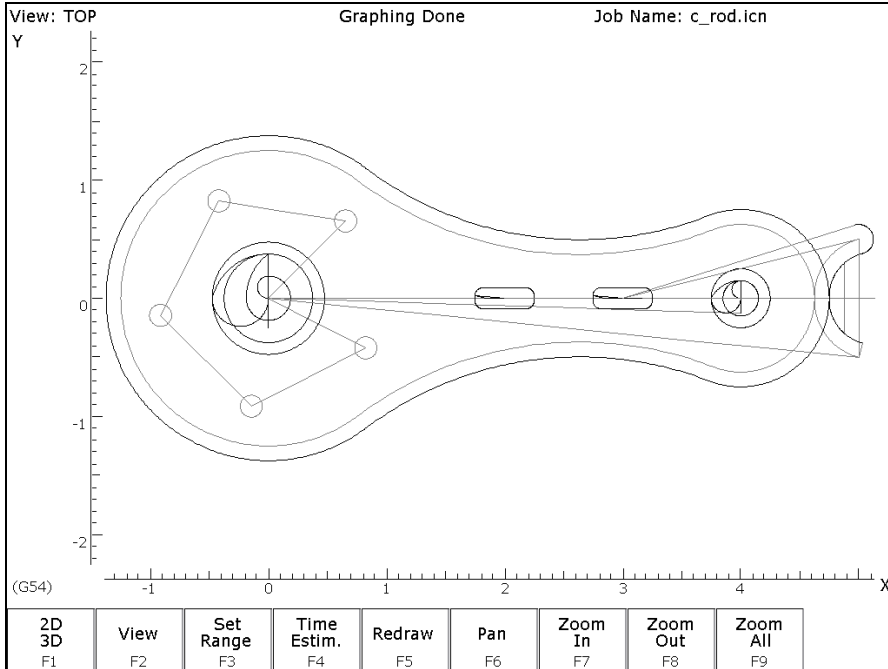

FIG. 9 - Draw screen showing complete part

ESC/CANCEL

Return to Main screen.

F1 - File

Go to the File Menu. Press **F3 - Save** to save under the current file name or press **F4 - Save As** to save the program under a different name.

F10 - Post

The CNC file needed to run this part on your mill will be generated at this time. The Intercon program displays the operation number of the part it is processing as it works through each operation in memory:

Generating CNC Program

Block 0050

As it processes each operation, it checks for values that, if used, will cause incorrect code to be produced. If such a value is found, a message will appear on the screen alerting you of the problem. For example, a problem with a rectangular pocket may produce this message:

Message

Corner radius too small for Cutter...hit a key.

Changes to the part would then be required to allow proper code generation to proceed. If no problems are encountered during code generation, the following message appears:

Message

CNC code generation successful

You are now at the main menu again.

You are now finished designing your part. In order to run your part, you now need to return to the CNC software.

Program Finished!

Milling the Part

Now that the part has been programmed, it is time to mill it. Take your material and clamp it to the table. Remember that the clamps must be positioned such that they do not interfere with the tool as it cuts. You may choose to place the clamps around the edges of the material for the entire process and let the part drop through upon completion, or you may wish to pause after milling the circular pockets and place clamps through the holes to prevent the part from moving. The second option decreases the chance of the part being marred because it moved during milling.

Now you need to set your **XYZ** reference points. Insert your longest tool in the quill and follow the procedure listed below:

PRESS	COMMENTS
JOG KEYS	Jog the table so that your tool rests on the stock at the location that will represent X0 and Y0.
F1 - Setup	Enter the CNC software Setup screen. We are going to establish the part XYZ zero at the current tool location.
F1 - Part	Access the Part Setup options.
F10 - Set	Set your X zero position at current tool location.
F1 - Next Axis	Select the Y-axis next.
F10 - Set	Set your Y zero position at current tool location.
F1 - Next Axis	Select the Z-axis next.
F10 - Set	Set your Z zero position at current tool location.
TOOL CHECK	Moves the quill to the Z home position if the home position has been set. Moves tool to Z+ limit switch and sets home position if not.
ESC/CANCEL	Leave Part Setup screen.
F2 -Tool	Access Tool Library Editor. This is the place where we want to measure the actual heights of our tools (since we could not set the actual values in Intercon).
F1 - Offset Lib.	You need to make sure that the tool diameter and height offset values are the correct ones for the tools you are going to be using. Inspect the values for D001, H001, D002 and H002. D001 should be 0.1875, H1 should be 0.0000 (the two inch tool), D002 should be 0.2500 and H002 should be -1.0000 (the one inch tool). If any of these values are incorrect, use the arrow keys to select the incorrect values. Enter the new values in their places and press ENTER to accept them.

NOTE: The tool heights used above are merely example heights. In order to accurately measure the heights of your tools, see the description of measuring tool heights in Chapter 5.

F10 - Save

Keep the updated tool offset library values.

F2 - Tools

Now you need to make sure that each tool uses the correct diameter and height offset values. Inspect the values for T001 and T002. T1 should use H001 and D001, while T002 should use H002 and D002. If any of these values are incorrect, use the arrow keys to select the incorrect values. Enter the new values in their places and press **ENTER** to accept them. You may also select spindle and coolant settings for your tools here, or enter a short description of the tool.

F10 - Save

Keep the updated Tool Library values.

ESC/CANCEL

Leave **Tool Setup**. Return to the **CNC software Setup** Screen.

ESC/CANCEL

Leave **CNC software Setup**. Return to the **CNC software Main** Screen.

CYCLE START

The **CYCLE START/START** button is located on your jog panel. This key will cause the mill to begin cutting your part.

Tutorial Complete!

Measuring Tool Heights

The following is a brief description of the method used to measure tool height values (offsets). You will need to insert a reference tool into the quill before beginning. For more information also see chapter 5.

PRESS	ACTION	COMMENTS
F1 - Setup		From the main screen enter the Setup.
F2 - Tool		Enter tool screen.
F1 - Offset Lib.		Enter the tool offsets screen.
JOG ARROWS		You need to jog your reference tool down so it touches the top of some surface.
F1 - Z Ref		Set your Z reference position. This is the value that appears on the DRO when the reference tool touches the top of the surface.
TOOL CHECK		Move the quill up to the Z home position. Insert the first tool to measure.
ARROWS		Select height offset which holds the height of the first tool.
JOG ARROWS		Jog the tool down until it touches the same surface as did the reference tool.
F2 - Manual		Record the height of the first tool.
		Now repeat the last four steps above (from TOOL CHECK to F2 - Manual) for each additional tool to measure.
F10 - Save		Store modifications to offset library of your tools.

Chapter 11

CNC Program Codes

General

The next three chapters contain a description of the CNC program codes and parameters supported by the M-Series Control. The M-Series Control has some G codes and parameters that are modal, and some that are "one shots." The G codes and parameters that are modal will stay in effect until a new G code or parameter is issued. One shots are effective for the current line only. For example, a movement command of G1, which is modal, will remain in effect until a different movement command is issued, such as G0, G2, G3, etc.

Miscellaneous CNC Program Symbols

D - Tool Diameter Offset Number

D is used to select the Tool Diameter Offset from the offset library. The D code values are stored in the Offset Library. Tool Diameter Offsets can be specified anytime before Cutter Comp is turned on (G41 or G42). Once specified, the offset amount is stored and will only be changed when another D code is entered therefore, D is modal. The Tool Diameter Offset (D) can be placed on a line by itself or on a line with other G-codes.

Example:

```
X0Y0F10      ;  
G41 D2       ; Enables cutter comp left with diameter D2.  
G1X0Y0      ;  
X1Y1.25     ; Cutter compensated moves  
X2Y1.4      ;  
G40         ; Cutter compensation off  
G42         ; Enables cutter comp. right (still using D2)
```

E - Select Work Coordinate System

E1 through E18 select among the 18 work coordinate systems. For more information on work coordinate systems see chapter 4.

F - Feedrate

The F command is used to set the cutting feedrate. The feedrate is expressed in units/minute. The programmed feedrate may be modified by the feedrate override knob (2 - 200% for DC systems and 2 – 100% for AC systems). The default feedrate is 3.0 units/minute. Units may be inches or millimeters.

Example:

```
G90 G1 X1.0 F50 ; linear mill to X1 at 50 units/minute
```

H - Tool Length Offset Number

H is used to select the Tool Length Offset Number. The H code offset amounts are stored in the file Offset Library. Tool Length Offsets can be specified anytime before a G43 or G44 is issued. Once specified the offset amount is stored and will only be changed when another H code is entered therefore, H is modal. The Tool Length Offset (H) can be placed on a line by itself or on a line with other G-codes. H00 is always a 0.0 length offset.

Example:

```
H1           ; Selects offset corresponding to H1.
G43 Z3       ; Moves to Z3 using H1 offset.
G1X0Y1       ;
H3           ; Selects offset corresponding to H3.
X1Y1.25      ;
G0H5         ; Selects offset corresponding to H5.
```

* NOTE: For editing instruction for the offset library see chapter 5. For information on length compensation functions see G43 and G44 in Chapter 12.

N - Block Number

Block numbers are used to identify CNC program lines. Block numbers are optional, but can be used as the destinations of GOTO statements (see Advanced Macros in this chapter) and targets of the Search Function (See Main Screen Search option in Chapter 3). Block numbers also can make reading the NC files easier.

Example:

```
N1 G90 G17 M25
N2 G0 X0 Y0 Z0
```

O - Program Number

The O program number allows you to identify your program with a certain number. However, if the specified program number is 9100-9999, the G codes from the O number through the next M99 will be extracted (but not executed) and placed in a separate subprogram/macro file named Oxxx.cnc, where xxx is the specified program number. This separate file can later be called with M98 or G65.

Example:

```
O1521
N1 G90 G17 M25
N2 G0 X0 Y0 Z0
```

P - Parameter

P can correspond to Dwell Time, subprogram number, or a general parameter in canned cycles. This is used as a variable for any of those values in the NC file.

Examples:

```
G4 P1.32      ; Pause execution for 1.32 seconds
G10 P73 R.1   ; Set parameter #73 (G73 retract) to .1 inches
```

Q - Parameter

Q is used as a depth parameter in canned drilling cycles.

Example:

```
G73 X1.5 Y2.0 Z-.75 R.25 Q.25 F5 ; Q Sets the depth cut at .25
```

R - Radius, Return Point, Parameter

R can represent the radius, a return point, or a general parameter. This is used as a variable for any of those values in the NC file. R is similar to the P parameter.

Examples:

```
G10 D5 R.5 ; sets tool diameter #5 to 0.5" in the offset library  
G81 X0 Y0 Z-.5 R.1 F15 ; drill to Z-.5 with return height of .1
```

S - Spindle Speed Setting

Specifying a spindle speed causes the automatic spindle speed setting to be immediately updated. Setting the spindle speed does not cause the spindle to start. The maximum spindle speed is used to compute the output value to the spindle speed control circuit.

Example:

```
S1400 M3 ; Starts the spindle CW at 1400 RPM
```

* NOTE: The Spindle Speed is used in conjunction with the maximum spindle speed to determine the actual spindle speed output to the PLC. Also, this only works when a VFD (Variable Frequency Drive) spindle drive is connected.

T - Select Tool

Prompts the operator to insert the proper tool or change tools, when M6 is encountered.

Example:

```
T1 M6 ; Prompt operator to load tool number 1  
T2 ; no action  
G0X0Y0 ; move to X0 Y0  
M6 ; prompt operator to load tool number 2
```

: - Visible Comment Identifier

The colon (:) is used to indicate the start of a comment line within a CNC program. The colon must be the first character on the line.

Example:

```
: select absolute positioning  
G90  
: XY plane  
G17
```

:Visible comments will be displayed on screen with the G-codes.

; - Internal Comment Identifier

The semicolon (;) is used to indicate the start of an internal comment within a CNC program line. All characters after the semicolon are ignored when the program is run. Internal comments are used to document NC programs or temporarily omit the remainder of a line.

Example:

```
G90 ; select absolute positioning
G17 ; XY plane
G1 X1 Y1 F10
G0 ; X0 Y0 ; G0 selected with no movement
```

[] – Numerical Expression

The left bracket '[' and right bracket ']' are used to delimit a numerical expression. Numerical expressions can contain floating-point numbers or user and system variables in combination with mathematical operators and functions. The left parenthesis '(' or bracket '[' and right parenthesis ')' or bracket ']' can be used between the first left bracket and last right bracket to force operator precedence or associatively. A bracketed numerical expression can be used anywhere a number would be used. Comparison operators ('eq', 'ne', etc.) have built in rounding specified by parameter 144. Without this rounding, 'eq' would usually return "false" when comparing two numbers calculated in different ways. Comparison operators and logical operators ('!', '&&', '||') return 1.0 for "true" and 0.0 for "false".

The mathematical operators and functions are:

+	Addition (or unary positive)	#	Variable access
-	Subtraction (or unary negative)	eq or ==	Equals
*	Multiplication	ne or !=	Not equals
/	Division	ge or >=	Greater than or equals
^	Exponentiation	gt or >	Greater than
Mod or %	Modulo (remainder of a division)	le or <=	Less than or equals
abs	Absolute value	lt or <	Less than
sin	Sine (degrees)	not or !	Logical NOT
cos	Cosine (degrees)	&&	Logical AND
tan	Tangent (degrees)		Logical OR
sqrt	Square root	and	Bit-wise AND
asin	Arc Sine (degrees)	xor	Bit-wise exclusive OR
acos	Arc Cosine (degrees)	or	Bit-wise OR
atan	Arc Tangent (degrees)	~	Bit-wise complement

Examples:

```
G91 X[13/64] Z[1+3/8] ; move the X axis 13/64 (0.2031) units
                        ; and the Z axis 1 3/8 (1.375) units incrementally
X[SQRT[ABS[SIN[#101]-COS[#102]]]] ; Move X as a function of #101 and #102
```

\$ - ASCII Code Substitution

The '\$' symbol followed by an ASCII code is an alternate way of specifying a letter. Only ASCII codes 65 – 90 ('A' – 'Z') are valid. This substitution can be used where a letter command or axis label is normally specified.

Examples:

```
G0 $88 2.0 ; Rapid move X to 2.0 ( Equivalent to G0 X2.0 )
$71 0 $[88+2] 3.0 ; Rapid move Z to 3.0 ( Equivalent to G0 Z3.0 )
M26 /$90 ; Set Z home ( Equivalent to M26 /Z )
```

#, = - User or System Variable reference

The '#' character is used to reference a macro or a user or system variable. For variables that can be written, the '=' is used to assign to them. General purpose user variables are #100 to #149 and #29000 to #31999.

Index	Description	Returns	R/W
1-3	Macro arguments A-C	The floating point value if defined by a G65 call, 0.0 otherwise. These can be used as private, local variables in any program or subprogram except in custom macro M functions. In custom macro M functions, the macro arguments are passed in by reference.	R/W
4-6	Macro arguments I-K (1st set)		R/W
7-9	Macro arguments D-F or 2nd set of I-K		R/W
10	3rd I (G is invalid)		R/W
11	Macro argument H or 3rd J		R/W
12	3rd K (L is invalid)		R/W
13	Macro argument M or 4th I		R/W
14	4th J (N is invalid)		R/W
15	4th K (O is invalid)		R/W
16	5th I (P is invalid)		R/W
17-18	Macro argument Q-R or 5th J-K		R/W
19-21	Macro arguments S,T,U or 6th set of I-K		R/W
22-24	Macro arguments V,W,X or 7th set of I-K		R/W
25-27	Macro arguments Y,Z or 8th set of I-K		R/W
28-30	9th set of I-K		R/W
31-33	10th set of I-K		R/W
100 - 149	User variables	Floating-point value. Initialized to 0.0 at start of job processing	R/W
150 – 159	Nonvolatile user variables	Floating-point value saved in CNCm.JOB file.	R/W
300-399	User string variables. These variables retain their values until the CNC software is exited	String Literal	R/W
2400, 2401-2418	Active WCS, WCS #1-18 CSR angles	Floating point value	R/W
2500, 2501-2518	Active WCS, WCS #1-18 Axis 1 values		R/W
2600, 2601-2618	Active WCS, WCS #1-18 Axis 2 values		R/W
2700, 2701-2718	Active WCS, WCS #1-18 Axis 3 values		R/W
2800, 2801-2818	Active WCS, WCS #1-18 Axis 4 values		R/W
2900, 2901-2918	Active WCS, WCS #1-18 Axis 5 values		R/W
3000, 3001-3018	Active WCS, WCS #1-18 Axis 6 values		R/W
3100, 3101-3118	Active WCS, WCS #1-18 Axis 7 values		R/W
3200, 3201-3218	Active WCS, WCS #1-18 Axis 8 values		R/W
3901	Parts Cut (Part #)		
3902	Parts Required (Part Cnt)		R/W
4001	Move mode	0.0 (rapid) or 1.0 (feed)	R
4003	Positioning mode	90.0 (abs) or 91.0 (inc)	R
4006	Units of measure	20.0 (inches) or 21.0 (metric)	R
4014	WCS	54.0-71.0 (WCS#1-18)	R
4109	Feedrate (F)	Floating point value	R
4119	Spindle Speed (S)		R
4120	Tool Number (T)		R
4121	Current height offset number (H)		R
4122	Current diameter offset number (D, mill only)		R
4201	Job processing state	0 = normal, 1 = graph	R
4202	Job Search mode	0 = search mode off 1 = searching for line number 2 = searching for block number N__ 3 = searching for Tool number 4 = resuming job	R
5021-5028	Machine Position (X=5021, Y=5022, etc.)	Floating point value	R
5041-5048	Current Position (X=5041, Y=5042, etc.)		R
9000-9399	Parameter values 0 – 399	See Chapter 14	R
9900-9999	Parameter values 900 – 999	See Chapter 14	R
10000	Mill: Height offset amount, active H	Floating point value	R/W

Index	Description	Returns	R/W
10001-10200	Mill: Height offset amount, H001 – H200	Floating point value	R/W
11000	Mill: Diameter offset amount, active D	Floating point value	R/W
11001-11200	Mill: Diameter offset amount, D001 – D200	Floating point value	R/W
12000	Mill: Tool H number, active tool (T)	0 - 200	R/W
12001-12200	Mill: Tool H number, tools 1 - 200	0 - 200	R/W
13000	Mill: Tool D number, active tool (T)	0 - 200	R/W
13001-13200	Mill: Tool D number, tools 1 - 200	0 - 200	R/W
14000	Mill: Tool coolant, active tool (T)	7, 8, 9	R/W
14001-14200	Mill: Tool coolant, tools 1 – 200	7, 8, 9	R/W
15000	Mill: Tool spindle direction, active tool (T)	3, 4, 5	R/W
15001-15200	Mill: Tool spindle direction, tools 1 - 200	3, 4, 5	R/W
16000	Mill: Tool spindle speed, active tool (T)	Floating point value	R/W
16001-16200	Mill: Tool spindle speed, tools 1 - 200	Floating point value	R/W
17000	Mill: Tool bin number, active tool (T)	Floating point value	R/W
17001-17200	Mill: Tool bin number, tools 1 - 200	Floating point value	R/W
18000	Mill: Tool putback, active tool (T)	Floating point value	R/W
18001-18200	Mill: Tool putback, tools 1 – 200	Floating point value	R/W
19000	Tool Life Data: Tool T1 Tool Type	0 = Drill, 1 = End Mill	R/W
19001	Tool Life Data: Tool T1 Total Life	Floating point value	R/W
19002	Tool Life Data: Tool T1 Used Life	Floating point value	R/W
19003	Tool Life Data: Tool T1 Units	0 = Cycles, 1 = Inch/mm distance	R/W
19004	Tool Life Data: Tool T1 Update Mode	0 = Manual, 1 = Auto	R/W
19005-19009	Tool Life Data for Tool T2	see 19000-19004 above	R/W
19010-19014	Tool Life Data for Tool T3	see above	R/W
19015-19999	Tool Life Data for Tools T4 through T200	see above	R/W
20001-20008	max_rate for axes 1-8		R
20101-20108	label for axes 1-8		R
20201-20208	slow_jog for axes 1-8		R
20301-20308	fast_jog for axes 1-8		R
20401-20408	screw_pitch for axes 1-8		R/W
20501-20508	lash_comp for axes 1-8		R
20601-20608	counts_per_unit for axes 1-8		R
20701-20708	accel_time for axes 1-8		R
20801-20808	deadstart_velocity for axes 1-8		R
20901-20908	delta_vmax for axes 1-8		R
21001-21008	counts_per_turn for axes 1-8		R
21101-21108	minus_limit for axes 1-8		R
21201-21208	plus_limit for axes 1-8		R
21301-21308	minus_home for axes 1-8		R
21401-21408	plus_home for axes 1-8		R
21501-21508	reversed for axes 1-8		R
21601-21608	laser_comp for axes 1-8		R
21701-21708	proportional for axes 1-8		R
21801-21808	integration_limit for axes 1-8		R
21901-21908	kg for axes 1-8		R
22001-22008	integral for axes 1-8		R
22101-22108	kv1 for axes 1-8		R
22201-22208	derivative for axes 1-8		R
22301-22308	ka for axes 1-8		R
22401-22408	num_motor_poles for axes 1-8		R
22501-22508	drive_current for axes 1-8		R
22601-22608	drive_offset_angle for axes 1-8		R
22701-22708	pwm_kp for axes 1-8		R
22801-22808	pwm_ki for axes 1-8		R
22901-22908	pwm_kd for axes 1-8		R
23001-23008	abrupt_kp for axes 1-8		R
23101-23108	feed_forward_kp for axes 1-8		R
23201-23208	max_error (PID) for axes 1-8		R

Index	Description	Returns	R/W
23301-23308	min_error (PID) for axes 1-8		R
23401-23408	at_index_pulse for axes 1-8		R
23501-23508	travel_minus for axes 1-8		R/W
23601-23608	travel_plus for axes 1-8		R/W
23701-23708	axis_home_set for axes 1-8		R
23801-23808	abs_position (in encoder counts) for axes 1-8		R
23901-23908	PID_out for axes 1-8		R
24001-24008	reference set for axes 1-8		R
24101-24108	Axis reference value for axes 1-8		R
24201-24208	tilt table level offsets for axes 1-8		R
24301-24308	dsp positions for axes 1-8		R
24401-24408	abs_position (in encoder counts) for axes 1-8		R
24501-24508	dsp positon in local coordinatnes for axes 1-8		R
24601-24608	local probing +limit position for axes 1-8		R
24701-24708	local probing -limit position for axes 1-8		R
24801-24808	probe stylus compensation amount for axes 1-8		R
24901-24908	servo controlled axis indicator for axes 1-8	0 = no, 1 = yes	R
25000	DRO_display_units		R
25001	default_units_of_measure		R
25002	PLC_type		R
25003	console_type		R
25004	jog_panel_optional		R
25005	min_spin_high		R
25006	max_spin_high		R
25007	home_at_powerup		R
25008	screen_blank_time		R
25009	Displayed / Calculated spindle speed. If parameter 178 =1 and spindle encoder is mounted.		R
25010	current spindle position (in counts)		R
25011	dsp_time (in seconds)		R
25012	time (in seconds)		R
25013	clear max/min PID errors		R
25014	software type (Mill/Lathe)		R
25015	feedrate override		R
25016	spindle override		R
25017	OS	Windows/LINUX = 2; other OS = 1.0	R
25018	CNC series number (11 for CNC11)		R
25019	Software version number		R
25020	Software Beta revision number		R
25021	Digitizing boundary hit	hit = 1, not hit = 0	R
25022	last M115/116/125/126 probe trip	1 = tripped, 0 = not tripped	R
25023	Drive type	0 = Standard, 1 = Legacy DC, 2 = Legacy AC	R
26001-26008	dsp mechanical machine positions for axes 1-8		R
26101-26108	dsp mechanical local positions for axes 1-8		R
26201-26208	local + travel limit position for axes 1-8		R
26301-26308	local - travel limit position for axes 1-8		R
26401-26404	Axis 1 reference points 1-4		R
26501-26504	Axis 2 reference points 1-4		R
26601-26604	Axis 3 reference points 1-4		R
26701-26704	Axis 4 reference points 1-4		R
26801-26804	Axis 5 reference points 1-4		R
26901-26904	Axis 6 reference points 1-4		R
27001-27004	Axis 7 reference points 1-4		R
27101-27104	Axis 8 reference points 1-4		R
27201-27208	ACDC drive estimated brake wattage for axes 1-8		R
29000-31999	User variables. These variables retain their values until the CNC software is exited.	Floating point value	R/W

Index	Description	Returns	R/W
50001-51312	PLC Inputs 1-1312	Jog Panel is on INP1057-1312	R
60001-61312	PLC Outputs 1-1312	Jog Panel is on OUT1057-1312	R
70001-71024	PLC Memory Bits 1-1024		R
80001-89999	Reserved		R
90001-90064	Timer 1-64 status bits		R
91001-91064	Reserved		R
92001-92064	Reserved		R
93001-93256	Stage 1-256 status bits		R
94001-94256	Fast Stage 1-256 status bits		R
95001-95256	Reserved		R
96001-96044	W1-W44 (32-bit signed integers)		R
97001-97022*	DW1-DW22 (64-bit signed integers)		R
98001-98044	FW1-FW44 (32-bit floats)		R
99001-99022	DFW1-DFW22 (64-bit floats)		R

* Since user or system variables are turned into (double) floating point values when referenced in an M- or G-code program, the 64-bit integer values lose precision when they exceed 2^{53} (9,007,199,254,740,992).

Examples:

```
#100 = #5041          ; set user variable #100 to the X axis current position
G90 X[#5041+1+7/32] ; move the X axis 1 7/32 units (1.2188) incrementally
#2501 = #5021        ; set WCS#1 X value to the current X position
#2703=[#2703+1/8]    ; add 1/8 units (.125) to the WCS#3 Z value

; Subroutine parameter and local variable access.
G1 X#A Y#B Z#C F#F    ; move to the coordinates passed as parameters
#[Q] = #F * .10       ; Assign local variable #Q to 10% of #F
#17 = #7 * .10        ; Same statement as previous using number references.
#[C] = 0.05           ; Reassign #C. (Value passed as parameter is lost.)
```

Advanced Macro Statements

NOTICE Branching and conditional execution are extremely powerful tools that, combined with access to system variables, allow you to do many things that would otherwise be impossible. Nevertheless, using branching and conditional execution can introduce undesirable and even unpredictable behavior into your programs. Undesirable effects can occur simply by graphing a program. The least of these undesirable effects could be entering an endless loop, failing to draw anything, or wiping out all the information in your tool library or WCS settings. It is your responsibility to make sure that undesirable things do not happen in your programs. You must monitor the job processing and search modes in your program, if necessary, and take appropriate action. Until you are confident of the actions of your program, you should step through it one block at a time to confirm your program logic.

GOTO - Branch Execution

To branch to another line within the same program or subprogram, use the statement:

GOTO <expression>

where <expression> is any expression that evaluates to a valid block number in the program. GOTO causes an immediate branch to the specified destination. Program codes preceding a GOTO on the same line will be executed normally. Any program codes following GOTO on the same line will cause an error.

If fast branching is disabled (parameter 145 = 0) then the CNC software searches forward in the program for the first matching block number and resumes searching, if necessary from the top of the program. For this reason when fast branching is disabled, backward branches take longer than forward branches and backward branch times depend on the total program size. If the program is sufficiently large, use of the GOTO statement could introduce temporary pauses.

When fast branching is enabled (parameter 145 = 1) then the CNC software remembers the locations of block numbers as it finds them during program execution. Backward branches always take place immediately. The first forward branch to a block not yet encountered will take additional time as the CNC software searches forward for the block number; however, subsequent forward branches to that block number will take place immediately. The trade-off for using fast branching is that all line numbers at a given level of program or subprogram must be unique and programs will use more memory (approximately 16kilobytes of memory for every 1000 block numbers in the program.)

IF THEN ELSE - Conditional Execution

Program symbols, G codes, M codes and GOTO commands may be executed conditionally using the IF statement. The general form of the IF statement is:

IF <expression> THEN <execute if true> ELSE <execute if false>

where <expression> is any valid expression, <execute if true> is one or more program codes to execute if <expression> evaluates to “true” (non-zero) and <execute if false> is one or more program codes to execute if <expression> evaluates to “false” (zero). All parts of the IF statement must appear on the same line. The “ELSE <execute if false>” part of the statement is optional and may be omitted. The “THEN” may be omitted; however, <expression> must be enclosed in brackets ([]). The IF statement may follow other program codes on the same line. Compound conditionals are possible but they cannot be nested. The first THEN always pairs with the first IF. ELSE always pairs with the first <expression> that evaluates to “false”. All program codes executed are executed as part of the same block.

Examples:

```
; Branch to N200 if machine position is okay, otherwise go to N300
N100 IF #5041 LE 5.0 THEN GOTO 200 ELSE GOTO 300
; Force subprogram parameter #D to be within range.
IF [#D LE 0.005] #[D] = 0.005
; Compound conditionals
IF [#A LE 0.0] GOTO 100 ELSE IF [#A LE 2.5] GOTO 200 ELSE GOTO 300
IF [#A GT 0.0] IF [#D/#A GE 0.0] #[C] = SQRT[#D/#A]
```

INPUT – Prompt Operator for Input

The INPUT macro prompts the operator for numeric input. The general form of the INPUT statement is:

```
INPUT "<prompt>" <variable>
```

Where <prompt> is the message prompt for the operator and <variable> is the variable in which to store the input. The CNC software will display a dialog with the given prompt and space for the operator response. The operator may enter any numeric expression (see above) including variables as a response. The operator must press **CYCLE START** or **Alt-S** to dismiss the dialog. Pressing **ESC** will cancel the job.

The CNC software parses well ahead of the current execution to maximize throughput and efficiency. For this reason, an INPUT macro may prompt the operator for input immediately even though the INPUT macro is located in the middle or near the end of the job. Parsing pauses while the dialog is displayed. Any statements parsed prior to the INPUT macro will have been queued and will continue to execute in the background while the prompt is displayed. Job processing will pause only if all queued statements have been executed before the operator supplies a response.

INPUT macros will not graph. If you must graph the job, first set the input variable to a default value and use a conditional to execute the INPUT only if the job is being run normally.

Use search mode cautiously with INPUT macros. To have search work properly, you may have to supply exactly the same input during the search as you did during the last actual run.

Examples:

```
; Ask operator for pocket depth. Store result in #101  
; Note: this will not graph.  
INPUT "Enter pocket depth" #101
```

```
; Allow job with INPUT statements to be graphed.  
#101 = 0.5; Supply a default value for graphing  
; Ask for operator input only if not graphing.  
IF NOT #4201 THEN INPUT "Enter pocket depth" #101
```

Chapter 12

CNC Program Codes: G-codes

G-code	Group	Description
G00	* A	Rapid Positioning
G01	A	Linear Interpolation
G02	A	Circular or Helical Interpolation CW
G03	A	Circular or Helical Interpolation CCW
G04	B	Dwell
G09	B	Decelerate and Stop (<i>formerly known as Exact Stop</i>)
G10	B	Parameter Setting
G17	* C	Circular Interpolation Plane Selection XY
G18	C	Circular Interpolation Plane Selection ZX
G19	C	Circular Interpolation Plane Selection YZ
G20	* K	Select Inch Units
G21	K	Select Metric Units
G22	O	Work envelope on
G23	* O	Work envelope off
G28	B	Return to Reference Point
G29	B	Return from Reference Point
G30	B	Return to Secondary Reference Point
G40	* D	Cutter Compensation Cancel
G41	D	Cutter Compensation Left
G42	D	Cutter Compensation Right
G43	E	Tool Length Compensation (+)
G43.3	E	Tool Length Compensation (+) with Axis Tilt Compensation
G44	E	Tool Length Compensation (-)
G49	* E	Tool Length Compensation Cancel
G50	* M	Scaling/Mirroring Off (Optional)
G51	M	Scaling/Mirroring On (Optional)
G52	B	Offset Local Coordinate System Origin
G53	B	Rapid Position in Machine Coordinates
G54	L	Select Work Coordinate System #1
G55	L	Select Work Coordinate System #2
G56	L	Select Work Coordinate System #3
G57	L	Select Work Coordinate System #4
G58	L	Select Work Coordinate System #5
G59	L	Select Work Coordinate System #6
G61	F	Modal Decel and Stop (<i>formerly known as Exact Stop Mode</i>)
G64	* F	Smoothing mode selection / Cancel Modal Decelerate and Stop
G65	J	Call Macro
G68	N	Coordinate Rotation on
G69	* N	Coordinate Rotation off
G73	G	High Speed Peck Drilling
G74	G	Counter Tapping
G76	G	Fine Bore Cycle
G80	* G	Canned Cycle Cancel

G81	G	Drilling and Spot Drilling
G82	G	Drill with Dwell
G83	G	Deep Hole Drilling
G84	G	Tapping
G85	G	Boring
G89	G	Boring with Dwell
G90	* H	Absolute Positioning Mode
G91	H	Incremental positioning Mode
G92	B	Set Absolute position
G93	P	Inverse Time On
G93.1	P	Velocity Scrubber for Smoothed Inverse Time Data
G94	P	Inverse Time Off
G98	* I	Initial Point Return
G99	I	R Point Return
G117	C	Rotation of Plane Selection XY
G118	C	Rotation of Plane Selection ZX
G119	C	Rotation of Plane Selection YZ
G173	G	Compound High Speed Peck Drilling
G174	G	Compound Counter Tapping
G176	G	Compound Fine Bore Cycle
G180	G	Compound Canned Cycle Cancel
G181	G	Compound Drilling and Spot Drilling
G182	G	Compound Drill with Dwell
G183	G	Compound Deep Hole Drilling
G184	G	Compound Tapping
G185	G	Compound Boring
G189	G	Compound Boring with Dwell

NOTES:

- All the default G-codes have been marked with the symbol " * ".
- A given line of a program may contain more than one G-code.
- If several G-codes from one group are used in the same line, only the G-code specified last will remain active.
- G-codes from group B are of "one shot" type (active only in the line in which they are specified). All other G-codes are modal (active until another G-code of the same group is specified).
- If a G-code from group A is used in a canned cycle mode, the canned cycle will be canceled. Canned cycle G-codes, however, have no effect on G-codes from group A.

G00 - Rapid Positioning

G0 moves to the specified position at the maximum motor rate. The coordinates may be either absolute positions (G90) or incremental positions (G91). G0 is modal and remains in effect until another positioning mode (G1, G2, G3 etc.) is commanded. G0 is the default-positioning mode.

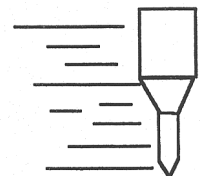

When the Z axis is commanded to move in the + direction, the Z axis will move up to its new position first, then the other axes will move to their new position along a straight line.

When the Z axis is commanded to move in the - direction, all axes but the Z axis will move to their new position along a straight line, then the Z axis will move down to its new position.

Example:

```
G0 X0.0 Y0.0 Z0.0 ; Rapid move to X0, Y0, Z0
```



CAUTION

The feedrate override knob has no effect on G0 moves unless rapid override is turned ON

G01 - Linear Interpolation

G1 moves to the specified position at the programmed feedrate. The coordinates may be either absolute positions (G90) or incremental positions (G91). The movement will be along a straight line. G1 is modal and remains in effect until another positioning mode (G0, G2, G3 etc.) is commanded.

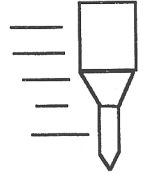

Example:

```
G01 X2 Y3 Z4 W5 F10 ; Linear move to X2, Y3, Z4, W5 at a 10in/min
G91 X6 Y7 ; Linear move to X8, Y10
Z3 W4 F20 ; Linear move to Z7, W9 at 20in/min (G91 is modal)
```

G02 & G03 - Circular or Helical Interpolation

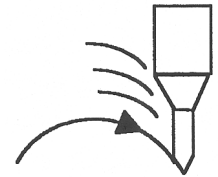

G2 moves in a clockwise circular motion, and G3 moves in a counterclockwise circular motion. This clockwise and counterclockwise motion is relative to your point of view, however. See the diagram below. The X, Y or Z position specified in the G2 or G3 command is the end position of the arc, and may be an absolute position (G90) or an incremental position (G91). G2 and G3 are modal and remain in effect until another positioning mode (G0, G1, etc.) is commanded.

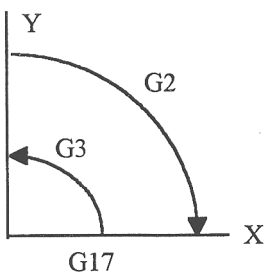

View facing machine looking Z-

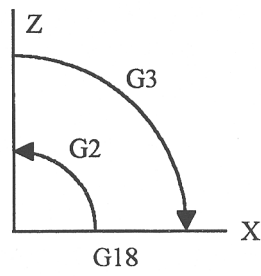

View facing machine looking Y+

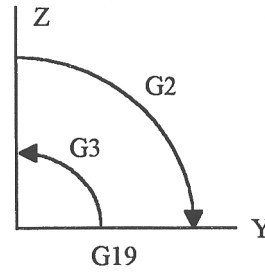

View facing machine looking X-

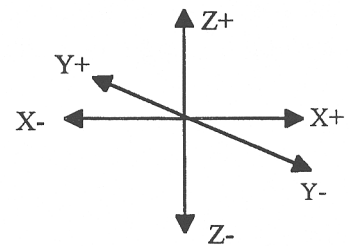

*** NOTE:** When using G18, the G2 command moves in a counterclockwise direction in the XZ plane.

The axes included in the currently selected circular plane (G17, G18, or G19) will move in a circular motion. Any other axes specified will move along a straight line (helical movement). The programmed feedrate is used for the interpolated motion along the movement of all axes.

Helical and circular motion can be programmed in two different ways: specifying the final point and the radius of the arc, or specifying the final point and the parameters I, J, K (center point of the arc as incremental values from the start position).

* NOTE: For closed circles (arc of 360 degrees), use method 2: specify final point and parameters I, J and K. Method 1 (specify final point and radius) will not work.

METHOD 1: USING FINAL POINT AND RADIUS

The commands G2 and G3 will have the following structure:

```
G2 Xa Yb Zc Rd
G3 Xa Yb Zc Rd
```

where a , b , and c will be the X, Y, and Z coordinates of the final point of the arc, and d will be the radius. In most cases there will be two possible arcs of the same radius connecting two given points. This occurs because the center of the arc is not specified. To choose the bigger arc, make the radius negative. To choose the smaller arc, make the radius positive. See examples 1 and 2 for graphical explanations of this concept.

Example 1 (small arc solution: positive radius):

```
G17 G90 F25           ; selects XY plane and absolute positioning
G00 X1.0 Y1.0 Z0      ; rapid to start position X1, Y1, Z0
G02 X2 Y2 Z0 R1       ; arc to X2 Y2 Z0 with radius of 1
                       ; (small arc solution)
```

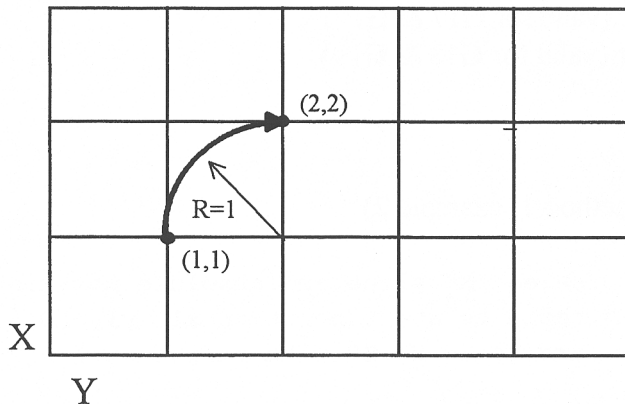

Example 2 (big arc solution: negative radius):

```
G17 G90 F25           ; selects XY plane and absolute positioning
G00 X1.0 Y1.0 Z0      ; rapid to start position X1, Y1, Z0
G02 X2 Y2 Z0 R -1     ; arc to X2 Y2 Z0 with radius of 1
                       ; (big arc solution)
```

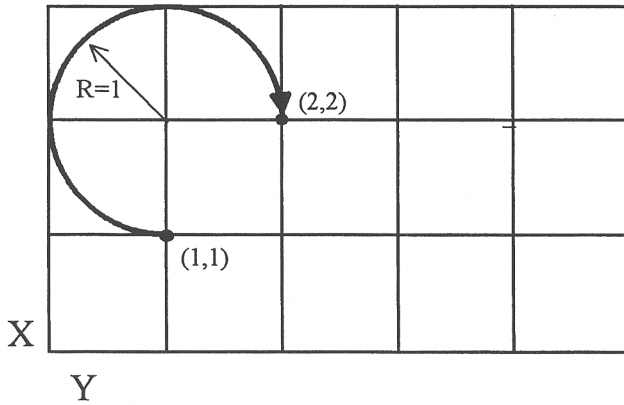

METHOD 2: USING FINAL POINT AND PARAMETERS I, J, K

Another way to specify a helical or circular operation is using the parameters I, J, K instead of the radius R. The parameters I, J, and K are the **incremental** distances from the start point to the center of the arc. For absolute positioning on I, J, and K, parameter 2 bit 0 will need set. See the parameter section in Chapter 14.

I = X center - X start (valid for G17 & G18)

J = Y center - Y start (valid for G17 & G19)

K = Z center - Z start (valid for G18 & G19)

Examples:

Circular motion (See graph in method 1, example 2)

```
G17 G90 F25           ; selects XY plane and absolute positioning
G00 X1.0 Y1.0 Z0     ; rapid to start position X1, Y1, Z0
G02 X2 Y2 Z0 J1      ; arc to X2 Y2 Z0 with radius of 1
```

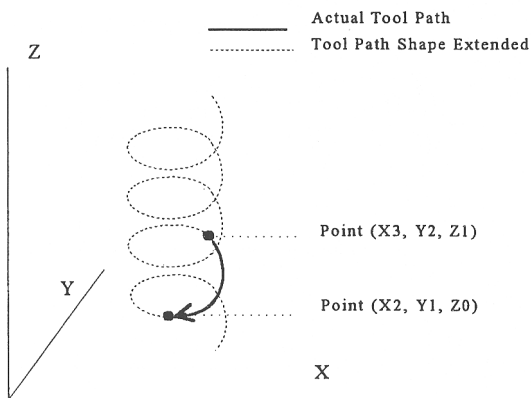

Helical motion

```
G17 G90 F30           ; select XY plane and absolute positioning
G00 X3.0 Y2.0 Z1.0   ; rapid to start position X3, Y2, Z1
G02 X2.0 Y1.0 I-1.0 J0.0 Z0.0 ; CW XY arc from X3, Y2 to X2, Y1.
                        ; Center at X2, Y2
                        ; Helical Z move from 1 to 0
```

G04 - Dwell

G4 causes motion to stop for the specified time. The P parameter is used to specify the time in seconds to delay. G4 causes the block to decelerate to a full stop.

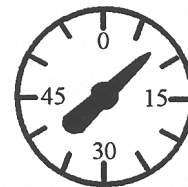

The minimum delay is 0.01 seconds and the maximum is 327.67 seconds. The dwell time is performed after all motion is stopped and M functions on the line are completed. If the P parameter is not specified, X will be used instead. If neither P nor X is specified, the default dwell time of 0.01 seconds will be used.

Example:

```
G0 X1 Y1           ; rapid to X1, Y1
G4 P2.51           ; pause for 2.51 seconds
G1 X2 Y2           ; Linear move to X2, Y2
```

G09 - Decelerate and Stop (formerly known as Exact Stop)

G9 causes motion to decelerate to a stop and dwell for 1/100 seconds. G9 is equivalent to G4 P0.01. G9 is not modal; it is only effective for the block in which it appears. See G61 (Modal Decelerate and Stop).

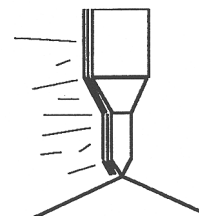

Example:

```
G9 G0 X1 Y1       ; rapid to X1 Y1 and stop
X2 Y2             ; continue to X2 Y2
```

G10 - Parameter Setting

G10 allows you to set parameters for different program operations.

Examples:

```
G10 P73 R.05      ; Sets the peck drilling retract amount to .05
G10 P83 R.05      ; Sets the deep drill rapid down clearance to .05
G10 P81 R15       ; Sets G81 to use M15 instead of Z movement
G10 H5 R-1.3      ; Sets tool length offset #5 to -1.3 in the offset lib.
G10 D3 R.25       ; Sets tool diameter offset #3 to .25 in the offset lib.
```

G17, G18, G19 - Circular Interpolation Plane Selection

G17, G18, and G19 select the plane for circular interpolation commands (G02 & G03). G17 is the default plane. See figure under G2 and G3.

G17 is the XY plane
G18 is the ZX plane
G19 is the YZ plane

G20 - Select Inch Units

G20 selects inch units, affecting the interpretation of all subsequent dimensions and feedrates in the job file. G20 does not change the native machine units as set on the control setup menu.

G21 - Select Metric Units

G21 selects metric units, affecting the interpretation of all subsequent dimensions and feedrates in the job file. G21 does not change the native machine units, as set on the control setup menu.

G22/G23 – Work Envelope On/Off

G22 turns on programmable work envelope in machine coordinates. When the machine tries to move into the forbidden area, let's say the x-axis, an "x-axis work envelope exceeded" message is displayed, letting you know which line of the program is at fault. The work envelope is set with the X, Y, Z for the '+' limit and I, J, K for the '-' limit. G22 is modal and remains on until turned off by G23 or the end of the job. The limits entered in the X, Y, Z and I, J, K parameters are stored in the WCS menu under **F3 - Work Envel**. For more information see chapter 4.

Example: (Machine homes to the X + switch and has 0 to -40 inches of travel in the X axis,)

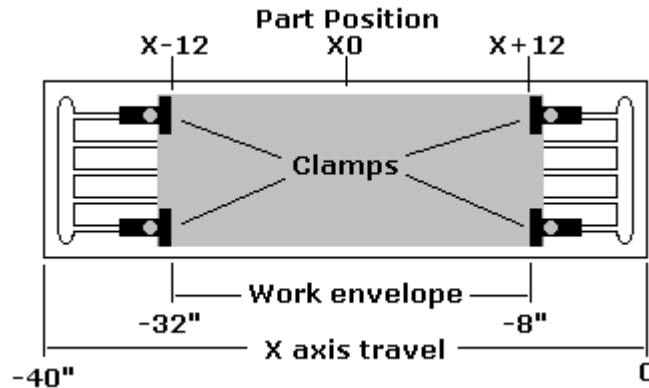

```
G22 X-8 I-32 ; Keeps programs from moving into the outside 8 inches of X-  
; axis of travel  
G1 X-13 F20 ; Would generate a "X axis work envelope exceeded, line 3"  
; message  
G23 ; Allows travel into G22 forbidden area.  
M25 ; Z home  
G0 X-13 ; Ok to move X here now
```

G28 - Return to Reference Point

G28 moves to the first reference point, by way of an intermediate point. The location of the reference point, in machine coordinates, may be set in Work Coordinate System Configuration. The intermediate point is specified in the local coordinate system, and may be at the current location (resulting in a move directly to the reference point). If an intermediate point is specified, only those axes for which positions are specified will be moved. If no axes are specified, all axes will be moved. The location of the intermediate point is stored for later use with G29.

Examples:

```
G28 G91 Z0 ; move Z-axis directly to reference point  
; ( X and Y don't move)  
G28 G91 X-.5 Y0 Z0 ; move X -0.5 (from current position), then move all  
; three axes to reference point  
G28 G90 X2 Y4 Z.1 ; move all axes to (X2, Y4, Z0.1), then to  
; reference point  
G28 ; move all axes to the reference point  
; ( no intermediate point)
```

* NOTE: As with G0 positioning moves, the Z-axis will move separately. If Z is moving up (the usual case) Z will move first, then the other axes. If Z is moving down, the other axes will move first, then Z. Because of this, it is rarely necessary to specify an intermediate point different from the current position.

G29 - Return from Reference Point

G29 moves all axes to the intermediate point stored in a preceding G28 or G30 command. It may be used to return to the work piece. If a position is specified, the machine will move to that position (in local coordinates) after reaching the intermediate point. G29 may only be specified after G28 or G30, though there may be intervening moves.

Examples:

```
G29                ; move all axes back from reference point to intermediate
                  ; point

G29 X1 Y2          ; move all axes to intermediate point, then move to X1 Y2
```

* NOTE: As with G0 positioning moves, the Z-axis will move separately. If Z is moving up, Z will move first, then the other axes. If Z is moving down (the usual case for G29), the other axes will move first, then Z will move.

G30 - Return to Secondary Reference Point

G30 functions exactly like G28, except that by default it uses the second reference point from the Work Coordinate System Configuration table, and the P parameter may be used to request either reference point.

Examples:

```
G30 G91 Z0        ; move Z axis directly to second reference point

G30 P1            ; move all axes to first reference point
```

NOTE: G30 P1 is equivalent to G28.

G40, G41, G42 -Cutter Compensation

G41 and G42 in conjunction with the selected tool diameter (D code) apply cutter compensation to the programmed tool path.

G41 offsets the cutter tool one half of the tool diameter selected with a D code, to the left of the work piece, relative to the direction of travel.

G42 offsets the cutter tool one half of the tool diameter selected with a D code, to the right of the work piece, relative to the direction of travel.

G40 cancels G41 and G42.

Example:

```
G41 D03           ; Tells the machine to compensate left half of the
                  ; diameter of the amount that corresponds to D03 in the
                  ; Tool Library
```

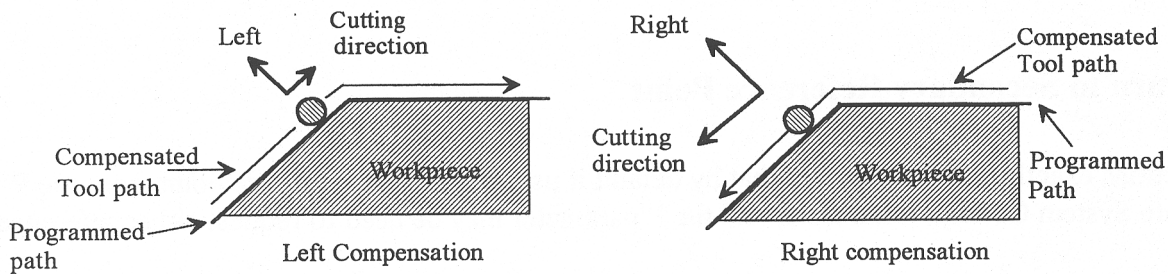

Whenever cutter compensation is applied, the following factors must be taken into account in order to obtain proper results.

1. The cutter diameter compensation function (G41, G42) must be implemented before the cutter tool reaches the starting cutting point.

Example 1:

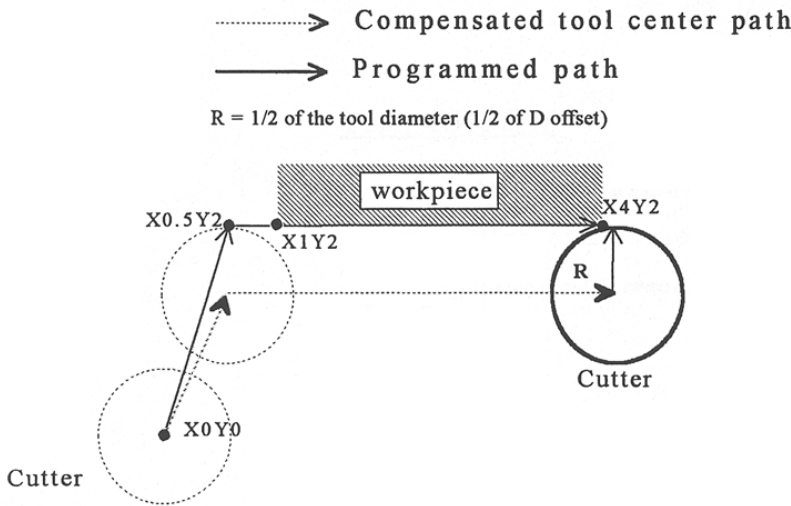

```

G0X0Y0      ; Rapid tool to X0, Y0
G42 D3      ; Turn cutter compensation on, with a diameter of D3
G0X.5Y2     ; Rapid to X0.5, Y2
G1x4.1Y2    ; Linear cut to X4.1, Y2.
             ; Cut to X4.1 to clear material.
G40         ; Turn cutter compensation off.
G0X5Y0      ; Rapid to X5, Y0.

```

You may want to add .1 or .05 inches on the final position for the last cut to clear the material.

NOTE: The diameter compensation statement G42 is placed before G0 X.5 Y2. As a result, the compensation is applied before the cutter reaches the starting cutting point X.5 Y2.

2. If the cutter is down, then the cutter compensation lead-in must always come from an appropriate direction. Otherwise, the work piece will be incorrectly cut, and the cutter tool could be damaged. One way to avoid this problem is by always keeping the cutter above the work piece whenever a transition is being made to a new starting cutting point. If for some reason this was not possible, then the G-code program should be written so that the cutter compensation lead-in paths do not interfere with the space occupied by the work piece. Example 2 illustrates a possible harmful outcome of programming an inappropriate lead-in direction.

Example 2:

WRONG WAY

.....> Compensated tool center path

————> Programmed path

R = 1/2 of the tool diameter (1/2 of D offset)

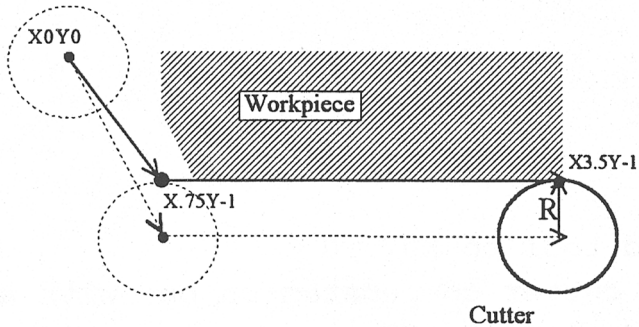

```
G0 X0Y0           ; Rapid tool to X0, Y0
G42 D5            ; Turn cutter compensation on, with a diameter of D5
G1 X.75Y-1 F5     ; Linear move to X0.75, Y-1. (Notice this damages the
                  ; corner of the work piece)
X3.6              ; move X to 3.6
G40               ; Turn cutter compensation off.
G0 X4Y-2          ; Rapid to X4, Y-2
```

* NOTE: This problem could have been avoided by selecting a transitional point between X0 Y0 and X.75 Y-1. A transitional point such as X-1 Y-1 would properly modify the lead-in path, keeping the cutter from damaging the corner of the work piece. Example 3 shows the correct way of performing this operation.

Example 3:

CORRECT WAY

.....> Compensated tool center path

————> Programmed path

R = 1/2 of the tool diameter (1/2 of D offset)

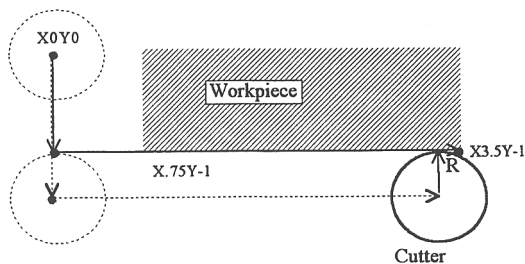

```

G0X0Y0           ; Rapid tool to X0, Y0
G42D5           ; Turn cutter compensation on, with a diameter of D5
G0X0Y-1        ; Rapid tool to X0, Y-1
G1X.75Y-1      ; Linear cut to X0.75, Y-1.
X3.6           ; move X to 3.6
G40            ; Turn cutter compensation off.

```

3. *Lookahead*. When the control machines any rapid traverse (G0), line (G1), or arc (G2, G3) with tool diameter compensation enabled, the program will look up to N consecutive events ahead of the current event in order to anticipate tool path clearance problems, where N is the number set in Parameter 99. Lookahead ensures that compensated tool paths don't overlap in programmed part sections where there is not enough clearance for the tool. The figure below shows a compensated tool path, and the actual tool path after Lookahead corrects the clearance problem:

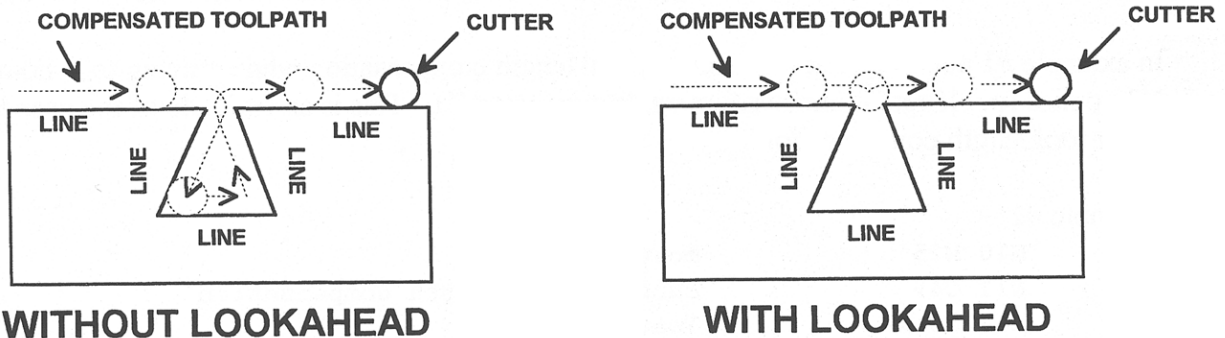

Refer to the “Machine Parameters” section in Chapter 14 for more information on Parameter 99.

G43, G44, G49 - Tool Length Compensation

G43 and G44 apply tool length compensation to a selected tool to allow the control to utilize multiple tools in a single CNC program.

G43 applies positive compensation (from Z zero up). Work from part surface up.

G44 applies negative compensation (from Z zero down), used only when there is an absolute machine home. The spindle face is considered a zero length tool and all offsets are from there down.

G49 cancels tool length compensation (also canceled by issuing G43 H00).

Example:

```

G43 H01         ; tells the machine to offset the amount that
                ; corresponds to H01 in the Offset Library

```

G43.3 - Tool Length Compensation (+) with Axis Tilt Compensation

G43.3 is a special compensation mode which applies positive tool length compensation on a selected tool, just like G43, but also with additional X and Z compensations due to 5th axis tilt. This compensation mode is available only on those machines configured with a triangular rotary 5th axis (see parameter 166 in Chapter 14). Note that this compensation mode is the equivalent to G43 as long as the 5th axis is not tilted (i.e. local position is 0). G49 cancels this compensation mode.

G50, G51 - Scaling / Mirroring (Optional)

G50 and G51 scales program G-codes relative to a scaling center point defined as position (X, Y, Z).

A G51 applies scaling/mirror to all positions, lines, and arcs following this G-code, until a G50 is entered. Specify scaling factors with a value I, J, K. The X, Y, and Z parameters are the coordinates of the scaling center. If the scaling center is not specified, the default scaling center is the current cutter position as shown on the DRO. To mirror, enter a negative value for the scaling factor.

Example, Scaling:

```
G51 X0.0 Y0.0 Z0.0 I3.0 J2 K1 ; turn scaling on
G00 X0.0 Y0.0 Z1.0 ; rapid to X0, Y0, Z1
G01 X1.0 Y0.0 Z1.0 ; line to X1, Y0, Z1
G01 X1.0 Y1.0 Z1.0 ; line to X1, Y1, Z1
G01 X0.0 Y1.0 Z1.0 ; line to X0, Y1, Z1
G01 X0.0 Y0.0 Z1.0 ; line to X0, Y0, Z1
G01 X0.0 Y0.0 Z0.0 ; line to X0, Y0, Z0
G50 ; cancel scale
```

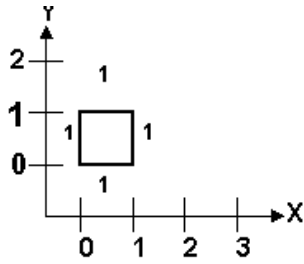

Original Box

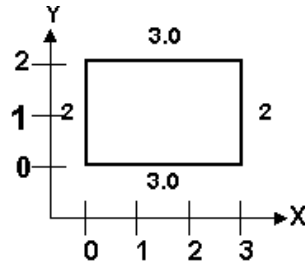

Scaled Box

For this G51, the following program lines were scaled 3:1 in the X direction, 2:1 in the Y direction, and 1:1 in the Z direction. If no scale factor is specified, the default is 1:1 for all axes.

Example, Mirroring:

```
G51 X-0.5 Y0.0 Z.0 I-1 J1 K1 ; turn mirror on (x axis -0.5 mirror
; line)
G00 X0.0 Y0.0 Z1.0 ; rapid traverse to X0, Y0, Z1
G01 X1.0 Y0.5 Z1.0 ; line to X1, Y.5, Z1
G01 X0.0 Y1.0 Z1.0 ; line to X0, Y1, Z1
G01 X0.0 Y0.0 Z1.0 ; line to X0, Y0, Z1
G50 ; cancel mirror
```

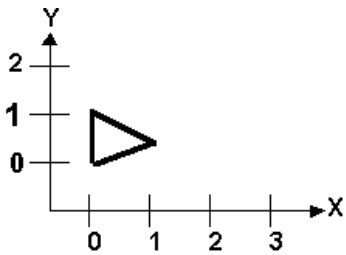

Original Triangle

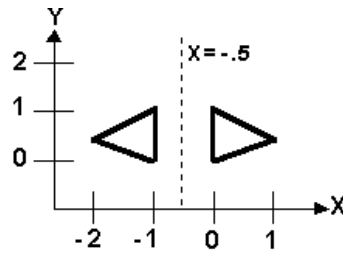

Mirrored Triangle

If scaling factors are the same for all the axes, parameter P can be used.

Example:

```
G51 X1.0 Y2.0 Z0.0 P2.5 ; scale all axes a factor of 2.5.
```

If an arc is scaled with uneven scaling factors, the result will depend on how the arc center and radius were specified:

1. If the arc radius was specified with R, the radius will be scaled by the larger of the two circular plane scale factors. The result will be a circular arc between the scaled arc start and the scaled arc end.
2. If the arc center was specified with I, J, and/or K, the centers will be scaled by the appropriate axis scale factors. The result will be a circular arc from the scaled arc start, around the scaled center, and usually with a line from the end of the circular arc to the scaled arc end.
3. In no case can an ellipse be generated using scaling.

G52 - Offset Local Coordinate System

G52 shifts the local coordinate system origin by a specified distance. Multiple G52 codes are not cumulative; subsequent shifts replace earlier ones. The G52 shift may therefore be canceled by specifying a shift of zero. If you are using multiple coordinate systems, the G52 shift amount will affect all coordinate systems.

Example:

```
G0 X0 Y0           ; move to origin
M98 P9100          ; call subprogram
G52 Y4             ; shift coordinate system 4 inches in Y
G0 X0 Y0           ; move to new origin
M98 P9100          ; call subprogram again with new coordinates
G52 Y0             ; restore unshifted coordinate system
```

G53 - Rapid Positioning in Machine Coordinates

G53 is a one shot code that performs a rapid traverse using machine coordinates. It does not affect the current movement mode (G0-G3) or coordinate system (G54-G59). G53 may only be used with absolute positioning (G90).

Example:

```
G53 X15 Y4 Z0      ; move to 15,4,0 in machine coordinates
```

G54 - G59 - Select Work Coordinate System

G54 through G59 select among the six regular work coordinate systems (WCS #1 through WCS #6). After issuing the code, subsequent absolute positions will be interpreted in the new coordinate system. Alternatively, the codes E1 through E6 to can be used instead of G54 through G59.

Example:

```
G54 G0 X0 Y0 Z0    ; select first WCS, move to origin
G2 X1 I.5 Z-.5     ; mill something...
G0 Z.1             ; Rapid to position Z0.1
G55 X1 Y1          ; select second WCS, move to X1, Y1
```

Using Extended Work Coordinate Systems (optional): There are 12 additional work coordinate systems available as an extra-cost option. In a G-code program, these 12 additional work piece origins may be selected with either “G54 P1” (WCS # 7) through “G54 P12” (WCS #18) or “E7” through “E18.”

Regular WCS

WCS	G-Code	E Code
WCS #1	G54	E1
WCS #2	G55	E2
WCS #3	G56	E3
WCS #4	G57	E4
WCS #5	G58	E5
WCS #6	G59	E6

Extended Work Coordinate Systems (optional)

WCS	G-Code	E Code
WCS #7	G54 P1	E7
WCS #8	G54 P2	E8
WCS #9	G54 P3	E9
WCS #10	G54 P4	E10
WCS #11	G54 P5	E11
WCS #12	G54 P6	E12

WCS	G-Code	E Code
WCS #13	G54 P7	E13
WCS #14	G54 P8	E14
WCS #15	G54 P9	E15
WCS #16	G54 P10	E16
WCS #17	G54 P11	E17
WCS #18	G54 P12	E18

G61 - Modal Decelerate and Stop (formerly known as Exact Stop Mode)

G61 activates Decelerate and Stop mode for every block processed. This forces motion to decelerate to a stop and invokes a brief dwell (1/100 seconds) at the end of each block (equivalent to G9 in each block). G61 is modal and remains in effect until it is canceled with G64. Note that G61 also turns off Smoothing mode.

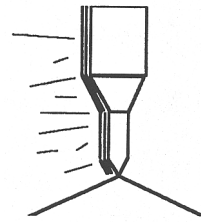

Example:

```
G0 X0 Y0           ; move to origin
G61 X2             ; move and decelerate and stop at X2
X4                 ; move and decelerate and stop at X4
X5                 ; move and decelerate and stop at X5
```

G64 – Smoothing Mode Selection / Cancel Modal Decel and Stop

Invoking G64 with either an ON or OFF parameter sets the Smoothing mode to on or off, and also cancels Modal Decelerate and Stop (G61). Invoking G64 without either the ON or OFF parameter simply cancels Modal Decelerate and Stop. G64 always cancels G61 no matter what optional parameters appear with G64.

The initial on/off state of Smoothing (i.e. at the beginning of a G-code program) is determined by parameter 220. The Smoothing on/off modal state can be changed using a G64 with an ON or OFF parameter and this will be in effect for the rest of the job or until another G64 ON/OFF is encountered. Upon job restart, the initial on/off state of Smoothing will once again be determined by parameter 220.

G64 Parameters	Function
(none)	Cancel Modal Decelerate and Stop (Cancel G61)
ON	Turn on Smoothing mode and also cancel Modal Decelerate and Stop.
OFF	Turn off Smoothing mode and also cancel Modal Decelerate and Stop.

Examples:

```
G64           ;no optional parameters - only cancel Modal Decelerate and Stop
G64 ON       ;turn on modal Smoothing mode (and cancel Modal Decel and Stop)
G64 OFF      ;turn off modal Smoothing mode (and cancel Modal Decel and Stop)
```

G65 - Call Macro

G65 calls a macro with user-specified values. A macro is a subprogram that executes a certain operation (e.g. drill pattern, contours, etc.) with values assigned to variable parameters within the operation.

Calling methods:

G65 Pxxxx Lrrr Arguments

or

G65 "program.cnc" Lrrr Arguments

where *xxxx* is the macro number (referring to file O*xxxx*.cnc, 0000-9999 allowed, leading zeros required in filename, capital O, lowercase .cnc), *rrrr* is the repeat value, "program.cnc" is the name of the macro file, and *Arguments* is a list of variable identifiers and values.

Arguments to macro calls are specified by using letters A-Z, excluding G, L, N, O, and P.

Macros are written just like normal programs. However, macro programs may access their arguments by using #A, #B, etc., or by using numbers: #1 for A, #2 for B, etc. (exceptions: #4-6 for I-K, #7-11 for D-H). Arguments I, J, and K can be used more than once in a macro call, with the first set of values stored as #4-6, the second as #7-9, etc., to a maximum of 10 sets. See example at the end of this G65 section.

Macros 9100 - 9999 may be embedded into a main program, using O91xx to designate the beginning of the macro and M99 to end it. The CNC software will read the macro and generate a file O91xx.cnc, but will not execute the macro. It will be executed when G65 is issued.

Example 1:

Main program:

```
G65 "TEST.cnc" A5 B3 X4
```

Macro TEST.cnc:

```
G1 X#X Y#A Z-#B
```

This call will produce

```
G1 X4 Y5 Z-3
```

Example 2:

Main program:

```
G65 "TEST2.cnc" I5 J3 K40 I-1 J2 I0 J0
```

Macro TEST2.cnc:

```
G1 X#4 Y#5 F#6
G1 X#7 Y#8 Z#9
G1 X#10 Y#11 Z#12
```

This call will produce

```
G1 X5 Y3 F40
G1 X-1 Y2 Z0
G1 X0 Y0 Z0
```

Example 3:

Suppose a piece is to have notches of different lengths and depths along the x-axis:

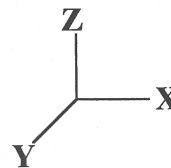
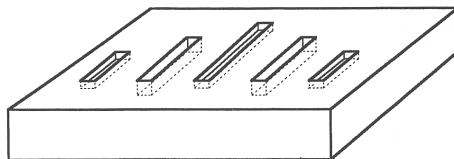
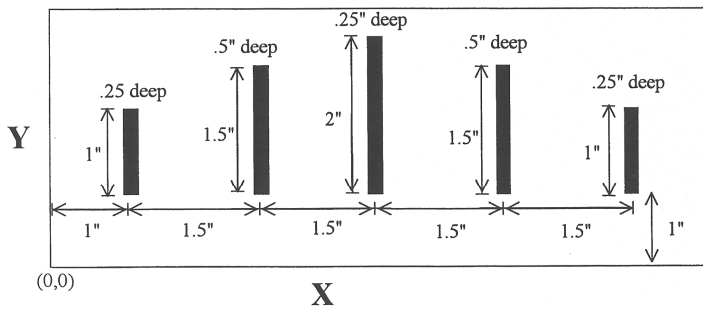

The macro variables would handle the length in the Y direction and depth in the Z direction:

```

O0002
G90 G1 Z0 F30           ; Linear move to Z0
Z#Z F5                 ; Cut to variable depth
G91Y#Y F10             ; Cut variable length
G90 G0 Z0.1           ; Retract

```

The main program would call this macro five times, each time specifying the depth and length required.

```

: Main Program
G90 G0 X1 Y1 Z0.1      ; Move to first notch
G65 P0002 L1 Y1 Z.25   ; Call macro and assign Y=1" and Z=.25"
G90 G0 X2.5 Y1        ; Move to second notch
G65 P0002 L1 Y1.5 Z.5 ; Call macro and assign Y=1.5" and Z=.5"
G90 G0 X4 Y1          ; Move to third notch
G65 P0002 L1 Y2 Z.25  ; Call macro again
G90 G0 X5.5 Y1       ; Move to fourth notch
G65 P0002 L1 Y1.5 Z.5 ; Call macro again
G90 G0 X7 Y1         ; Move to fifth notch
G65 P0002 L1 Y1 Z.25 ; Call macro again
: End program

```

G68, G69 - Coordinate Rotation on/off

G68 rotates program G-codes a specified angle R. G68 rotates all positions, lines, and arcs until a G69 is entered. The center of rotation can be specified by X, Y and Z values (X, Y for G17 plane). If the center is not specified then a default center of rotation is used as determined by machine parameter #2 (see Chapter 14 for parameter #2). The default plane of rotation is G17 (X, Y).

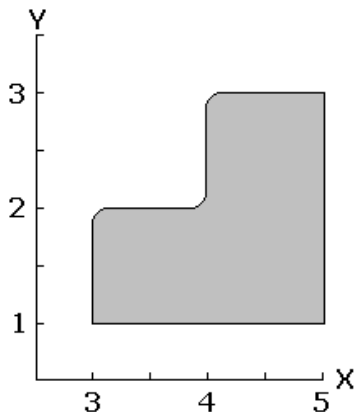

Original Unrotated Part

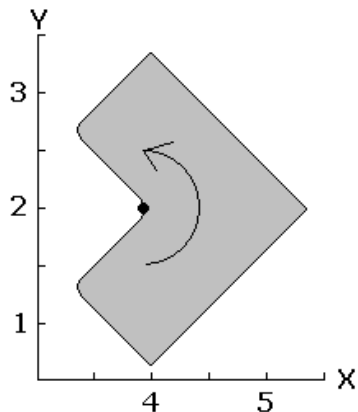

Part rotated 45° about X4, Y2

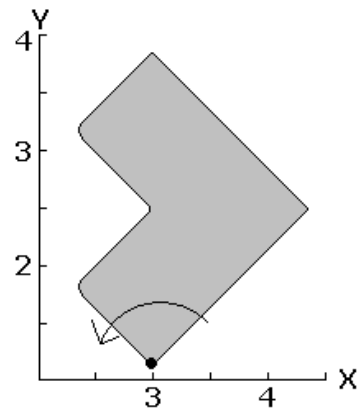

Part rotated 45° about X3, Y1

Example:

```

G68 R45 X4 Y2          ; Rotate 45 degrees centered on X4 Y2
G0 X3.0 Y1.0          ; Rapid to position
G1 X5.0 Y1.0 F20      ; Start part profile
X5.0 Y3.0
X4.125 Y3.0
G3 X4.0 Y2.875 J-0.125
G1 X4.0 Y2.125
G2 X3.875 Y2.0 I-0.125
G1 X3.125 Y2.0
G3 X3.0 Y1.875 J-0.125
G1 X3.0 Y1.0          ; End part profile
G69                   ; Rotate Off

```

G73, G76, G80, G81, G82, G83, G85, G89 - Canned Drilling/Boring Cycles G74, G84 - Canned Tapping Cycles

G code	-Z direction (machine hole)	Operation at bottom of hole	+Z direction	Use
G73	Intermittent Feed (Set with the Q parameter)	-----	Rapid traverse	High speed peck drilling cycle
G74	Feed	Spindle CW, then Dwell (Set with the P parameter)	Feed	Counter tapping (Left-hand thread)
G76	Feed	Dwell (P parameter), Orient Spindle (via M19), Move Y+ (Q parameter)	Rapid traverse, then Stop Spindle Orient (via M5)	Fine Boring Cycle
G80	-----	-----	-----	Cancel canned cycles
G81	Feed	-----	Rapid traverse	Regular and spot drilling cycles and air drill cycle
G82	Feed	Dwell (Set with the P parameter)	Rapid traverse	Regular and counter boring cycles, spot facing
G83	Intermittent Feed (Set with the Q parameter)	-----	Rapid traverse	Peck and deep hole drilling cycles
G84	Feed	Spindle CCW, then Dwell (Set with the P parameter)	Feed	Tapping (Right-hand thread)
G85	Feed	-----	Feed	Boring cycle
G89	Feed	Dwell (Set with the P parameter)	Feed	Boring cycle

Table 1. Canned drilling, boring and tapping cycles

Canned Cycle Operation

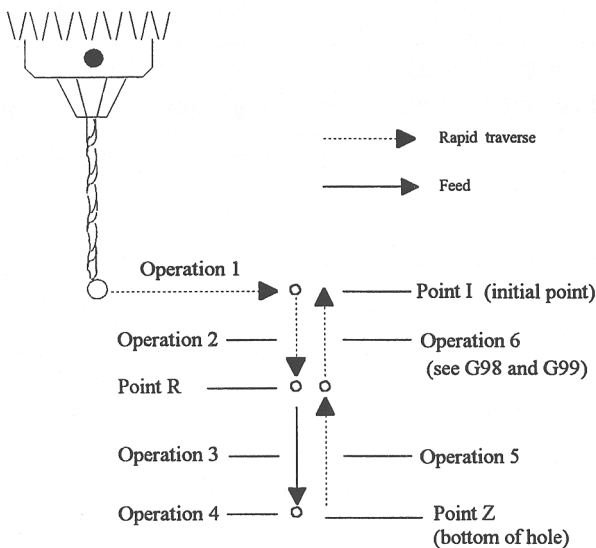

Figure 1. Drilling cycle operation

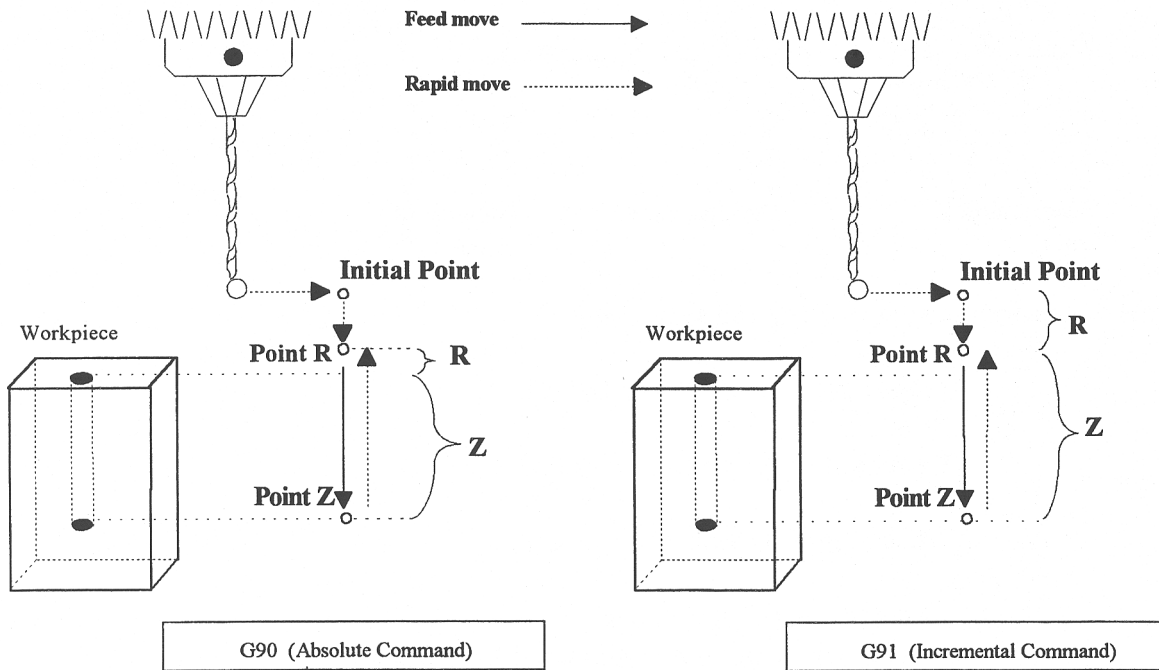

Figure 2: Canned Cycle Absolute and Incremental modes

* NOTE: In incremental mode the Z depth of the hole is measured from R, and R is measured from the initial tool position.

Example:

(Part surface height is Z = 0, initial tool position is X.50 Y1.0 Z.625. Drill 0.50 deep hole at X1.0 Y1.0; clearance height (R) is 0.10 above surface.)

Absolute

G90
G81 X1 Y1 R.1 Z-.5
G80

Incremental

G91
G81 X.5 Y0 R-.525 Z-.6
G80

* NOTE for Articulated Head machines configured with the TWCS feature enabled via Parameter 166: If the currently selected WCS is non-TWCS (TWCS = No) and the B axis is at an angle other than 0, then you cannot use the regular Canned Cycle G-codes G73, G74, G76, G81, G82, G83, G84, G85, G89. You must use the Compound Canned Cycle G-codes G173, G174, G176, G181, G182, G183, G184, G185, G189 instead. Using regular Canned Cycle G-codes when the B axis is not 0 is an error and will cancel the job. See “G173, G174... – Compound Canned Cycles” later in this chapter for more information about this subject. See Chapter 14 for more information about Parameter 166.

G73 - High Speed Peck Drilling

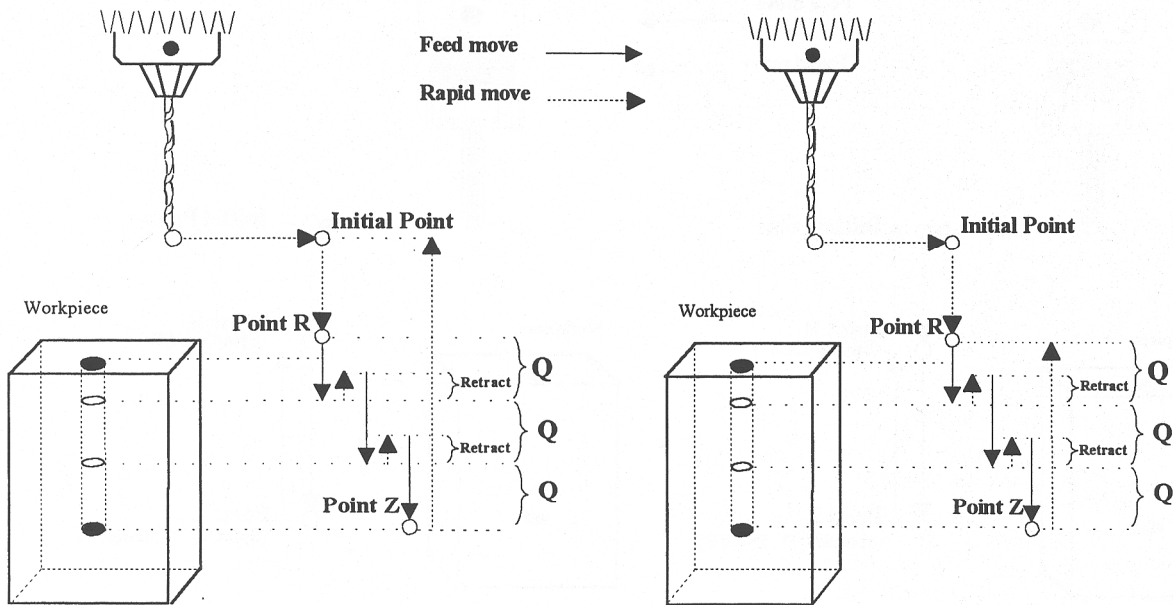

G73 using G98

G73 using G99

G73 is the peck drilling cycle. The hole is drilled in a series of moves: down a distance Q at a given feedrate, up the retract distance at the rapid rate, and then down again at the given feedrate. The retract amount is set with G10 as shown in the example below.

Example:

```

G90 ; Absolute positioning
G01 X3.00 Y1.50 Z.5 ; G01 mode before canned cycle
G98 ; Set for initial point return
G10 P73 R.1 ; Sets the retract amount to .1
G73 X3.250 Y1.75 Z-.650 R.1 Q0.325 F3 ; Peck drill at X3.25 Y1.75
X4.5 Y3.5 ; Peck drill at X4.5 Y3.5
G80 ; Cancel canned cycle, return
; to G01
    
```

G74 - Counter Tapping

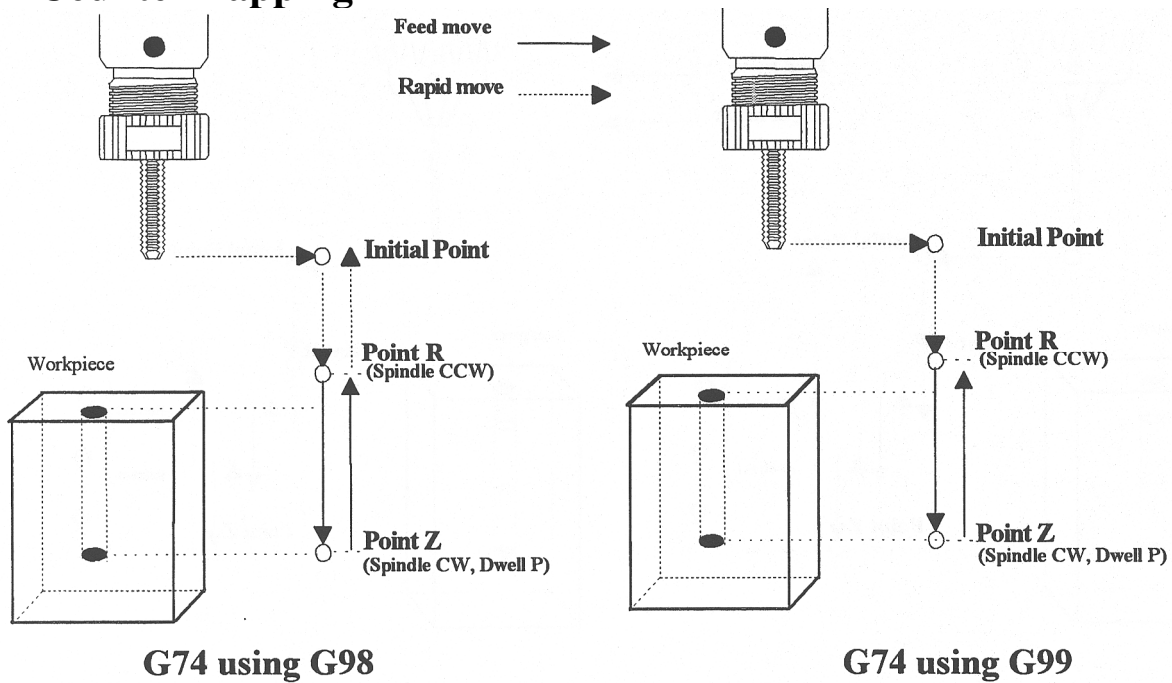

G74 performs left-hand tapping. The spindle speed (and feedrate, if you are doing floating tapping) should be set and the spindle started in the CCW direction before issuing G74. G74 will normally use the default M3 to select spindle CW (at the bottom of the hole) and M4 to re-select spindle CCW (after backing out of the hole) depending on the settings of parameters 74 and 84.

The tap may continue to cut a short distance beyond the programmed Z height as the spindle comes to a stop before reversing. When tapping blind holes, be sure to specify a Z height slightly above the bottom of the hole to prevent the tool from reaching bottom before the spindle stops.

Note: If rigid tapping is enabled, a Q may be used to set the thread lead or pitch. However, because Q is not modal in the case of Rigid Tapping, you must specify Q on every line at which Rigid Tapping is to occur.

Note: At the bottom of the hole, G74 will call the default version of the specified M function even if it has been customized by an M function macro.



WARNING FEED HOLD is temporarily disabled during the tapping cycle, but it will be re-enabled at the end of the cycle.

NOTICE Pressing CYCLE CANCEL while the tap is in the hole will very probably break the tap or strip the threads in the tap hole. However, do so if it is an emergency.

Example:

```

M4 S500 F27.78           ; start spindle CCW, set up for 18 pitch tap
G74 X1 Y1 R.1 Z-.5      ; counter-tap a 0.5 deep hole at X1 Y1
Y1.5                    ; ... and another one at X1 Y1.5
G80                      ; cancel canned cycles
    
```

G76 – Fine Bore Cycle

WARNING!!! G76 requires that the machine be capable of orienting the spindle and that a custom M19 macro is present in order to command the inverter to orient the spindle. Please contact your dealer to confirm that your machine meets these requirements before attempting to use this cycle.

Format G76 X__ Y__ Z__ R__ Q__

R = Point R Q = Distance to pull away from wall in Y+ direction at bottom of hole.

Example :

```
G76 X1 Y1 Z-3 R.1 Q.2      ; Bore hole at X1 Y1 retract .2 in Y+ direction
Y10                       ; ... and another one at X1 Y10
G80                       ; cancel canned cycles
```

G81 - Drilling and Spot Drilling

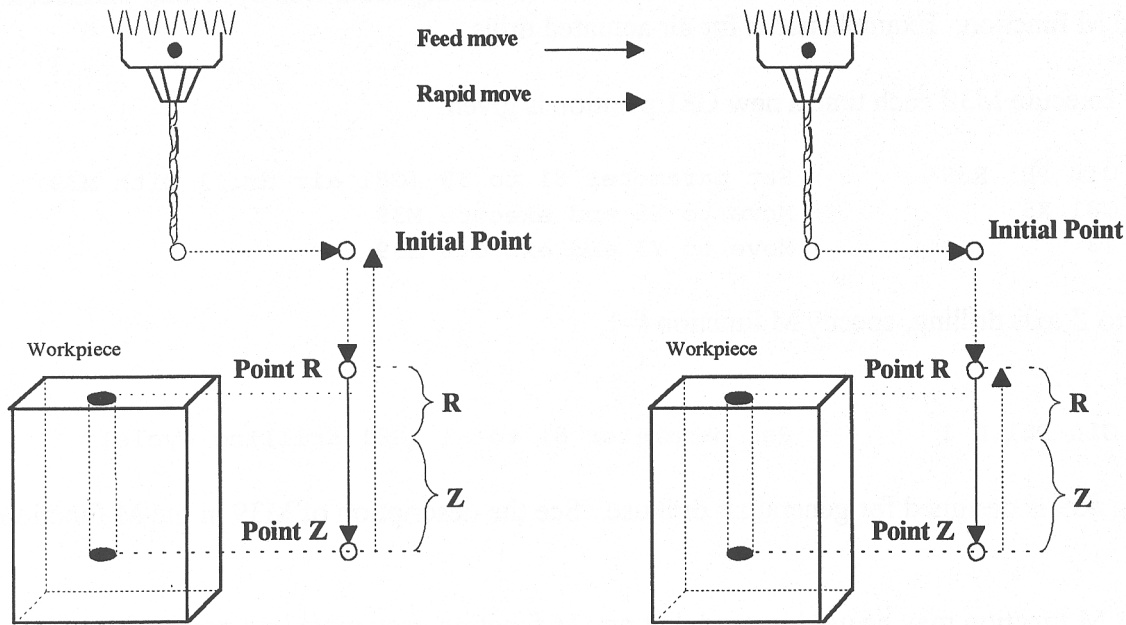

G81 using G98

G81 using G99

G81 is a general purpose drilling cycle. The hole is drilled in a single feedrate move, and then the tool is retracted at the rapid rate.

Example:

```
G90                       ; Absolute positioning
G01 X3.00 Y1.50 Z.5       ; G01 mode before canned cycle
G99                       ; Set for R point return
G81 X3.250 Y1.75 Z-.650 R.1 F3 ; Drill at X3.25 Y1.75
X4.5 Y3.5                 ; Drill at X4.5 Y3.5
G80                       ; Cancel canned cycle, return to G1
```

G81 - Drill Cycle Transformation to G81 Air Drill Cycle

G81 may be modified to execute an M function instead of moving the Z-axis by setting parameter #81 to the desired M function. Example use is for air-actuated drills.

Example: Execute M39 each time a new G81 position is given:

```
G10 P81 R39          ; Set parameter 81 to 39 (G81 air drill with M39)
G81 X5               ; Move to X5 and execute M39
Y3                   ; Move to Y3 and execute M39
```

To revert to Z-axis drilling, specify M function #-1.

Example:

```
G10 P81 R-1         ; Set parameter 81 to -1 (G81 drilling cycle)
```

M function #39 is designed for general air drill use. See the description of M39 in the M functions section.

A different M function may be used instead, but any M function used must be a macro file that uses the M103 and M104 commands to time the cycle (see the example in the M function section under M103). If the macro file does not use M103, the control will automatically cancel the job 1/2 second after starting G81. For information on creating customized M functions, review Macro M functions in Chapter 13.

The M39 default air drill cycle has a time out of 2.0 seconds. As a result, if the cycle does not complete within 2 seconds then the cycle aborts and the output relay is turned off under PLC program control.

* NOTE: The PLC program must be involved in the execution of the cycle. The PLC program is responsible for turning on relays based on M function requests and the status of program execution. The PLC program must also stop all programmed machine functions when the program is canceled. See the M39 description (Chapter 13) for a sample of an air drill cycle M function.

G82 - Drill with dwell

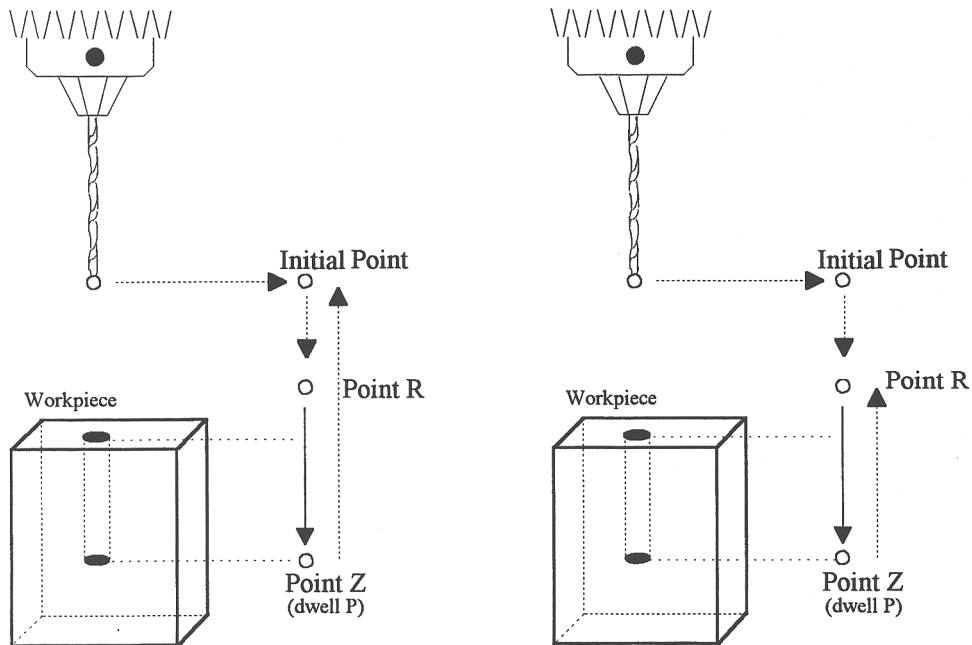

G82 Using G98

G82 Using G99

G82 is a general purpose drilling cycle similar to G81. However, G82 includes an optional dwell at the bottom of the hole before retracting the tool. This can make the depth of blind holes more accurate.

Example:

```
G82 X1 Y1 R.1 Z-.5 P.5 ; drill to Z-.5, dwell .5 seconds
```

G83 - Deep hole drilling

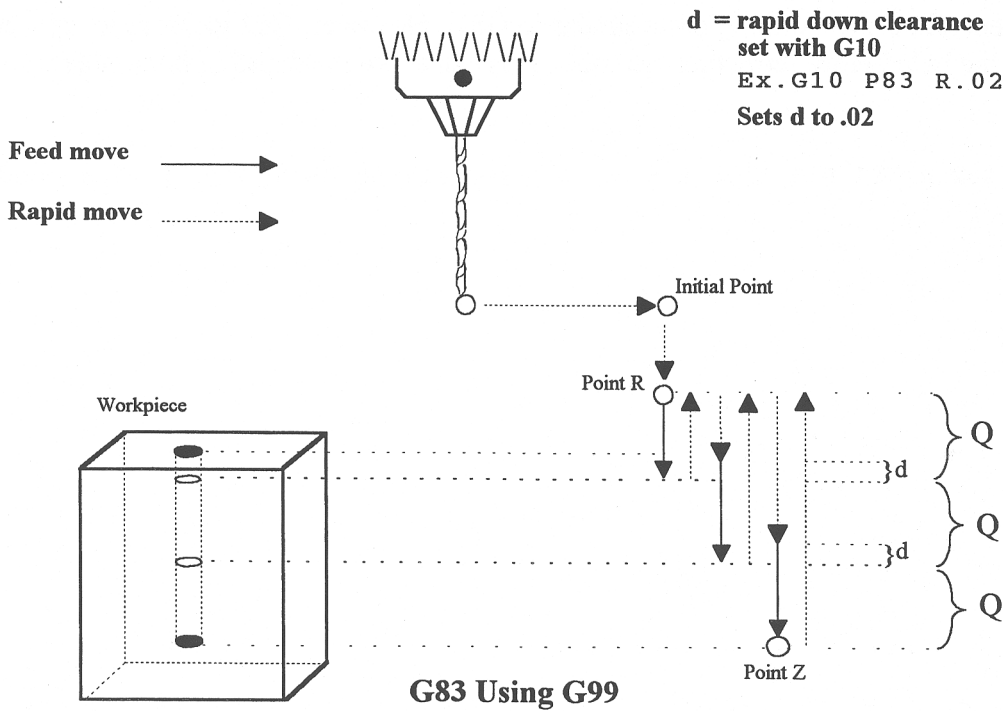
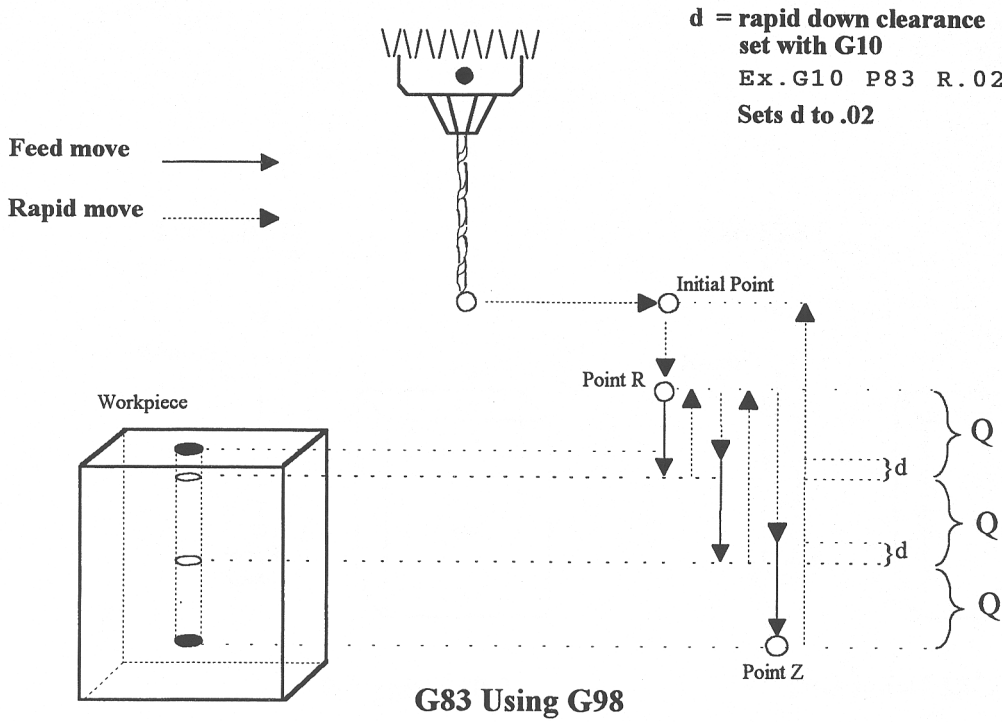

G83 is a deep hole drilling cycle. It periodically retracts the tool to the surface to clear accumulated chips, then returns to resume drilling where it left off. The retract and return are performed at the rapid rate. Because there may be chips in the bottom of the hole, the tool does not return all the way to the bottom at the rapid rate. Instead it slows to feedrate a short distance above the bottom. This clearance distance is selected by setting Parameter 83 with G10 (see example below).

Example:

```
G10 P83 R.05 ; set clearance to .05"
G83 X0 Y0 R.1 Z-2 Q.5 ; drill 2" deep hole in 0.5" steps
G80 ; cancel canned cycle
```

G84 - Tapping

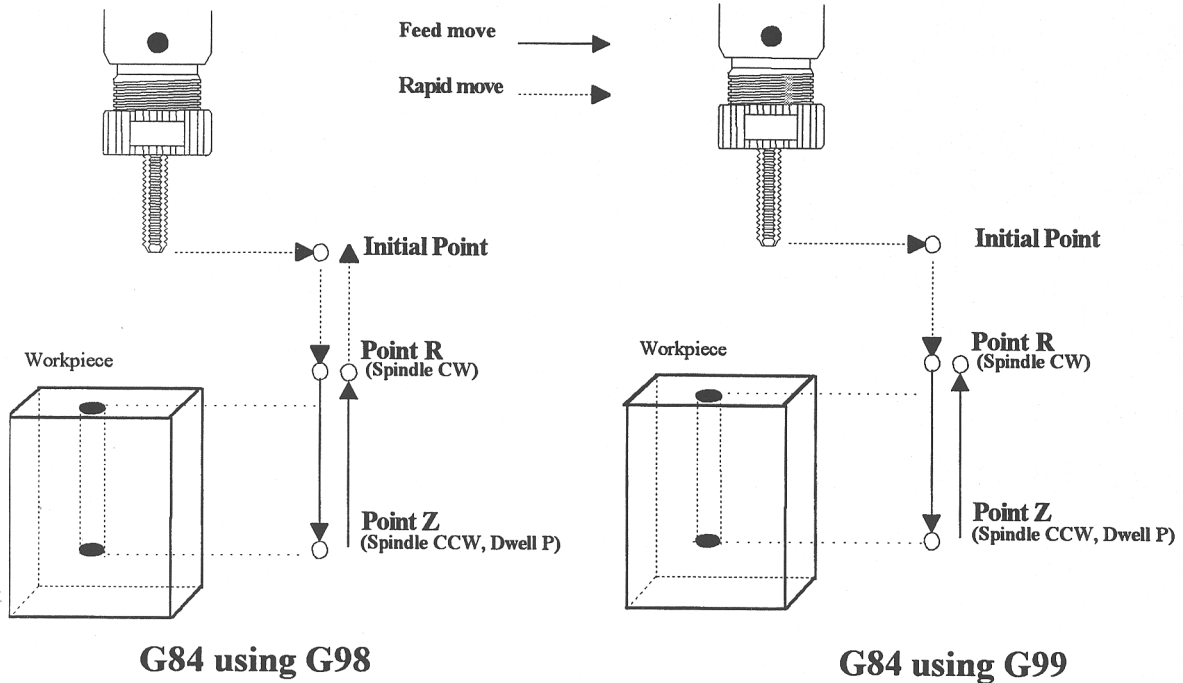

G84 performs right-hand tapping. The spindle speed (and feedrate, if you are doing floating tapping) should be set and the spindle started in the CW direction before issuing G84. G84 will normally use the default M4 to select spindle CCW (at the bottom of the hole) and M3 to re-select spindle CW (after backing out of the hole) depending on the settings of parameters 74 and 84.

The tap may continue to cut a short distance beyond the programmed Z height as the spindle comes to a stop before reversing. When tapping blind holes, be sure to specify a Z height slightly above the bottom of the hole to prevent the tool from reaching bottom before the spindle stops.

Note: If rigid tapping is enabled, a Q may be used to set the thread lead or pitch. However, because Q is not modal in the case of Rigid Tapping, you must specify Q on every line at which Rigid Tapping is to occur.

Note: At the bottom of the hole, G84 will call the default version of the specified M function even if it has been customized by an M function macro.



WARNING FEED HOLD is temporarily disabled during the tapping cycle, but it will be re-enabled at the end of the cycle.

NOTICE Pressing CYCLE CANCEL while the tap is in the hole will very probably break the tap or strip the threads in the tap hole. However, do so if it is an emergency.

Example:

```
M3 S500 F27.78 ; start spindle CW, set up for 18 pitch tap
G84 X1 Y1 R.1 Z-.5 ; tap a 0.5 deep hole at X1 Y1
Y1.5 ; ... and another one at X1 Y1.5
G80 ; cancel canned cycle
...
; Using Tool 15 Rigid Tap 6-32
G84 X0.337 Y0.925 Q0.03125 Z-0.35 R0.1 ; tap first hole
G84 X3.312 Y0.925 Q0.03125 Z-0.35 R0.1 ; tap second hole, must use Q
G80 ; cancel canned cycle
...
; Using Tool 22 Rigid Tap 4-40
G84 X1.862 Y1.627 Q0.025 Z-0.19 R0.1 ; tap first hole
G84 X2.862 Y1.627 Q0.025 Z-0.19 R0.1 ; tap second hole, must use Q
G84 X4.262 Y1.627 Q0.025 Z-0.19 R0.1 ; tap third hole, must use Q
G80 ; cancel canned cycle
```

Tech Tip – How to Setup Rigid Tapping

Overview

This section describes the theory of rigid tapping parameters, to control accuracy of depth of cut and quality of threads, in various working materials.

Graphic representation of parameter controls

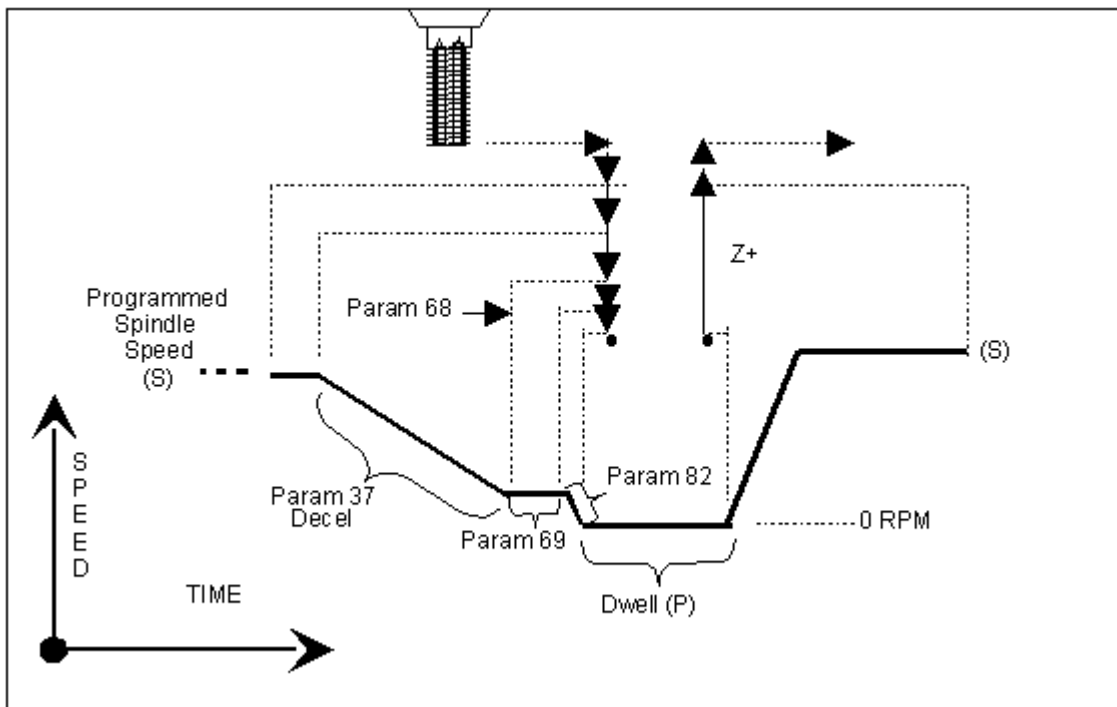

List of Rigid tapping setup parameters – see Chapter 14 for more details

Parameter	Function
34	Spindle Encoder Counts/Rev
35	Spindle Encoder Axis Number
36	Rigid Tapping Enable/Disable
37	Spindle Deceleration Time
68	Minimum Rigid Tapping Spindle Speed
69	Duration For Minimum Spindle Speed
74	M-Function executed at bottom of tapping cycle
84	M-Function executed at return to initial point of tapping cycle
82	Spindle Drift Adjustment

Graphic representation of test results for precision

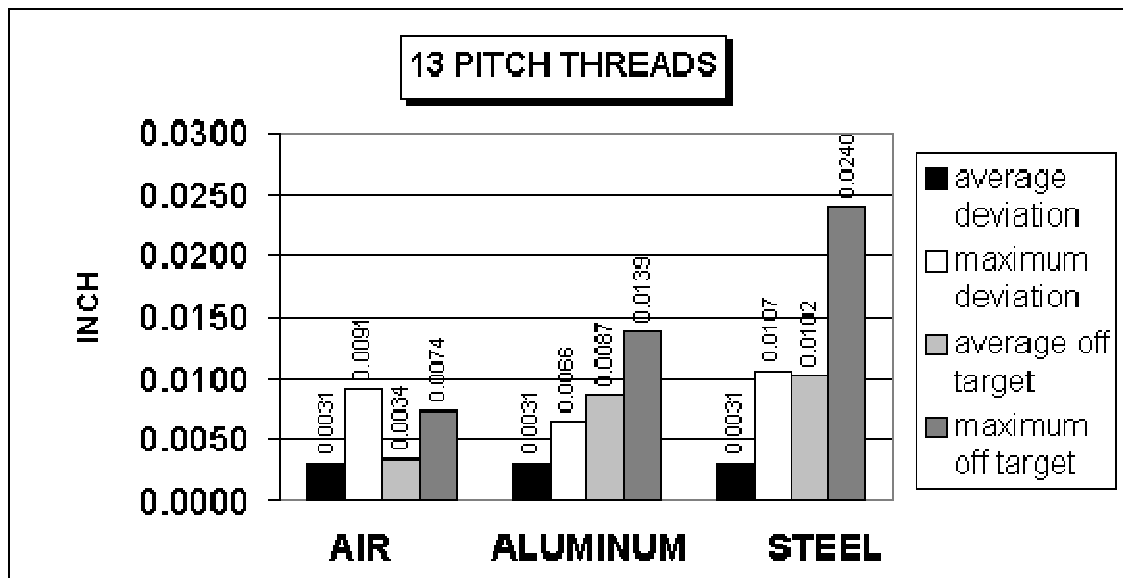

The above charts show test results of rigid tapping, utilizing version 7.14 software. The tool used in the testing was a ½-13 spiral fluted tap with TiN coating. Coolant used was water base soluble oil. Hole size was .4218. Tapping depth was .800. Also note that the parameters were adjusted to cut air, and not changed for aluminum or cold rolled steel for these tests. It can be seen, as the material changes, so does the off target values. This is due in part to the amount of torque required from the spindle to cut the various types of material. For testing purposes, the parameter settings for the above results were as follows.

Parameter 36 = 1, Parameter 37 = 3, Parameter 68 = 100, Parameter 69 = 1.25, Parameter 82 = 108

Summary

Rigid tapping parameters will vary from machine to machine. Not all machines are built the same (i.e. Spindle hp, inverter type, rigidity, etc.), and tooling will play a roll in performance also. It was found through our testing, if we changed one physical parameter, (i.e. using a tapping oil instead of water base coolant), it improved the off target values by 1.5%. This is due to the fact that less friction is present when using special cutting oil, therefore requiring less hp by the spindle to drive the tap. In most cases, rigid tapping depths should be able to be held within +/- .008 inch or less by adjusting parameter 82 for specific cases.

G85 – Boring

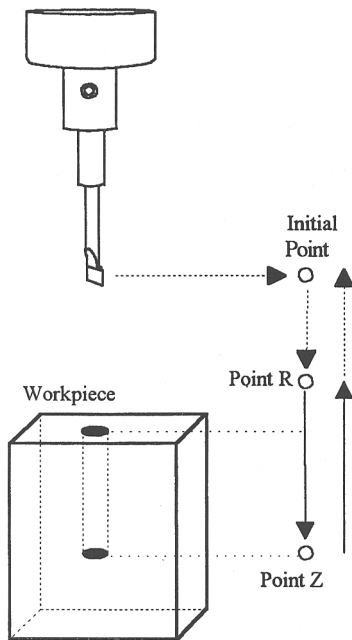

G85 Using G98

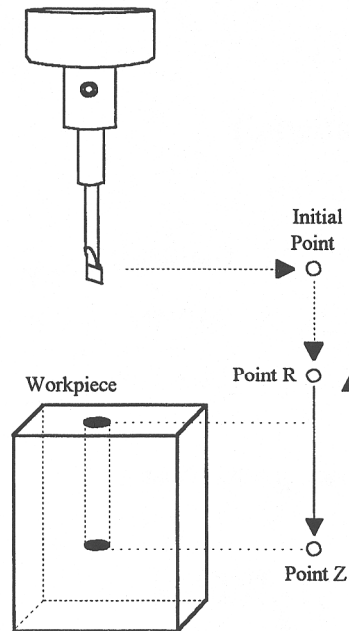

G85 Using G99

G85 is similar to G81, except that the tool is retracted with a feedrate move instead of a rapid move. G85 may be used for tapping with reversing tap heads such as the Tapmatic NCR series.

Example 1:

```
G85 X1 Y1 R.1 Z-.5 ; bore a 0.5" hole at X1 Y1  
G80 ; cancel canned cycle
```

Example 2:

```
M3 S500 F27.78 ; start spindle CW, set for 18 pitch tap  
M109/1/2 ; disable feedrate and spindle overrides  
G85 X1 Y1 R.1 Z-.4 ; tap hole at X1 Y1 to a depth of 0.4"  
M108/1/2 ; enable feedrate and spindle overrides  
G80 ; cancel canned cycle
```

G89 - Boring cycle with dwell

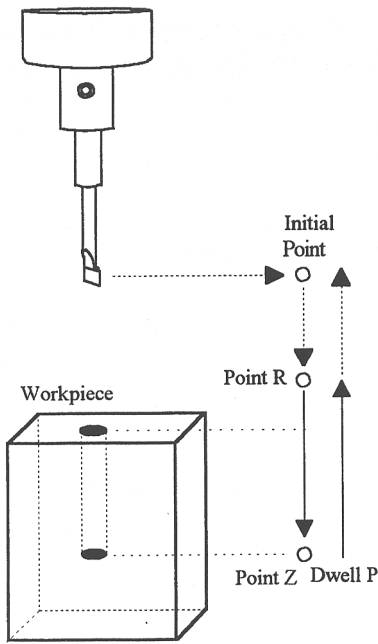

G89 Using G98

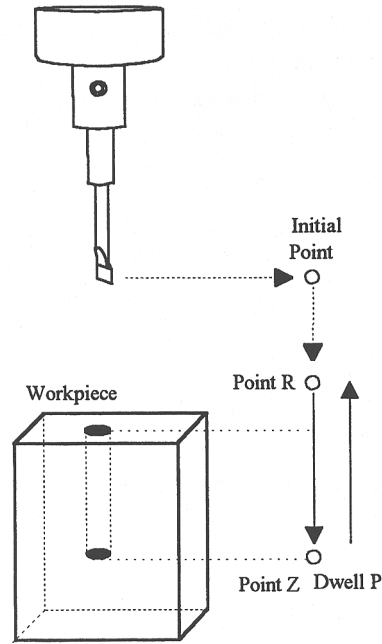

G89 Using G99

G89 is similar to G85, except that it includes an optional dwell at the bottom of the hole before retracting the tool.

Example:

```
G89 X1 Y1 R.1 Z-.5 P.1 ; bore 0.5" hole at X1 Y1, dwell .1 seconds
G80 ; cancel canned cycle
```

G90 & G91 - Absolute/Incremental Positioning Mode

G90 selects absolute positioning, and G91 selects incremental positioning. In absolute positioning, all coordinates are relative to the origin (0,0,0,0). In incremental positioning, all coordinates are distances relative to the last point.

G90 Absolute positioning

G91 Incremental coordinates

Example:

```
G90 X2 Y3 ; moves the X and Y axes from the current position
; to X2, Y3.
G91 X1 Y0 ; moves the X axis 1 inch referenced from the last X
; position, the Y axis does not move.
```

G92 - Set Absolute Position

G92 sets the current absolute position to the coordinates specified. This command only affects the currently set Work Coordinate System.

Example:

```
G0 X5 Y3 Z-2 W5 ; Moves to the specified location
G92 X1 Y0 Z0 W1 ; Sets the current position to the absolute
; position specified.
```

G93 - Inverse Time

Rather than using a conventional federate in Inch per Minute or MM per Minute, F in inverse time mode specifies the movement frequency for subsequent moves. Specifically, the inverse time feedrate is the inverse of the amount of time that a move is allowed to take.

For example, using inverse time, the block:

```
G1 G93 X10 F1
```

takes 1 minute to cut, regardless of X length. At F2.0 (1/2.0 minute) it takes 30 seconds; At F3.0 it takes 20 seconds, and so on.

G93 is Modal, and remains in effect until a G94 is issued to cancel the G93.

Example of use in a program:

```
G0 G54 G90 X2.2126 Y-1.1995 A94.75 B-.161 S3000 M3 ; Move to start
G43 H26 Z7.0002 M8
Z3.1002
G1 G93 X2.2048 Y-1.2593 Z3.0204 F100. ; Enable Inverse Time
X2.2052 Y-1.2586 Z3.0202 A94.756 B-.162 F30000. ; 1/30000 min for move
X2.2079 Y-1.2578 Z3.0197 A94.763 B-.173 F30000. ; 1/30000 min for move
X2.2124 Y-1.2566 Z3.0189 A94.773 B-.189 F30000. ; 1/30000 min for move
X2.2184 Y-1.2551 Z3.0179 A94.786 B-.212 F24065.56 ; 1/24065 min for move
X2.2258 Y-1.2533 Z3.0167 A94.802 B-.24 F19736.14 ; 1/19736 min for move
X2.2345 Y-1.2512 Z3.0155 A94.819 B-.272 F17187.45 ; 1/17187 min for move
```

G93.1 – Velocity Scrubber for Smoothed Inverse Time Data

This special feedrate interpretation mode substitutes inverse time feedrates (usually posted from a CAD/CAM program) with optimized feedrates to ensure that the tool tip center is moved at a set feedrate in physical 3D space, taking into account tool length offset and the machine geometry as set by parameters 116-119 (see Chapter 14). The set feedrate (F) can be on the same G-code line as the G93.1 or can be the last modal feedrate specified on prior G-code lines.

This mode is intended for CNC jobs run on machines configured with a triangular rotary 5th axis such as a Tilt Table or Articulated Head (see parameter 166 in Chapter 14), although that is not an enforced definite requirement to turn on this mode. It is recommended that moves programmed with this mode should be in small vectors, and any long moves that require a sweep of a rotary axis by more than 10 degrees should be broken up into 2 or more smaller moves. Note that Smoothing must also be turned on (P220 = 1) for this feature to work; otherwise, it will be treated as a regular G93 (Inverse Time).

Example of use in a program (based on the example from G93 above):

```
G0 G54 G90 X2.2126 Y-1.1995 A94.75 B-.161 S3000 M3 ; Move to start
G43 H26 Z7.0002 M8
Z3.1002
G1 G93.1 X2.2048 Y-1.2593 Z3.0204 F150. ; Force tool tip to move 150 in/min
X2.2052 Y-1.2586 Z3.0202 A94.756 B-.162 F30000. ;Ignore F..Move at 150ipm
X2.2079 Y-1.2578 Z3.0197 A94.763 B-.173 F30000. ;Ignore F..Move at 150ipm
X2.2124 Y-1.2566 Z3.0189 A94.773 B-.189 F30000. ;Ignore F..Move at 150ipm
X2.2184 Y-1.2551 Z3.0179 A94.786 B-.212 F24065.56 ;Ignore F..Move at 150ipm
X2.2258 Y-1.2533 Z3.0167 A94.802 B-.24 F19736.14 ;Ignore F..Move at 150ipm
X2.2345 Y-1.2512 Z3.0155 A94.819 B-.272 F17187.45 ;Ignore F..Move at 150ipm
```

G94 - Cancel Inverse Time

G94 is used to cancel Inverse Time feedrates, and return to regular Feed per Minute feedrates.

G98 - Initial Point Return

G98 sets the +Z return level to point I as pictured in Figure 1 in the Canned Cycle Section.
(G98 is the default setting)

G99 - R Point Return

G99 sets the +Z return level to point R as pictured in Figure 1 in the Canned Cycle Section.

G117, G118, G119 - Rotation of Pre-set Arc Planes

G117, G118 and G119 have the same functionality as G17, G18 and G19, respectively, except that they include 2 optional parameters P and Q to specify the arc plane rotation away from the pre-set arc plane: P specifies the arc plane angle of rotation (in degrees) around the first axis and Q specifies the arc plane angle of rotation around the second axis.

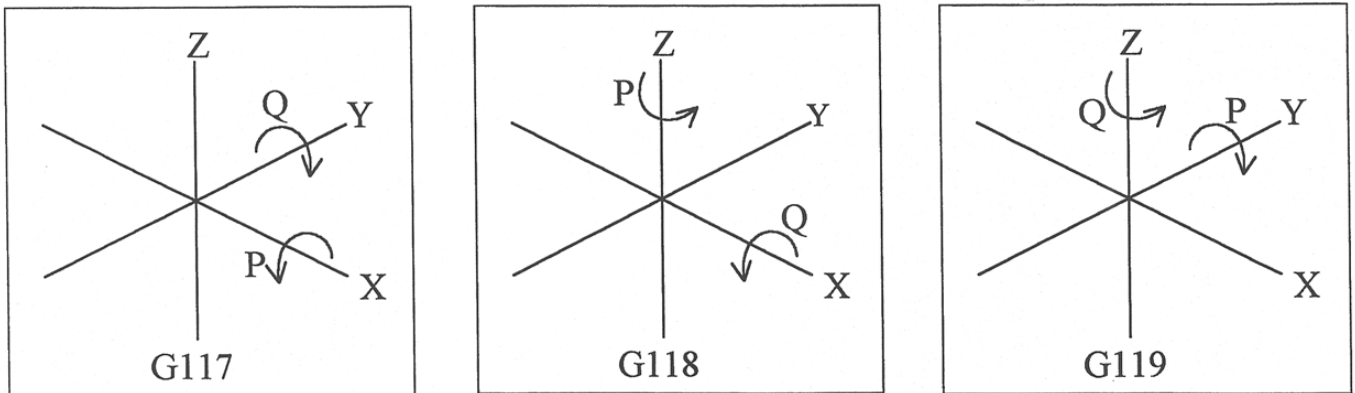

For the G117 plane, the "first axis" is X and the "second axis" is Y.

For the G118 plane, the "first axis" is Z and the "second axis" is X.

For the G119 plane, the "first axis" is Y and the "second axis" is Z. If P and/or Q are not specified, the angles are assumed to be 0 degrees. If both P and Q parameters are 0, then the plane is assumed to be an orthogonal (pre-set) arc plane. The center of the arc can be specified by the user in a 3D form both in G17-G19 and in G117-G119 (all I, J, K values are allowed at the same time with G2 and G3). Any arc center component outside the circular plane is ignored.

Example:

```
G00 X0 Y0 Z1 ; rapid move
G03 G18 X1 Y0 Z0 K-1 F20 ; arc mill
G00 X0 Y0 Z1.1 ; retract move
G01 Z1 ; move to start of contour
G03 G118 P1.000000 X0.9998 Y0.0175 Z0 K-1 ; arc mill rotated about Z
```

* NOTE: G117-G119 will not be permitted while cutter compensation is turned on. Also, scaling is not allowed while G117-G119 is specified and G117-G119 is not allowed while scaling is active.

* NOTE: G117-G119 will not work when Smoothing is turned on (P220 = 1).

G173, G174, G176, G181, G182, G183, G184, G185, G189 – Compound Canned Cycles

On a machine configured as an Articulated Head machine with the TWCS feature enabled, the Compound Canned Cycle G-codes are used to perform tilted-head Drill/Bore/Tap operations when the currently selected WCS is not transformed (TWCS=No). See Parameter 166 in Chapter 14 for information on Articulated Head configuration and turning on the TWCS feature for the machine.

On a such a machine, Compound Canned Cycles are used as an alternative to the their corresponding non-compound Canned Cycles because the non-compound versions cannot be used when the currently selected WCS is not transformed (TWCS=No) and the spindle head is tilted off vertical (B/5th axis angle is not 0). In all other situations, Compound Canned Cycles are the same in functionality as their corresponding non-compound counterparts.

Compound Canned Cycle G-code	Function	Corresponding non-compound Canned Cycle G-code
G173	Compound High Speed Peck Drilling	G73
G174	Compound Counter Tapping	G74
G176	Compound Fine Bore Cycle	G76
G181	Compound Drilling and Spot Drilling	G81
G182	Compound Drill with Dwell	G82
G183	Compound Deep Hole Drilling	G83
G184	Compound Tapping	G84
G185	Compound Boring	G85
G189	Compound Boring with Dwell	G89

G180 – Cancel Canned Cycles

G180 has the exact same functionality as G80.

Chapter 13

CNC Program Codes: M functions

M functions are used to perform specialized actions in CNC programs. Most of the M-series Control M functions have default actions, but can be customized with the use of macro files.

Summary of M functions

M00 Stop for Operator	M80 (macro) Carousel In *
M01 Optional Stop for Operator	M81 (macro) Carousel Out *
M02 Restart Program	M91 Move to Minus Home
M03 Spindle On Clockwise	M92 Move to Plus Home
M04 Spindle On Counterclockwise	M93 Release/Restore Motor Power
M05 Spindle Stop	M94,M95 Output On/Off
M06 Tool Change	M98 Call Subprogram
M07 Mist Coolant On	M99 Return from Macro or Subprogram
M08 Flood Coolant On	M100 Wait for PLC bit (Open, Off, Reset)
M09 Coolant Off	M101 Wait for PLC bit (Closed, On, Set)
M10 Clamp On	M102 Restart Program
M11 Clamp Off	M103 Programmed Action Timer
M14 (macro) Swing Arm Pot Up *	M104 Cancel Programmed Action Timer
M15 (macro) Unclamp Tool with air on *	M105 Move Minus to Switch
M16 (macro) Unclamp Tool with air off *	M106 Move Plus to Switch
M17 (macro) Prepare for Tool Change *	M107 Output Tool Number
M18 (macro) Home Tool Changer *	M108 Enable Override Controls
M19 (macro) Orient Spindle *	M109 Disable Override Controls
M20 (macro) Pickup Tool *	M115,M116,M125,M126 Protected Move Probing Functions
M21 (macro) Move Head Up *	M120 Open data file (overwrite existing file)
M22 (macro) Move Head to ATC level *	M121 Open data file (append to existing file)
M23 (macro) Rotate Carousel *	M122 Record local position(s) in data file
M24 (macro) Start Tool Put-back *	M123 Record value and/or comment in data file
M25 Move to Z Home	M124 Record machine position(s) in data file
M26 Set Axis Home	M127 Record Date and Time in a data file
M30 Customizable M-code for End of Intercon Program	M128 Move Axis by Encoder Counts
M39 Air Drill	M129 Record Current Job file path to data file
M41 (macro) Select Low Spindle Gear Range *	M130 Run system command
M42 (macro) Select Medium-Low Spindle Gear Range *	M200/M201 Stop for Operator, Prompt for Action
M43 (macro) Select High Spindle Gear Range *	M223 Write Formatted String to File
M50 (macro) Index Tool Plus *	M224 Prompt for Operator Input Using Formatted String
M51 (macro) Index Tool Minus *	M225 Display Formatted String for A Period of Time
M60 (macro) 5 Axis Digitizing *	M300 Fast Synchronous I/O update
	M1000-M1015 Graphing Color for Feedrate movement

* M functions marked with “(macro)” actually have no standard default action, and could possibly be unimplemented and therefore unavailable on your machine. Also, their stated function is only standard on certain machines.

Macro M functions (custom M functions)

Most M-Series CNC M functions from 0 through 90 can be fully customized. Exceptions are M2, M6, and M25 that can be customized, but will always move the 3rd (Z) axis to the home position before executing the macro M function commands. No M functions above 90 may be customized with macros. The default action listed will be performed unless that M function has been customized.

To create a macro for an M-function, a file must be created in the C:\cncm directory. The file's name must be mfuncXX.mac where XX is the M function number used to call the macro. M functions 0-9 must use single digits in the filename (e.g. Use mfunc3.mac, **not** mfunc03.mac). The contents of the file may be any valid M and G codes.

Each time the M function is encountered in a program, the macro file will be processed line by line.

* NOTE: Nesting of macro M functions is allowed. Recursive calls are not: if a macro M function calls itself, the default action of the function will be executed.

Example: Turn on spindle with variable frequency drive and wait for "at speed" response. This example depends on M94/M95 1 being used for the Spindle Enable signal and input 5 being the spindle at speed signal in the PLC program.

Create file c:\cncm\mfunc3.mac with contents as follows:

```
M94/1      ; request spindle start
M101/50005 ; wait for up to speed signal
```

M2, M6, and M25 **always** move the Z-axis to the home position before any other motion. All other M functions are performed after the motion of the current line is complete.

The M and G codes in a macro M function are not usually displayed on the screen as they are executed, and are all treated as one operation in block mode. If you wish to see or step through macro M functions (e.g. for testing purposes), set parameter #10 as follows:

- 0 Don't display or step through macro M functions
- 1 Display macro M functions, but don't step through them
- 2 Display and step through macro M functions

* NOTE: You cannot use block mode to step through a macro M function called using the G81 transformation (see Chapter 12); the action timer will expire before you can press **CYCLE START**.

NOTE: Only one M function per line is permitted.

* NOTE: Unlike subprograms invoked with G65, macro arguments passed into a macro M function are passed in by reference. This means local changes to #1 through #33 or #A through #Z will change their values upon return from the macro M function.

M00 - Stop for Operator

Motion stops, and the operator is prompted to press the **CYCLE START** button to continue.

M01 - Optional Stop for Operator

M1 is an optional pause, whose action can be selected by the operator.

When optional stops are turned on, M1 will pause the currently running job until **CYCLE START** is pressed. However, if optional stops are turned off, M1 will not pause the program.

*NOTE: If you plan to override the default action of M1 with a macro file, you may want to include a call to M1 within the macro file so that the default actions of M1 will still be effective in the overridden M1. Otherwise, if a call to M1 is not included within the macro file, the new overridden M1 will cause optional stops to be ineffective.

M02 - Restart Program

M2 moves the Z-axis to the home position, performs any movement requested, and restarts the program from the first line. The operator is prompted to press the **CYCLE START** button to continue.

M03 - Spindle On Clockwise

M3 requests the PLC to start the spindle in the clockwise direction.

Default action:

M95/2
M94/1

M04 - Spindle On Counterclockwise

M4 requests the PLC to start the spindle in the counterclockwise direction.

Default action:

M95/1
M94/2

M05 - Spindle Stop

M5 requests the PLC to stop the spindle.

Default action if the spindle had been spinning CW:

M95/2
M95/1

Default action if the spindle was OFF or was spinning CCW:

M95/1
M95/2

M06 - Tool Change

M6 moves the Z-axis to the home position and stops the spindle and coolant. If an automatic tool changer is installed, it then commands the tool changer to switch to the requested tool. Otherwise, it prompts the operator to insert the tool and then press the **CYCLE START** button on the Operator Panel.

Default action (no tool changer):

M25 ; always does M25 first
M95/1/2/3/5 ; turn off spindle & coolant
M100/75 ; wait for **CYCLE START** button

Default action (tool changer installed):

M25	; always does M25 first
M95/1/2/3/5	; turn off spindle & coolant
M95/16	; turn off tool changer strobe
M107	; send tool number to tool changer
M94/16	; turn on tool changer strobe
M101/32	; wait for acknowledge from changer
M95/16	; turn off tool changer strobe
M100/32	; wait for acknowledge from changer

Manual tool changes are selected by setting Parameter 6 to 0 in the Machine Parameters table. The automatic tool changer is selected by setting Parameter 6 to 1 (see Chapter 14).

The PLC program must be involved in commanding an automatic tool changer and its associated strobe, BCD and Acknowledge lines. See Chapter 5 of the service manual for details of how such a PLC program could be constructed.

M07 - Mist Coolant On

M7 causes the PLC to start the mist coolant system.

Default action:

M95/3
M94/5

M08 - Flood Coolant On

M8 causes the PLC to start the flood coolant system.

Default action:

M95/5
M94/3

M09 - Coolant Off

M9 causes the PLC to stop the coolant system.

Default action:

M95/3/5

M10 - Clamp On

M10 causes the PLC to activate the clamp.

Default action:

M94/4

Note: adding 256 to parameter 178 can switch M10 and M11.

M11 - Clamp Off

M11 causes the PLC to release the clamp.

Default action:

M95/4

M17 – Prepare for Tool Change (Macro)

M17 has no default action, therefore a custom M17 macro must be defined for this feature to work. If defined, the M17 macro turns off spindle and coolant and starts the spindle orientation process in preparation for M6 (Tool Change). The M17 macro is allocated for use with Intercon and the setting in Parameter 162. See Parameter 162 in Chapter 14 for more information.

M19 – Spindle Orient (Macro)

M19 has no default action, therefore a custom M19 macro must be defined for this feature to work. If defined, the M19 macro sends a request to the PLC to rotate the spindle to its pre-set orient position.

M25 - Move to Z Home

M25 moves the Z-axis to the home position at the Z-axis maximum rate. The Z home position defaults to zero in machine coordinates, but may be changed by changing the Z coordinate of the first Reference Point (on the Work Coordinate System Configuration screen).

Default action:

```
G0 <Z home >
```

M26 - Set Axis Home

M26 sets the machine home position for the specified axis to the current position (after the line's movement). If no axis is specified, M26 sets the Z-axis home position.

Example:

```
M91/X      ; home X axis to minus home switch
M26/X      ; set machine home for X-axis there
M92/Z      ; home Z-axis to plus home switch
M26        ; set machine home for Z-axis there
```

M30 - Custom M Code

Intercon posts an M30 at the end of every G code program. By default M30 performs no operation. If you wish to perform certain operations at the end of every program, this M code can be customized to meet your needs. For more information on customizing M codes see the beginning of this chapter.

M39 - Air Drill

M39 is a default air drill activation sequence with a timeout. The sequence of operations is as follows:

```
M94/15      ; activate M function request 15
M103/2      ; start 2 second timer
M100/50015  ; wait for input 15 to open
M95/15      ; deactivate M function request 15
M104        ; cancel timer
```

* NOTE: This program will be canceled by timer expiration if input 15 does not open within 2 seconds after M function request 15 is activated. The PLC program must be involved in taking away the drill output when the CNC program stops:

Example:

```

; PLC program fragment
CNC_program_running is SV_PROGRAM_RUNNING ;program running indicator
M15 is SV_M94_M95_15 ; M function 15 indicator
drill_out is OUT5 ; air drill output relay
if M15 && CNC_program_running then (drill_out) ; Drill On if M94/15 and the
; CNC program is running. Drill
; Off if M95/15 or the CNC
; program is terminated.

```

M41, M42, M43 – Select Spindle Gear Range (Macros)

M41, M42, and M43 have no default actions, and therefore custom macros must be defined for these M codes in order to make this feature work. If defined, these macros notify the PLC of which spindle gear range is selected according to the following table:

Macro M function	Action
M41	Select Low Gear Range
M42	Select Medium-Low Gear Range
M43	Select High Gear Range

Note that selecting a “Medium-High” Gear Range is currently not supported by this schema, although that would not prevent a system intergrator from defining another custom macro M function to do that.

M60 – 5-Axis Digitizing Macro

The M60 is used only when digitizing with the 5-Axis Tilt Table system.

The M60 uses user variables to assign a “Start Position” and a “Finish Position” for 5-Axis Digitizing. When the M60 is executed, the probe will be moved from the start position to the end position. If during the motion the probe detects a surface, the surface position is recorded, and the probe returns to the start position. If no surface is found the probe returns to the start position.

The following variables are to be assigned before the M60 is called, the M60 will then use the positions as assigned by the user variables:

- #29100 = X-Axis Probing vector start point (Initial Position)
- #29101 = Y-Axis Probing vector start point (Initial Position)
- #29102 = Z-Axis Probing vector start point (Initial Position)
- #29103 = A-Axis Probing vector start point (Initial Position)
- #29104 = B-Axis Probing vector start point (Initial Position)
- #29110 = X-Axis Probing vector end point
- #29111 = Y-Axis Probing vector end point
- #29112 = Z-Axis Probing vector end point

Upon a successful probe the M60 will use an M122 to save the probed position to a text file that should be opened using an M120 or M121 before calling the M60

Example M60 use in a program:

```
M121 "m60test.dig5"      ; Open text file to record data too

#29100 = -8.7999 ; X-Axis Start Position

#29101 = .3747      ; Y-Axis Start Position

#29102 = -1.1832 ; Z-Axis Start Position

#29103 = 85.957    ; A-Axis Start Position

#29104 = 21.36     ; B-Axis Start Position

#29110 = -8.7138 ; X-Axis End Position

#29111 = -.0159   ; Y-Axis End Position

#29112 = -1.183   ; Z-Axis End Position

M60                ; Execute M60
```

M91 - Move to Minus Home

M91 moves to the minus home switch of the axis specified at the slow jog rate for that axis. After the minus home switch is tripped, the axis reverses until the home switch clears, and stops when it detects the index pulse.

Example:

```
M91/X      ; moves the X-axis to the minus home switch.
G92 X-10   ; sets X minus home switch at -10
```

M92 - Move to Plus Home

M92 moves to the plus home switch of the axis specified at the slow jog rate for that axis. After the plus home switch is tripped, the axis reverses until the home switch clears, and stops when it detects the index pulse.

Example:

```
M92/X      ; moves the X-axis to the plus home switch.
G92 X+10   ; Sets X plus home switch at +10
```

M93 – Release/Restore Motor Power

M93 releases or restores motor power for the axis specified. If no axis is specified, then all axes are released.

Example:

To release motor power:

```
M93/X      ; releases the X axis.
M93        ; releases the motors on all axes.
```

Example:

To restore power:

```
M93/X P1   ; restore power to the X axis motor.
M93 P1     ; restore power to the motors on all axes.
```

M94/M95 - Output On/Off

There are 128 user definable system variable bits that can be used to communicate with the PLC. M94 and M95 are used to request those system variable bits to turn on or off respectively. Requests 1-128 are mapped to the PLC as system variables SV_M94_M95_1 through SV_M94_M95_128 as shown in the following table:

On	Off	PLC bit
M94/1	M95/1	SV_M94_M95_1
M94/2	M95/2	SV_M94_M95_2
M94/3	M95/3	SV_M94_M95_3
M94/4	M95/4	SV_M94_M95_4
.	.	.
.	.	.
.	.	.
M94/128	M95/128	SV_M94_M95_128

To use M94 and M95 to control a function external to the servo control, such as an indexer, the input request must be mapped to one of the PLC outputs in the PLC program. See M94/M95 function usage in the PLC section of the service manual.

Example:

M94/5/6 ; turns on SV_M94_M95_5 and SV_M94_M95_6.

* NOTE: M94 and M95 will cause prior motion to decelerate to a stop before the requested bits are turned on or off.

* NOTE: Requests 1-5, 15, and 16 are controlled by the default actions of M3, M4, M5, M6, M7, M8, M9, M10, M11, and M39. To override or disable a bit used in one of these M codes, define a custom M-function.

M98 - Call Subprogram

M98 calls a user-specified subprogram. A subprogram is a separate program that can be used to perform a certain operation (e.g. a drilling pattern, contour, etc.) many times throughout a main program.

Calling methods:

M98 Pxxxx Lrrrr

Or

M98 "program.cnc" Lrrrr

where *xxxx* is the subprogram number (referring to file Oxxxx.cnc, 9100-9999 allowed, leading 0's required in filename, capital O, lowercase .cnc), *rrrr* is the repeat value, and "program.cnc" is the name of the subprogram file.

Subprograms are written just like normal programs, with one exception: an M99 should be at the end of the subprogram. M99 transfers control back to the calling program.

Subprograms can call other subprograms (up to 20 nested levels of calling may be used), Macro M-functions, and Macros. Macro M-functions and Macros can similarly call subprograms.

Subprograms 9100-9999 can also be embedded into a main program, using O9xxx to designate the beginning of the subprogram and M99 to end it. The CNC software will read the subprogram and generate a file O9xxx.cnc. The CNC will not execute the subprogram until it encounters M98 P9xxx.

NOTE: An embedded subprogram definition must be placed before any calls to the subprogram.

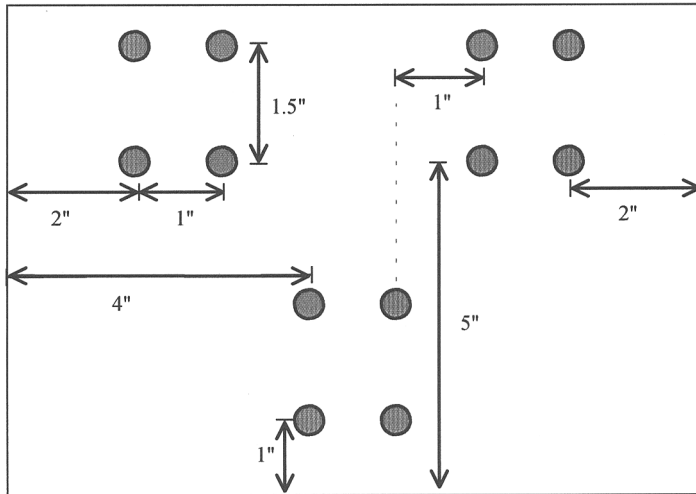

(0,0)

Suppose that a drilling pattern of 4 holes is needed in 3 different locations.

This subprogram would handle the drilling and incremental moves between the holes:

```
O9101                ;Program O9101.cnc
G91 F10             ;Incremental positioning
G81 X0 Y0 R -.4 Z-.6 ;Drill lower left hole
Y1.5 R -.4 Z-.6    ;Drill upper left hole
X1 R -.4 Z-.6      ;Drill upper right hole
Y-1.5 R-.4 Z-.6   ;Drill lower right hole
G80                 ;Cancel canned cycles
M99                 ;End of subprogram
```

The main program would call this subprogram three times:

```
:Main program
G90 G0 X2 Y5 Z0.5   ;Move to first hole pattern
M98 P9101 L1        ;Call subprogram O9101.cnc
G90 G0 X4 Y1 Z0.5   ;Move to second hole pattern
M98 P9101 L1        ;Call subprogram
G90 G0 X6 Y5 Z0.5   ;Move to third hole pattern
M98 P9101 L1        ;Call subprogram
:End program
```

Another example is "looping" or consecutively repeating a section of code. Here, the subprogram will be part of the main program.

```
:Main program
G90 G0 X0 Y0 Z0.1
G1 Z0 F30
O9100                ;Beginning of subprogram
G91 G1 Z-0.1 F5
G90 X2 F30
Y2
X0 Y0
M99                 ;End of subprogram 9100
M98 P9100 L3        ;Repeat O9100 3 times
M25 G49             ;End main program
```

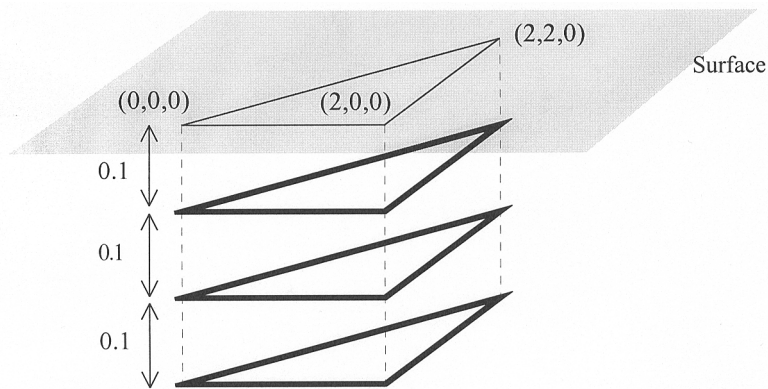
M99 - Return from Macro or Subprogram

M99 designates the end of a subprogram or macro and transfers control back to the calling program when executed. M99 may be specified on a line with other G codes. M99 will be the last action executed on a line. If M99 is not specified in a subprogram file, M99 is assumed at the end of the file:

Example:

G1 X3 M99 ;Move to X3 then return to calling program.

If M99 is encountered in the main job file, it will be interpreted as the end of the job. If M99 is encountered in an M function macro file, it will be interpreted as the end of any enclosing subprogram or macro, or as the end of the job.

M100 - Wait for PLC bit (Open, Off, Reset)

M101 - Wait for PLC bit (Closed, On, Set)

The M100/M101 commands wait for a PLC bit to reach a state as indicated in the table below.

Number	PLC bit	M100	M101
50001 – 51312	INP1 – INP1312	open	closed
60001 – 61312	OUT1 – OUT1312	off	on
70001 – 71024	MEM1 – MEM1024	reset	set
90001 – 90064	T1 – T64 status bits	reset (not expired)	set (expired)
93001 – 93256	STG1 – STG256 status bits	reset (disabled)	set (enabled)
94001 – 94256	FSTG – FTSG256 status bits	reset (disabled)	set (enabled)
The number ranges 1-240 can be used to reference the first eighty INP, OUT, or MEM bits. It is recommended that existing CNC10 programs and macros be converted to the new ranges for use with CNC11.			
1 – 80	INP1 – INP80	open	closed
81 – 160	OUT1 – OUT80	off	on
161 – 240	MEM1 – MEM80	reset	set

Example:

M101/50001 ; wait for INP1 to close
M100/60002 ; wait for OUT2 to turn off
M101/70123 ; wait for MEM123 to be set (1)

NOTE: The numbers assigned to the PLC bits (except 1-240) are the same as those that can be used when referencing system variables in M- and G-code programs.

M102 - Restart Program

M102 performs any movement requested, and restarts the program from the first line. The Z-axis is **NOT** moved to the home position, and the operator is **NOT** prompted to press the **CYCLE START** button to continue.

M103 - Programmed Action Timer

M103 is used to set up the time limit for a timed operation. If the timer is canceled (usually by M104) before the specified time limit, the program will be canceled and the message "Programmed action timer expired" will be displayed. If another M103 is issued before the time limit expires, then this time limit is nullified and the new time limit will be set up as specified by the latest occurring M103. Note also that if M0 or M1 causes the program to stop momentarily and the "M0 jogging" feature is enabled, then the timer will also be canceled without the need to issue M104.

Example: Activate a device and wait for a response. If there is no response within 4.5 seconds, cancel the program.

```
M94/12           ; turn on input request 12
M103/4.5         ; start 4.5 second timer
M100/4           ; wait for input 4 to open
M104             ; input 4 opened, cancel timer
```

M104 - Cancel Programmed Action Timer

M104 stops the timer started by the last M103 executed.

M105 - Move Minus to Switch

M105 moves the requested axis in the minus direction at the current feedrate until the specified switch opens (if the given P parameter is positive), or until the specified switch closes (if P parameter is negative).

Example:

```
M105/X P5 F30    ; move the X axis in minus direction at 30"/min until
                  ; the switch on INP5 opens
G92 X10          ; Sets X position to 10
M105/Z P-6       ; move the Z axis in minus direction until switch on INP6 closes
```

M106 - Move Plus to Switch

M106 moves the requested axis in the plus direction at the current feedrate until the specified switch opens (if the given P parameter is positive), or until the specified switch closes (if P parameter is negative).

Example:

```
M106/Z P3 F30    ; move the Z axis in the plus direction at 30"/min, until
                  ; the switch on INP3 opens
G92 X10          ; Sets Z position to 10
M106/X P-3       ; move the X axis in the plus direction until the switch on INP3 closes
```

M107 - Output Tool Number

M107 sends the current tool number to the automatic tool changer, via the PLC. M107 does not set the tool changer strobe or look for an acknowledgement from the changer (see M6).

Example:

```
M107             ; send request for tool to change
M94/16           ; turn on tool changer strobe
M101/5           ; wait for acknowledge on input 5
M95/16           ; turn off strobe
M100/5           ; wait for acknowledge to be removed
```

M108 - Enable Override Controls

M108 re-enables the feedrate override and/or spindle speed override controls if they were disabled with M109. A parameter of “1” indicates the feedrate override; “2” indicates the spindle speed override.

Example:

```
M109/1/2           ; disables feedrate and spindle speed overrides
M108/1             ; re-enables feedrate override
M108/2             ; re-enables spindle speed override
```

M109 - Disable Override Controls

M109 disables the feedrate override and/or spindle speed override controls. It may be used before tapping with G85 to assure that the machine runs at the programmed feedrate and spindle speed. It is not necessary to specify M109 with G74 or G84; those cycles automatically disable and re-enable the override controls. M109 cannot be used in MDI mode.

Example:

```
M3 S500           ; start spindle in clockwise direction, at 500 rpm
F27.78            ; set feedrate for 18 pitch tap
M109/1/2         ; disable feedrate and spindle speed overrides
G85 X0 Y0 R.1 Z-.5 ; tap a hole
M108/1/2         ; re-enable overrides
```

M115/M116/M125/M126* – Protected Move Probing Functions

The protected move probing functions provide the capability to program customized probing routines.

The structure for these commands is: **Mnnn /Axis pos Pp Ff LI**

Where:

<i>nnn</i>	is either 115, 116, 125, or 126.
<i>Axis</i>	is a valid axis label, i.e., X, Y, Z, etc.
<i>pos</i>	is an optional position
<i>P</i>	is a PLC bit number, which can be negative.
<i>F*</i>	is a feedrate (in units per minute.)
<i>LI*</i>	options for the M115/M116 commands that prevents an error if the probe does not detect a surface
<i>Q1</i>	is an option for M115/M116 that forces the DSP probe to move a “Recovery Distance” on retries. (See Machine Parameter 13 for “Recovery Distance”)

Note: the Q1 option only applies for DSP Probes

For M115 and M116 functions, the indicated *axis* will move to *pos* (if specified) until the corresponding PLC bit *p* state is 1, unless *p* is negative, in which case movement is until the PLC bit state is 0(closed). A “*p* value” of 1 to 80 (or -1 to -80) specifies PLC bits INP1-INP80. Warnings are generated in the CNC software message window for “Missing *P* value” and “Invalid *P* value.” If “*pos*” is not specified, M115 will move the *axis* in the negative direction, and M116 will move the *axis* in the positive direction. Note if “*pos*” is specified, then it does not matter whether M115 or M116 is used. Regardless of whether or not *pos* is specified, movement is bound by the settings in the software travel limits as well the maximum probing distance (Machine Parameter 16).

For M125 and M126 protected move functions, the behavior is identical to that of the M115 and M116 commands, except in regards to the PLC bit state. The M115 and M116 commands are to be used when one expects contact to be made and M125 and M126 commands are to be used when one does not expect any contact to be made.

Example:

Finding the center of a vertical slot. In this example, it is assumed that there is a probe connected to INP15 and that the probe tip is positioned somewhere in the slot, such that movement along the X-axis will cause a probe trigger.

```
M115/X P-15 F20      ; Move X minus at 20 ipm until probe trip
M116/X P15 F5        ; Move X plus at 5 ipm until probe clears
#100 = #5041          ; Record the point in user variable #100
M116/X P-15 F20      ; Move X plus at 20 ipm until probe trip
M115/X P15 F5        ; Move X minus at 5 ipm until probe clears
X[[#100+#5041]/2]    ; Move X to center of slot
```

*Usage is slightly different when using a DSP type probe. Please see below for dissimilarities between a standard DP4 probe and the DSP type probe.

***M115/M116/M125/M126 - DSP Probe specific information**

Before attempting to use the protected move probing functions with a DSP type probe, please be sure to familiarize yourself with the DSP probe configuration in Chapter 9 of this manual. Using the protected probing moves with a DSP type probe may yield unexpected results if you do not fully understand the concepts and guidelines discussed in the DSP probe configuration section.

If the control is configured to use a DSP type probe, all M115/M116 moves will perform window checking and repeat on a failed window. On a failed window, a repeat attempt is made by returning to the starting point of the move.

Protected move probing functions follow the same command format as that of a standard probe (Mnnn /Axis pos Pp Ff L1) with the following exceptions:

- f* This will be ignored if “Force DSP Feedrate in M115/M116” has been set to yes.
- L1* Still prevents a fault from occurring. Stores last DSP position on failed window.
- L2* Like L1, prevents a fault from occurring but instead stores last mechanical pos. on failed window.
- Q1* On a failed window, force a pull back distance equal to the Probing Recovery Distance (Parameter 13), instead of moving back to the starting point.

DSP position vs. mechanical position:

Protected probing moves that are performed using a standard DP4 probe can collect only the point at which motion has stopped after detecting contact. This position is referred to as the “mechanical position”. When using the DSP type probe, it detects and stores the contact position “on the fly”. This position is in machine position (not a local WCS position) and is referred to as the DSP position.

Example from above – Modified to use a DSP type probe:

Finding the center of a vertical slot.

```
M115/X P-15          ; Move X minus at DSP rate until probe trip (no feedrate needed)
#100 = [[#24301]-[#2500]] ; Convert point to current WCS position, Store point in variable #100
M116/X P15           ; Move X minus at 5 ipm until probe clears
M116/X P-15          ; Move X plus at DSP rate until probe trip
X[[#100+[[#24301]-[#2500]]]/2] ; Move X to center of slot
```

Retrieving the DSP position:

The last stored DSP position for axes 1-5 can be retrieved from system variables #24301-#24305 unless the L2 switch was used in which case #24301-#24305 will contain the mechanical position after a failed window.

M120 - Open data file (overwrite existing file)

This M function will open the requested data file for writing. If no drive or directory is specified with the file name, then the file will be opened in the same directory as the CNC program. If the file cannot be successfully opened, then an error will be returned, ultimately terminating the job. If a data file is already open when M120 is called, that file will first be closed, then the new file opened.

Example:

```
M120 "probetst.dat" ; Opens probetst.dat file to write data too
```

Note: M120 and M121 also allow use of the string user variables #300 - #399 to specify a filename. As an example, given that #300 = "myfile" and #301 = "cnc"

```
M120 "#300.#301" ;Opens the file "myfile.cnc" for data recording.
```

Keep in mind however that there is a quirk in the way that the M120/M121 operates that requires the '.' to be present so assigning #301 = ".cnc" and executing M120 "#300#301" does not work and generates a "Could not open file" error message.

M121 - Open data file (append to existing file)

This M function will open the requested file for writing at the end of the file. If no drive or directory is specified with the file name, then the file will be opened in the same directory as the CNC program. If the file does not already exist, it will be created. This is not an error. If the file cannot be successfully opened, then an error will be returned, ultimately terminating the job. If a data file is already open when M121 is called, that file will first be closed, then the new file opened.

Example:

```
M121 "c:\probetst.dat" ; Opens probetst.dat file to add data to it
```

String variables #300-#399 may also be used to specify a file name. Please see M120 above for details.

M122 - Record local position(s) and optional comment in data file

This M function will write the current expected position value to the data file, in the usual format (i.e. axis label before number, 4 decimal places in inch mode, 3 decimal places in millimeter mode. Any comment that appeared on the line with M122 will be outputted after the position(s). With no axis arguments, M122 will write the positions of all installed axes. With axis arguments, it will write the positions only of the requested axes. Positions will be written in local (not machine) coordinates, in native machine units. If no data file has been opened with M120 or M121 before M122 is called, then M122 will return an error and terminate the job. The parameter L1 may be used to suppress the new line character normally outputted after the last position. Furthermore, the output of axis labels, comma separators, and spaces can be enabled or suppressed via machine parameter 72 (see Parameter 72 in Chapter 14). If the control has been configured to use a DSP probe type, using parameter Q1 will write the values stored in #24301-#24305 to the file.

Examples (M function and sample output):

```
M122 ;comment -> X1.2345 Y-3.2109 Z-0.5678 ;comment
M122 /X L1 -> X-1.5000
M122 /X -> X-1.5000 X-2.0000
```

M123 - Record value and/or comment in data file

This M function will write the specified parameter value (if any) to the data file, followed by any comment that appeared on the line with M123. If a P value is specified, M123 will record the numeric value (4 decimal places in inches, 3 in millimeters). If neither a P value nor a comment was specified, M123 does nothing. This is not an error. If no data file has been opened with M120 or M121 before M123 is called, then M123 will return an error and terminate the job. The parameter L1 may be used to suppress the new line character normally outputted after the last value. The R and Q parameters can be used to specify the field width and precision, respectively. Furthermore, the output of axis labels, comma separators, and spaces can be enabled or suppressed via machine parameter 72 (see Parameter 72 in Chapter 14).

Examples (M function and sample output):

```
M123 ;1.2345                ->1.2345
M123 P#A ; first macro argument  ->1.2345 first macro argument
M123 Q0 P1.23                ->1
```

M124 - Record machine position(s) and optional comment in data file

Identical to M122 above except that the m124 reports machine position instead of a local WCS position.

M127 - Record Date and Time in a data file

This M function is used to write the date, time, and year to the specified data file called out by the M120 or M121.

Examples (M function and sample output):

```
M121 "testdata.dat"
M127
```

If you opened testdata.dat you would see: Day of week, Month, day, time, and year.
(i.e. Wed Aug 29 11:56:57 2007)

M128 – Move Axis by Encoder Counts

M128 moves the requested axis by L which specifies an encoder count position or quantity. The L parameter is subject to the current G90/G91 mode (absolute/incremental).

Example:

```
G91 M128/X L-5000           ; move the X axis incrementally by -5000 counts
```

M129 - Record Current Job file path to data file

This M function is used to write the current job's file path to the specified data file called out by the M120 or M121.

Example:

Run a job named job.cnc which contains the following 2 lines:

```
M121 "output.txt"
M129
```

If you opened the output.txt file you would see:

```
c:\cncm\ncfiles\job.cnc
```

M130 - Run system command

This allows shell commands to be called from a CNC program or MDI. M130 takes one string argument which contains the system command to execute.

For example:

```
M130 "mycommand.bat"
will run the batch file mycommand.bat.
```

Normally, the command will run asynchronously, meaning that the G-code program will not wait for the command to finish before continuing. However, if an L1 parameter is given, the command will prevent further G-code execution until a fault occurs (such as E-Stop).

Formatted String Commands- M200, M223, M224 & M225

The formatted string commands are provided to assist in custom screen and file I/O. A “*formatted-string*” is similar to the C programming language “printf” command, with various restrictions. The basic form of a *formatted-string* is a quoted string (comprised of a **single** line of up to 1024 characters) followed by a (possibly empty) list of user and/or system variable expressions. The variable expression is a '#' character followed by a number or bracketed expression.

For example, given #100 = 88* (ASCII 'X'), #300 = “absolute”, and #101 = 1.2345, this string:

```
"The %c* axis %s position is %f" #100 #300 #101
evaluates to
"The X* axis absolute position is 1.23450"
```

The “%c”* is replaced by the ASCII character value of user variable #100, the “%s” is replaced by the string user variable #300, and the “%f” is replaced by the value of user variable #101.

Type specifiers

The 's', 'c', and 'f' are type specifiers, with 's' specifying a string user variable, 'f' specifying a floating point user variable, and 'c' specifying a single character substitution using the integer part of a floating point user variable. There should be one user variable expression for every '%' character in the quoted string. It is also possible to specify a field width by inserting a number between the '%' and the type specifier.

Example:

%20s – specifies that the substituted string is displayed in a field 20 characters long, right justified and padded with spaces on the left. Use “%-20s” for left justification.

The 'f' type can specify a precision such as:

- “%.4f” - display number rounded at the fourth decimal place.
- “%9.4f” - as above but in a field width nine characters wide.
- “%+9.4f” - as above with an '+' output if variable is positive.
- “%.0f” - display number rounded to integer

If no precision is specified, “%f” will use a default precision of the current DRO display precision.

Special characters

The quoted string may contain one or more “\n”, each of which will be converted to a single newline character. Up to seven newlines can be specified in a single formatted string. However, a formatted string may not contain an embedded quote character "" or other *printf*-style escape sequences such as '\t', '\\', or '\'. If a quote character is desired, use a %c type specifier with a variable expression equal to 34.

User string variables #300-#399: These variables can be assigned a quoted string up to 80 characters in length and are retained until the CNC software is exited. For example,

```
#300 = "This is a text string of characters"
```

*The above method of representing an axis label should be used only when writing to an external file or for display in a message box. It is not valid if you are attempting to “build” a motion command in real-time from within the currently running g code program. If your intent is to use a variable to represent an axis label for a real-time command, you should instead use \$ as the placeholder. The parser will replace a '\$' character and the numerical expression following it with the ASCII character equivalent to the numerical expression, provided that it evaluates to the characters 'A' (65) through 'Z' (90). If the numerical expression is out-of-bounds, an “Invalid character” error occurs.

Example: Given #100 = 88, #101 = 1, #102 = 89, #103 = 2, and #104 = 10,
G1 \$[#100][#101] \$[#102][#103] F[#104] evaluates to G1 X1 Y2 F10

M200/M201 – Stop for Operator, Prompt for Action

M200 is used to pause the currently running job and prompt the operator for action. If M0_jogging is unlocked, or the control is in DEMO mode, jogging is enabled while waiting for the operator to respond. If this option has not been enabled, the behavior will default to that of a standard M0. (jogging disabled)

The syntax is: M200 *formatted-string* [[*user_var_expr*] ...]

Example:

M200 “Please jog the %c and %c axes to the desired X0, Y0 position\nPress Cycle Start to continue” #100 #101

M201 behaves exactly like M200 except that PLC bits SV_PROGRAM_RUNNING, SV_MDI_MODE, and SV_JOB_IN_PROGRESS are turned off while the prompt is displayed.

M223 – Write Formatted String to File

The M223 command writes a *formatted-string* to a file that was opened using the M120 or M121 commands. The syntax is:

M223 *formatted-string* [[*user_var_expr*] ...]

Example:

M223 “; The measured diameter of the pocket = %.4f\n” #100

M224 – Prompt for Operator Input Using Formatted String

The M224 command displays a *formatted-string* and then accepts user input. The syntax is:

M224 *lvalue_expr formatted-string* [[*user_var_expr*] . . .]

Where *lvalue_expr* is a *user_var_expr* that evaluates to a user variable that can be written. If *lvalue_expr* is a string type (#300-#399) then the user input is assigned verbatim to the string. Otherwise, the user input is evaluated as any other “bracketed” numerical expression.

Example:

M224 #300 “Please enter the direction that you wish to probe in the %c axis: (+ or -)” #100

M225 – Display Formatted String for A Period of Time

The M225 command displays a *formatted-string* for a specified period of time. The syntax is:

M225 time_expr formatted-string [user_var] ...

where *time_expr* is a *user_var_expr* that evaluates to a floating point variable specifying the number of seconds to display the output, with a value of zero interpreted as indefinitely. The CYCLE_START key can be used to immediately continue running without waiting for the time to expire.

Example:

M225 #100 “Warning, %s is not selected\nPlease select %s and press Cycle Start to continue” #300 #300

M300 – Fast Synchronous I/O update

There are 32 user definable fast system integer variables that can be used to communicate with the PLC (similar to M94 and M95), but without causing motion to decelerate to a stop* (unlike M94 and M95). The syntax is:

M300 /nn /vvv

where *nn* is 1-32 and *vvv* is a 32-bit signed integer value. The parameter *nn* (1-32) maps to system variables SV_FSIO1 - SV_FSIO32. These commands work in conjunction with a PLC program that can read the SV_FSIOx and act upon them.

Example:

M300 /21 /-1234 ; set SV_FSIO21 to integer value -1234

* NOTE: Motion will be decelerated to a stop if Smoothing is turned on (P220 = 1).

M1000-M1015 – Graphing Color for Feedrate movement

When a CNC program is graphed (F8 from the Main Screen), feedrate movements are normally plotted using the color yellow. This color setting can be changed to another color as stated in the chart below.

M Code	Feedrate Graphing Color
M1000	black
M1001	Navy blue
M1002	green
M1003	teal
M1004	orange
M1005	blue
M1006	lime
M1007	aqua

M Code	Feedrate Graphing Color
M1008	maroon
M1009	purple
M1010	olive
M1011	gray
M1012	red
M1013	fuschia
M1014	yellow
M1015	white

Changing this feedrate graphing color can be used as a method highlighting or hiding parts of a graphed CNC program, but will not affect the normal run of the program (when the CYCLE START button is pressed on the Main Screen). The limitations to using these M codes are as follows: These M codes cannot be placed on the same line as another M code, and also the rapid (G0) movement color cannot be changed.

Chapter 14

Configuration

WCS #1 (G54)	Current Position (Inches)	Job Name : bracket.cnc
X	+4.0000	Tool : T001 H001
Y	+2.0000	Feedrate : 100%
Z	-0.5000	Spindle : 0 M
		Stopped Waiting for PLC operation
		Press CYCLE START to start job
Configuration		
Contrl F1	Mach. F2	Parms F3
PID F4	Test F5	ATC Init F6
		DSP Probe F7

General

The first four options, **F1** through **F4**, will display a set of parameters. Each option is explained in detail below. The **ESC** key will return you to the previous screen (Setup).

The configuration option provides you with a means for modifying the machine and controller configuration. The majority of information in this section should not be changed without contacting your dealer. The **F5 - Test** key should only be used by qualified factory technicians to perform automated system tests.



WARNING

Some of the data, if corrupt or incorrect, could cause personal injury or machine damage.

Password

When you press **F3 - Config** from the Setup Screen, you may be prompted to enter a password. This level of security is necessary so that users do not accidentally change vital parameters. The original default password is distributed in the documentation provided to the owner of the machine when the control is installed. This password is changeable via Parameter 42.

If you know the password, type it and press **ENTER**. If the password you enter is incorrect, a message will appear telling you the password was incorrect and the password prompt will reappear. Pressing **ESC** will remove the prompt.

If you don't know the password, simply press **ENTER**. You will be given access to the configuration options so that you can view the information. However, you will not be able to change any of the data.

Control Configuration

Pressing **F1 - Control** from the configuration screen will display the Control Configuration screen. The Control Configuration screen provides you with a method of changing controller dependent data. Each of the fields is discussed in detail below.

If you wish to change a field, use the up and down arrow keys to move the cursor to the desired field. Type the new value and press **ENTER**, or press the **SPACE** bar to toggle. When you are done editing, press **F10 – Save** to save any changes you have made. If you wish to discard your changes and restore the previous values, press **ESC**.

WCS #1 (G54)	Current Position (Inches)	Job Name: a.cnc
X	+0.0000	Tool: T0 H1
Y	+0.0000	Feedrate: 19% 0.0 ipm
Z	+3.0000	Spindle: 0 A
<div style="border: 1px solid black; padding: 2px;">406 Emergency stop detected 301 Stopped 9099 Message Cleared</div>		
Control Configuration		Stall detection disabled
DRO display units:	Inches	(Inches / Millimeters)
Machine units:	Inches	(Inches / Millimeters)
Max spindle (high range):	4000.0	(1.0 to 500000.0 RPM)
Min spindle (high range):	0.0	(0.0 to 500000.0 RPM)
Machine home at pwrup:	Home Switch	(Jog / Home Switch / Ref Mark-HS)
PLC type:	Standard	(Standard / IO2 / RTK2 / None)
Jog Panel type	Jogboard	(Jogboard / Legacy / Offline)
Jog panel required:	No	(No / Yes)
Remote Drive & Directory:	E:\	
Press SPACE to change		
		<div style="border: 1px solid black; padding: 2px; display: inline-block;">Save F10</div>

DRO Display Units

This field controls the units of measure that the DRO displays. The two options are 'Millimeters' and 'Inches.' When this field is highlighted by the cursor, "Press SPACE to change" appears at the bottom of the screen. This message is explaining that pressing the **SPACE** bar will toggle the value of this field between the two options.

The DRO display units do not have to be the same as the machine units of measure (explained below). This field is provided for users of the G20 & G21 codes so that they may view the tool position in terms of job units (see Chapter 12).

Machine Units of Measure

This field controls which units of measure the machine uses for each job. The two options are 'Millimeters' and 'Inches'. Press the **SPACE** bar to toggle the field between the two options.

This field determines the default interpretation of job dimensions and feedrates. If 'Inches' is selected, all feedrates and dimensions will be interpreted as inches as well as any unit dependent parameters.

* NOTE: This field should rarely, if ever, be changed. If you wish to run a job in units other than the default machine units, use the G20 & G21 codes.

Maximum Spindle Speed (High Range)

This field sets the high range maximum spindle speed for those machines that have a variable frequency spindle drive controller (VFD). All spindle speeds entered in a CNC program are sent to the PLC as percentages of this maximum value.

If your machine is equipped with a dual range drive and VFD, the controller will not exceed the spindle speed set by this field while in high gear. See the Machine Parameters section below for information on setting the gear ratios for medium and low gear ranges. If your machine has a VFD but is not equipped with a dual range drive, this field determines the maximum spindle speed.

Minimum Spindle Speed (High Range)

This parameter is used to adjust the minimum spindle speed for the high range. This parameter allows the operator to set the minimum value for spindle speed to a value other than 0. All changes in spindle speed are made in relationship to this value, with this parameter as the minimum value. The values stored can range from 0 to 500000.0 RPM.

Machine Home at Powerup

This field controls how the machine will home at powerup. Set Machine Home at Powerup to Home Switch if you have limit/home switches or safe hard stops for all axes, and wish to use the switches or stops for homing. Set Machine Home at Powerup to Ref Mark – HS if you have fixed reference marks for any axis. In Ref Mark homing, axes that contain a zero (0) for the plus or minus home switch in the Machine Configuration designate that axis to have a Ref Mark home, while non-zero values specify Limit Switch homing. Set Machine Home at Powerup to Jog if you need to manually move or jog the machine to its home position. See Chapter 1 for more information about machine home.

PLC Type

This field tells the controller which PLC type is installed. The available choices are: Standard, Legacy IO2, Legacy RTK2, and None.

Jog Panel Type

This field tells the controller which type of Jog Panel is installed. The available choices are: Jogboard, Legacy, and Offline.

Remote Drive & Directory

This field sets up the remapped default drive and directory for the **F3 - Remote** key in the Load Job screen. This allows you to conveniently load files from an attached computer via LAN network (via RJ-45 Ethernet connection). The Control will usually remap the attached computer's C: hard drive as drive E:, depending on the way it was set up.

User Specified Paths

Operators can now specify paths for INTERCON files, posted INTERCON files, Digitize files and CAD files. These paths are specified in *pathm.ini*. This file is automatically generated by the CNC software if it does not exist. The default *pathm.ini* file is:

```
INTERCON_PATH=c:\intercon\  
ICN_POST_PATH=c:\cncm\ncfiles\  
DIGITIZE_PATH=c:\cncm\ncfiles\  
CAD_PATH=c:\cncm\ncfiles\  

```

Path tag	Purpose of path
INTERCON_PATH	Main directory containing *.icn files
ICN_POST_PATH	Directory INTERCON places *.cnc files created when posting *.icn files.
DIGITIZE_PATH	Directory digitize files are saved to. Directory used by F4 key in Load Job menu when parameter 4 is set to 2.
CAD_PATH	Default directory used by the Import DXF file menu in Intercon. This directory is also used to store CAD files generated with the DIG->CAD option in the Utility menu.

Machine Configuration

Pressing **F2 - Machine** from the configuration screen will display the machine configuration screen. The machine configuration screen provides you with a method of changing machine dependent data.

If you wish to change the Jog or Motor parameters, press **F1 - Jog** or **F2 - Motor** to select the Jog or Motor screens. Use the arrow keys to move the cursor and select the desired field. Type the new value and press **ENTER** or press the **SPACE** bar to toggle. When you are done editing, press **F10 - Save** to save any changes you have made. If you wish to discard your changes and restore the previous values, press **ESC**. Pressing **ESC** again will return you to the previous screen (Configuration).

F1 - Jog Parameters

This screen contains jog and feedrate information. See the figure below.

WCS #1 (G54)	Current Position (Inches)	Job Name: triangle.cnc	Tool: T1 H---	Program #20000			
X	-0.00013	Feedrate: 100%	Part Cnt: 0				
Y	+0.00000	Spindle: +0 A	Part # <input type="checkbox"/> 3	Time: 0:00:07			
Z	+0.00000	<pre> 309 Waiting for CYCLE START button 302 Moving... 305 Processing... 302 Moving... 306 Job finished 301 Stopped </pre>					
Jog Parameters							
Axis	Slow Jog (in/min)	Fast Jog (in/min)	Max Rate (in/min)	Deadstart (in/min)	Delta Vmax (in/min)	Travel (-) (Inches)	Travel (+) (Inches)
1	5	100	300	0.1000	0.1969	0.0000	0.0000
2	5	100	300	0.1969	0.1969	0.0000	0.0000
3	5	100	300	0.1969	0.1969	0.0000	0.0000
4	5	1	300	0.1969	0.1969	0.0000	0.0000
5	5	1	333	0.1969	0.1969	0.0000	0.0000
6	5	1	333	0.1969	0.1969	0.0000	0.0000
7	5	1	333	0.1969	0.1969	0.0000	0.0000
8	5	1	333	0.1969	0.1969	0.0000	0.0000
Save							
F10							

A description of each of these parameters is listed below.

* NOTE: Some of these values are set automatically by the Autotune option (See PID Menu later in this chapter).

Slow Jog: Determines the speed of motion on an axis when slow jog is selected and a jog button is pressed. The slow jog rate cannot be set to a value greater than the maximum rate.

Fast Jog: Determines the speed of motion on an axis when fast jog is selected and a jog button is pressed. The fast jog rate cannot be set to a value greater than the maximum rate.

Max Rate: Determines the maximum feedrate of each individual axis. The feedrate on each axis can never exceed Max Rate, even if the feedrate override knob on the front panel is turned up above 100%. (See also the Machine Parameters section for the "Multi-Axis Max Feedrate" parameter that limits the feedrate along move vectors, not just each individual axis.)

* NOTE: The maximum rate may be set to a smaller value if you wish to run your machine at a slower rate.

Deadstart: Determines the speed an axis will decelerate to before stopping or reversing direction. A low setting will cause a large slowdown before a reverse in direction, causing your machine to be more accurate. A high setting will cause less slowdown before reversals, but this may cause your machine to "bang" which may cause a decrease in accuracy. This parameter should not be changed.

Delta Vmax: The maximum instantaneous velocity change that will be commanded on a vector transition. This parameter should not be changed.

Travel (-): The maximum distance the axis can travel in the minus direction from the home position. Set this parameter to create a software limit that stops the axis before the fixture or tool collides with the limit switches or hard stops.

Travel (+): The maximum distance the axis can travel in the plus direction from the home position. This parameter is especially useful when using a part or fixture larger than the table. Set this parameter to create a software limit that stops the axis before the fixture or part collides with the machine or the limit switch/hard stop.

F2 - Motor Parameters

This screen contains information about the motors, ballscrews, and switches installed on your machine. See the figure below.

WCS #1 (G54)
Current Position (Inches)
Job Name: triangle.cnc

X
· 0.00025
Tool: T1 H---
Program #20000

Y
+0.00000
Feedrate: 100%
Part Cnt: 0

Z
+0.00005
Spindle: +0 A
Part # □: 3

Time: 0:00:07

309 Waiting for CYCLE START button
 302 Moving...
 305 Processing...
 302 Moving...
 306 Job finished
 301 Stopped

Motor Parameters

Axis	Label	Motor revs/in	Encoder counts/rev	Lash Comp. (Inches)	Limit		Home		Dir Rev	Screw Comp
					-	+	-	+		
1	<input checked="" type="checkbox"/>	1.00000	8000	0.00000	0	0	0	0	N	N
2	Y	5.00000	8000	0.00000	0	0	0	0	N	N
3	Z	5.00000	8000	0.00000	0	0	0	0	N	N
4	N	5.00000	8000	0.00000	0	0	0	0	N	N
5	s N	5.00000	8000	0.00000	0	0	0	0	N	N
6	N	5.00000	8000	0.00000	0	0	1	2	N	N
7	N	5.00000	8000	0.00000	0	0	1	2	N	N
8	N	5.00000	8000	0.00000	0	0	1	2	N	N

Save
F10



WARNING

The Motor Parameters should not be changed without contacting your dealer. Corrupt or incorrect values could cause damage to the machine, personal injury, or both.

Special function indicators: These appear, if present, between the axis number and the label. 's' – indicates the axis is the spindle, 'p\$' – axis is paired with axis '\$', '*' – pairing conflict. See Machine Parameters for more information on setting up special functions.

Label: The letter you want to use to identify the axis. The first three axes should normally be X, Y, and Z. If a fourth axis is installed, it is usually named W or B. If you change a label, for example from X to A, the controller will then accept G-codes for axis A instead of X.

If fewer than four axes are present, the unused entries should be labeled N. If an axis is manually operated (it has an encoder but no motor), it should be labeled M.

For a manual Z-axis, the 3rd axis label should be set to @ symbol. This setting allows for two axes posting in Intercon.

* **WARNING:** Intercon does NOT post two axis programs if the 3rd axis is labeled M.

* **NOTE:** Tool length compensation (G43-G44) and canned drilling cycles (G73-G89) always affect the third axis, regardless of its axis label. Tool diameter compensation (G41-G42) always affects the first and second axes, regardless of their axis labels.

Motor revs/inch OR millimeters/motor rev: The number of revolutions of the motor that results in one inch of movement (if the machine is set up in inches). OR the number of millimeters that the machine will move as a result of one turn of the motor (if the machine is set up in millimeters).

Encoder counts/rev: The counts per revolution of the encoders on your servomotors.

Lash compensation: The uniform amount of backlash compensation to be applied along the whole length of the axis. Backlash can be observed during axis direction reversals and is a normal occurrence due to looseness or wear of moving parts in a machine. This parameter added to and works in conjunction with Screw Compensation (see below). Consult your machine manual or M-Series Service Manual for instructions on measuring backlash. The Lash Acceleration Coefficients, Parameters 208-215, can be used to change the speed that Lash Compensation is applied. A Coefficient of zero will effectively disable Lash Compensation.

* **NOTE:** It is required that the machine be **rehomed** after changing Lash Compensation.

Limits: The PLC input numbers corresponding to any limit switches that you may have on your machine. Your installer should provide this information. If no limit switch is installed, this field should be set to 0.

Home: The PLC input numbers of any Home Switches you may have. These are similar to the limit switches. If your machine does not have home switches, this field should be set to the Limit Switch value. If no home or limit switch is installed, this field should be set to 0. You may then use hard stops as homing points if you choose.

* **NOTE:** The Home Switch should never be physically located beyond the Limit Switch.

Direction reversed: Used to match the +/- reference of your machine to the control electronics. Toggle this value if you actually move in the X minus direction (reverse) when you jog X+.

Screw Compensation*: This value indicates whether mapping ballscrew compensation is enabled. Screw Compensation is similar to Lash Compensation (see above), but has differing compensations depending on the mapped locations along the axis. Screw Compensation is added to and works in conjunction with Lash Compensation. For more information, contact your dealer. It is recommended that you enable ballscrew error compensation at all times.

* **NOTE:** It is recommended that a rehoming of the machine be done after changing Screw Compensation.

F3 - Find Home Press **F3-Find Home** to move an axis to its plus or minus home switch.

F4 - Set Home Press **F4-Set Home** to set Machine Home for an axis at its current position. This is usually performed after Find Home. This operation should not be used to set the part zero position. To set the part zero position, use the Part Setup screen.

F5 – M Comp This menu lets you edit the ballscrew compensation tables.

NOTICE The ballscrew compensation tables **should not** be changed without contacting your dealer. Corrupt or incorrect values could adversely affect the accuracy of the positioning of your machine.

F7 – Scales This menu lets you set up scale encoders for the purpose of applying scale encoder correction to one or more axes.

WCS #1 (G54) Current Position (Inches) Job Name: triangle.cnc
 X +10.00013 Tool: T1 H---
 Y +0.00000 Feedrate: 100% Part Cnt: 0
 Z +0.00000 Spindle: +0 A Part # □: 3

304 MDI...
 302 Moving...
 304 MDI...
 307 Operator abort: job cancelled
 304 MDI...
 301 Stopped

Press CYCLE START to start job

Scale Settings

Axis	Label	Input	Enabled	Scale Counts/Inch	Ratio	Deadband	Velocity
1	X	0	N	0.0000	0.0000	0	0.0000
2	Y	0	N	0.0000	0.0000	0	0.0000
3	Z	0	N	0.0000	0.0000	0	0.0000
4	N	0	N	0.0000	0.0000	0	0.0000
5	N	0	N	0.0000	0.0000	0	0.0000
6	N	0	N	0.0000	0.0000	0	0.0000
7	N	0	N	0.0000	0.0000	0	0.0000
8	N	0	N	0.0000	0.0000	0	0.0000

Save
F10

NOTICE The Scale Settings **should not** be changed without contacting your dealer. Corrupt or incorrect values could adversely affect the accuracy of the positioning of your machine.

Axis and Label are for informational purposes to indicate on which axis the scales will be applied. These values cannot be modified on this screen.

Input is the scale encoder number based on the map shown on parameters 308-315. Numbers 1-6 are on the MPU11 and 7-14 are on Optic4 drives. If spare headers are available on the Optic4, they can be used for scale feedback.

Enabled Y enables the scale and N disables the scale.

Scale Counts/Unit is the number of counts of the scale per unit of measurement. This value should come directly from the scale data sheet and should be entered in the control units. If the control is in inches, then the value should be entered in inches.

Ratio is calculated as [(Motor Encoder Counts per Rev. * Motor Rev. per Unit) / Scale Counts per Unit] and cannot be modified. It shows how close the counts/unit are between the motor encoder and scale encoder.

Deadband is the number of encoder counts away from the commanded position that the scale position can be before compensating. Typically an integer multiple from 1 to 3 times the Ratio should be used.

Velocity is the number of motor encoder counts / interrupt at which the Scales should adjust the position. Typically a value of 0.5 is a good starting value. To figure out a value to use based on a units/min. speed you need to convert it. The equation is [units/min. * Motor Encoder Counts per Rev. * Rev. per unit * (1min/60 sec.) * (1sec./4000 int)]. Due to the nature of scale feedback it is inherently an oscillator and by adjusting the Deadband and Velocity that oscillation can be kept to a minimum.

Scale Indicator Changing the Input, Enabled, or Scale Counts/Unit fields will cause scale compensation to be temporarily disabled. Scale compensation is also temporarily disabled during homing moves. Even though the scale is enabled in the menu, scale compensation will be disabled until the axis is rehomed. When a scale is configured for an axis, a scale indicator appears below the axis label on the DRO. It will have a green background when the scale is enabled and a red background when the scale is disabled.

X +0.0000

Machine Parameters

(F3 - Parm from Configuration)

Machine Parameters 0 - 99									
0	0.0000	20	72.0000	40	0.0001	60	0.0000	80	0.0000
1	0.0000	21	0.0400	41	0.2500	61	0.5000	81	-1.0000
2	0.0000	22	0.0400	42	54.0000	62	115.0000	82	1000.0000
3	0.0000	23	0.0400	43	0.0250	63	1.5000	83	0.0500
4	5.0000	24	0.0400	44	0.0010	64	0.0000	84	3.0000
5	0.0000	25	0.6800	45	0.0000	65	1.0000	85	1.0000
6	1.0000	26	0.6800	46	0.0000	66	1.0000	86	0.0000
7	1.0000	27	0.6800	47	1.0000	67	1.0000	87	36.0000
8	3.0000	28	0.6800	48	0.1000	68	640.0000	88	36.0000
9	0.0000	29	150.0000	49	0.0000	69	1.7500	89	36.0000
10	0.0000	30	180.0000	50	1.0000	70	0.0010	90	36.0000
11	15.0000	31	-1.0000	51	0.0000	71	0.0000	91	0.0000
12	10.0000	32	19200.000	52	0.0010	72	0.0000	92	0.0000
13	0.0500	33	1.0000	53	0.0100	73	0.1000	93	0.0000
14	30.0000	34	-8000.0000	54	0.0000	74	4.0000	94	0.0000
15	6.0000	35	3.0000	55	0.0000	75	0.0000	95	4.0000
16	10.0000	36	1.0000	56	32000.000	76	0.0000	96	4.0000
17	3.0000	37	3.0000	57	0.0000	77	0.0000	97	4.0000
18	10.0000	38	0.0000	58	179.9500	78	0.0000	98	2.0000
19	0.0000	39	200.0000	59	0.0100	79	49.0000	99	2.0000

E-Stop PLC Bit Number

Prev.
Table
F7

Next
Table
F8

Save
F10

This screen provides you with a method of changing various parameters that are used by the control. Altogether, you have access to 500 parameters spread across 5 tables. Each table gives you access to 100 parameters at a time. You can navigate between tables using the following keys: **F7-Previous Table** and **F8-Next Table**. The title at the top tells you which table you are on. If you wish to change a field in the table, use the arrow keys to move the cursor and select the desired field. A short description of the parameter will appear below the table. Type the new value and press **ENTER**. When you are done editing the fields, press **F10-Save** to accept any changes you have made and save them. Note that **F10-Save** is a single operation that will save all changes in every table that you modified. Pressing **ESC** will discard all changes in every table that were modified and will return to the previous menu [Setup].

- NOTE: Many machine parameters can also be set with the G10 G-code or by #variable assignment.

Bit-mapped parameters

Certain control parameters are defined by bit-mapped values. In order to change these parameters you must understand how bit mapping works. A bit-mapped parameter is stored as a number, representing a 16-bit value in the control. If a certain bit needs to be turned on, that bit's binary value must be added to the parameter value, if the bit needs turned off, its binary value must be subtracted from the parameter value. The values for each of the 16 bits' can be seen in the table below.

Bit-Mapped Parameter Bits																
Bit	15	14	13	12	11	10	9	8	7	6	5	4	3	2	1	0
Value	32768	16384	8192	4096	2048	1024	512	256	128	64	32	16	8	4	2	1

To set bit-mapped parameters simply add together the bit values that you need to have enabled.

Examples:

Parameter value	Bit number and settings															
	15	14	13	12	11	10	9	8	7	6	5	4	3	2	1	0
0	X	X	X	X	X	X	X	X	X	X	X	X	X	X	X	X
1	X	X	X	X	X	X	X	X	X	X	X	X	X	X	X	ON
11 = 8+2+1	X	X	X	X	X	X	X	X	X	X	X	X	ON	X	ON	ON
24 = 16+8	X	X	X	X	X	X	X	X	X	X	X	ON	ON	X	X	X

The following parameters are currently defined:

Parameter	Definition	Default setting
0	E-Stop PLC Bit	0
1	Y jog key orientation	0
2	G-Code Interpretation Control and Slaving Rotary axis feedrate	0
3	Modal Tool and Height Offset Control	0
4	Remote File Loading Flag & Advanced File Ops	0
5	Suppress Machine Home Setup	0
6	Auto Tool Changer Installed	0
7	Display Colors	0
8	Available Coolant System(s)	2
9	Display Language	0
10	Macro M-Function Control/Probe Stop Handling	0
11	Touch Probe PLC Input	15
12	Touch Probe Tool Number	0
13	Probing Recovery Distance	0.05" / 1.27 mm
14	Fast Probing Rate	10 ipm or 254 mm/min
15	Slow Probing Rate	1 ipm or 25.4 mm/min
16	Probing Search Distance	10" / 254 mm
17	Tool Detector Reference Number	0
18	PLC Input Spindle Inhibitor	0

Parameter	Definition	Default setting
19	MPG modes	0
20	Ambient Temperature	72°F / 22°C
21-24	Motor Heating Coefficients for axes 1,2,3,4	Refer to text
25-28	Motor Cooling Coefficients for axes 1,2,3,4	Refer to text
29	Warning Temperature	150°F / 65.5°C
30	Limit Temperature	180°F / 82°C
31	Legacy SPIN232 Com Port	0
33	Spindle Motor Gear Ratio	1
34	Spindle Encoder Counts/Rev	8,000
35	Spindle Encoder Axis Number	0
36	Rigid Tapping Enable/Disable	0
37	Spindle Deceleration Time	10
38	Multi-Axis Max Feedrate	0
39	Feedrate Override Knob Limit	120
40	Basic Jog Increment	0.0001" / .001 mm
41	Rotary Axis Jog Increment	.01°
42	Password for Configuration Menus	0
43	Automatic tool measurement options	0
44	TT1 PLC input #	0
48	Grid Digitize Patch Playback Z rapid clearance amount	.1
49-51	Small Arc Feedrate Limiting	0
56	Feedrate Override Display Properties	0
61	High Power Stall Timeout	0.5
62	High Power Stall PID Limit	115
63	High Power Idle PID Multiplier	1.5
64	4 th /5 th Axis Pairing	0
65-67	Spindle Gear Ratios	1.0
68	Minimum Rigid Tapping Spindle Speed	0
69	Duration For Minimum Spindle Speed	1.0
70	Offset Library Inc/Decrement Amount	.001" / .02 mm
71	Part Setup Detector Height	0
72	Data Recording M-Function Options	0
73	Peck Drill Retract Amount	0.05
74	M-Function executed at bottom of tapping cycle	4
75	Axis Summing Control	0
76	Manual Input Unrestricted Distance	0
77	Manual Input Movement Tolerance	0
78	Spindle Speed Display and Operations	0
80	Voltage Brake Applied Message Frequency	0
81	Air Drill M-Function (executed instead of Z movement in drilling)	-1
82	Spindle Drift Adjustment	0
83	Deep Hole Clearance Amount	0.05
84	M-Function executed at return to initial point of tapping cycle	3
85	"Door Open" Interlock PLC bit	0
86	Rapid/Linear vector rate limit	0
87-90	Autotune Ka Performance parameters for axes 1,2,3,4	0
91-94	Axis Properties for axes 1,2,3,4	0

Parameter	Definition	Default setting
95-98	Autotune / Auto Delay Move Distance for axes 1,2,3,4	2" / 50.8 mm
99	Cutter Compensation Look-ahead	6
100	Intercon comment generation	0
101	Intercon clearance amount	0.1
102	Intercon spindle coolant delay	3.0
103	Intercon corner federate override	50.0
104	Intercon modal line parameters	0
105	Intercon modal arc parameters	0
106	Intercon modal drilling cycle parameters	0
115	Intercon Help	0
116	A-Axis Y Coordinate	0
117	A-Axis Z Coordinate	0
118	B-Axis X Coordinate	0
119	B-Axis Z Coordinate	0
120	Probe stuck clearance amount	0.10" / 2.54 mm
121	Grid digitize prediction minimum Z pullback	0.002" / .0508 mm
122	Grid digitizing deadband move distance	0.0002" / .00508 mm
123	Radial digitizing clearance move	0
130	Z axis on/off selection	0
131	4 th axis on/off selection	0
132-135	Motor Heating Coefficients for axes 5,6,7,8	Refer to text
139	Special Dwell between Moves	0
140	Message log priority level	1
141	Maximum message log lines	100
142	Message log trim amount	100
143	DRO properties (load meters, 4/5 digits, DTG)	0
144	Comparison rounding	0
145	Advanced macro properties (fast branching)	0
146	Feed hold threshold for feed rate override	0
147	Number of Messages in Operator Message Window	10
148	Miscellaneous Jogging Options	0
149	Spindle Speed Threshold	1.0
150	Backplot Graphics display options	0
151	Repeatability tolerance for probing	0
155	DSP Probe Installed	0
156-159	Autotune / Auto Delay Move Distance for axes 5,6,7,8	2" / 50.8 mm
160	Enhanced ATC	0
161	ATC Maximum Tool Bins	0
162	Intercon M6 Initial M-Code	0
164	ATC Feature Bit	0
165	Acceleration/Deceleration Options	0
166-169	Axis Properties for axes 5,6,7,8	0
170-177	PLC parameters	0
178	PLC I/O configuration (PLC program specific)	0
179	Lube Pump Operation	0
186	Probe Stuck retry disable	0
187	Hard Stop Homing Power Limit	0

Parameter	Definition	Default setting
188-199	Aux key functions	0
200-207	OPTIC4 Tach Volts Per RPM	0
208-215	MPU Lash/Screw Comp Acceleration Coefficient	0.125
216	PC Based Lash Compensation on/off	0
217	PC Based Screw Compensation on/off	0
220-231	Smoothing Parameters	Refer to text
236-239	Motor Cooling Coefficients for axes 5,6,7,8	0
252-255	Autotune Ka Performance parameters for axes 5,6,7,8	0
256	Drive Mode	0
257	TT1 connection detection PLC input	0
258	Velocity/Torque Mode override in Precision mode	0
260	Accelerated Graphics Backplot on/off	1
270	Skew Correction: X Skew offset from Trusted/Intended X	0
271	Skew Correction: Trusted/Intended Y	0
284-291	Brake Resistor Wattage for ACDC Drives 1-8	50
300-307	Drive assignment to Axes 1-8	Refer to text
308-315	Encoder assignment to Axes 1-8	Refer to text
323	MPU11 Encoder Speed Filter	0
324-331	Axis Boxcar size	0
332-335	Encoder error suppression	0
336-339	Motor torque estimation for velocity mode drives	Refer to text
340-347	Precision Mode delay (in milliseconds) for axes 1-8	0
348,351,354	MPG 1,2,3 Encoder Input	15, 0, 0
349,352,355	MPG 1,2,3 Detents per Revolution	100
350,353,356	MPG 1,2,3 Encoder Counts per Revolution	400
357-364	Axis Drive Max RPM	0
365	Drive power-on delay	0.0
366	Probe deceleration multiplier	2.0
367	TT1 deceleration multiplier	2.0
374	ACDC Drive Debug Log Axis Inclusion	0
375	ACDC Drive Debug Log Size	0
376	ACDC Drive Debug Log Collection Type	0
377	ACDC Drive Debug Log Trigger Type	0
378	ACDC Drive Debug Log Trigger Level	0
379	ACDC Drive Debug Log Option	0
392-394	DP-7 parameters	Refer to text
395	Probing setup traverse speed	30 ipm or 762 mm/min
396	Probing setup plunge speed	30 ipm or 762 mm/min
398	Port/block mode	0
399	AD1 arc chord tolerance adjustment	.5
900-999	PLC program parameters	--

Parameter 0 – E-Stop PLC Bit

This parameter specifies the PLC bit to which the physical Emergency Stop switch is connected. It is mainly used for ATC applications that use custom PLC messages. See table below for examples.

PLC Type	ESTOP Input on PLC	Parameter Value
RTK3	Input 11	-11
PLCIO2	Input 11	-11
DC3IO	Input 11	-11
Servo3IO	Input 1	1

Parameter 1 – Y jog key orientation

This parameter is a 3-bit field where bit 0 is not used in the mill software. Bit 1 sets the direction of movement for the Y+ and Y- jog keys and bit 2 will swap the X and Y jog keys. This should always be set to 0 except for very special applications. Note: PLC program interaction is needed for these features.

Bit	Function Description	Parameter Value
0	Not Used	
1	Flip direction of Y jog keys?	Yes=2, No=0
2	Exchange X axis and Y-axis jog keys?	Yes=4, No=0

Parameter 2 - G-code Interpretation Control and Slaving Rotary axis feedrate

This parameter is a bit field that controls optional interpretation of several G-codes. The following table shows the functions performed by the value entered in this parameter:

Bit	Function Description	Parameter Value
0	Arc centers I, J, K are absolute in G90 mode?	Yes = 1 No = 0
1	Allow Z being specified alone to be sufficient to trigger execution of a canned tapping or drilling cycle to be executed?	Yes = 2 No = 0
2	Interpret dwell times associated with G4, G74, G82, G84, and G89 as milliseconds rather than seconds?	Yes = 4 No = 0
3	Slaving rotary axis feedrate to non-rotary axis feedrate Note that this feature has no effect for movement commands handled by Smoothing (when parameter 220=1).	Yes = 8 No = 0
4	Selects the center for scale, mirror and rotate. By default the center will be 0,0,0. Add 16 to this parameter to make the center of scale, mirror and rotate the current position.	Yes = 16 No = 0
5	Prevent rotary-only moves (rotary axis by itself on a line of G-code) from acquiring a remembered slaved rotary feedrate previously set by a previous line of G-code containing a rotary and non-rotary together. Note that this feature has no effect for movement commands handled by Smoothing (when parameter 220=1).	Yes = 32 No = 0

Parameter 3 - Modal Tool and Height Offset Control

Bit	Meaning	Parameter Value
0	Tool and Height Offset numbers, T and H, will be reset upon job completion (and not remain modal and active between jobs).	Reset upon job completion = 1, Remain modal between jobs = 0
1	Reference tool position is set to Z home.	Yes = 2 No = 0
2	Tool Height Offset Retention option. This option prevents the current tool height offset from being turned off when the user enters the Tool Height Offset menu. Additionally, this option will cause the H height offset to be set to match the tool number when an Auto Tool Change is performed (via F7 ATC) in the Offset Library.	Turn on Tool Height Offset Retention option = 4, No = 0

Parameter 4 - Remote File Loading Flag & Advanced File Ops

This parameter controls the action of the Load Job menu when CNC job files are selected from drives letters higher than C. These drives (i.e. drives D, E, F, etc.) are presumed to be network drives or extra hard drives.

Value	Meaning
0	Job files are not copied or cached. They are run from whichever drives they reside on.
1	Job files are copied to the C drive (c:\cncm\ncfiles) when they are loaded. The local copy is used when the job runs.
2	Turn on file caching. Job files are temporarily cached on the C drive. The cached copy is used while the job is running. The cached copy is deleted when the next job is loaded or when Parameter 4 changes to a 0 or 1. Digitize files are cached as the machine is digitizing. When digitizing is complete, the resulting file is copied to the digitize directory specified in <i>pathm.ini</i> .
4	Set the Advanced File load menu as default for loading files
8	Use Windows-style File Open dialogue

File caching is useful for machines with both a flash card and a hard drive. By caching job files from the hard drive on the flash card, the hard drive is not used while the job is running. As a result, the life of the hard drive is extended and the flash card does not fill up with job files.

Parameter 5 - Suppress Machine Home Setup

This parameter controls machine homing upon startup of the control. The following table details the functions controlled by this parameter:

Bit	Function Description	Parameter Value
0	Suppress the requirement to set machine home before running jobs?	Yes = 1 No = 0
1	Display router bit map at homing screen	Yes = 2, No = 0
2	Disable stall detection when the CNC software first starts.	Yes = 4, No = 0

Bit 0 suppresses the requirement to set machine home before running. If bit 0 of Parameter 5 is 0, machine home must be set before jobs may be run. If bit 0 of Parameter 5 is 1, machine home is not requested or required, but Graphing and running of jobs will not work until the Z-axis is homed.

NOTE: Parameter 5 Bit 0 is separate from the "Machine Home at Powerup" flag in the Control Configuration Screen. Parameter 5 Bit 0 determines **whether** you must home the machine; the "Machine Home at Powerup" flag determines **how** you will home the machine, if you must do so.

Parameter 6 - Automatic Tool Changer Installed

This parameter tells the control whether an automatic tool changer installed on your machine. This field affects the action of M6 in your CNC programs. See M6 under M functions in Chapter 13. It also affects whether the ATC key is present in the Tool Offset Setup and whether to save the last tool change number in the job files.

Value	Meaning
0	Auto Tool Changer NOT Installed
1	Auto Tool Changer Installed

Parameter 7 - Display Colors

This parameter determines what combination of colors will be used for display. If you have a color display, set this parameter to 0. If you have a monochrome display (especially a monochrome LCD panel) set this parameter to 1.

Parameter 8 - Available Coolant Systems

This parameter is used by Intercon to determine what coolant systems are available on the machine. It should be set as follows:

Value	Meaning
1	Mist Coolant (M7) only
2	Both coolant systems
3	Flood Coolant (M8) only

Parameter 9 - Display Language

This parameter determines what language will be used for menus, prompts and error messages.

Value	Meaning
0	English
1	Spanish
2	French
3	Traditional Chinese
4	Simplified Chinese
5	German
6	Swedish
7	Finnish
8	Portuguese
9	Greek

Parameter 10 - Macro M function handling/Probe Stop Handling

This parameter is a bit field that controls various aspects of M functions. The following table shows the functions performed by the value entered in this parameter. The default value is 0.

Bit	Function Description	Parameter Value
0	Display M & G codes in M function macros?	Yes = 1, No = 0
1	Step through M function macros in Block Mode?	Yes = 2, No = 0
2	Decelerate to stop on M105 and M106. With decel.set these moves take longer and are slightly less accurate. With immediate stop these moves are faster and more accurate; however the lack of controlled deceleration can cause excessive machine vibration.	Decel = 4, Immediate Stop = 0
3	Move to Z home on M6?	No = 8, Yes = 0
4	(not used) This bit was previously used for controlling the type of deceleration to stop on digitizing and probing moves. This functionality is now controlled by parameters 366 and 367.	Recommended value = 0

Parameter 11 – DP4 PLC Input Number and Contact State

This parameter is used for the PLC input number that is used by the DP4 Touch Probe. Allowable range is a single value, +/- 1 to 240 and 50001 to 51312. A Positive number indicates Closed on contact and a negative number indicates Open on contact. A list of default settings for different console types are listed below.

NOTICE Changing this parameter can cause damage to your probe. You should contact your Dealer or Local Tech Representative before any modifications are made.

Console Type/Model	Input Number	PLC Type/Model	Input Number
M39	15	DC3IO	14
M39s	14	RTK3	14
M400	15	Servo3IO	2
M400s	14	PLCIO2	15
M15-10	2	15/15	15
M400 ATC (RTK3)	14	RTK2	15
M400 ATC (PLCIO2)	15	Koyo ATC	1
MPU11	50769		

Parameter 12 – Touch Probe Tool Number

This parameter is the tool number of the DP4 probe. Allowable range is 0 through 200. By default the value is 10. This is used to look up the length offset and tip diameter of the probe in the Tool Offset Library.

Parameter 13 – Recovery Distance

This parameter is the distance that the probe moves off a surface after initial contact (only during probing cycles), before returning to the surface to take a recorded reading.

For DSP Probes: This parameter is used for failed DSP windows. On a failed window, the DSP probe will retract this distance before retrying.

Parameter 14 – Fast Probing Rate

The fast probing rate is used for positioning moves and initial surface detection, and is determined by the machines response time and the permitted probe deflection. The default is 10 in/min. This is a very conservative feedrate, in actual use 20 to 30 in/min is a good value and will not have any detrimental impact on accuracy in most cases.

Parameter 15 – Slow Probing Rate

The slow probing rate is used for the final measurement moves. The default setting is 1 in/min. The following are some typical accuracy tolerances with the corresponding value set in parameter 15:

Probing Rate		Accuracy	
0.5 in/min	12.7 mm/min	0.0001 in	.00254 mm
1 in/min	25.4 mm/min	0.0002 in	.00508 mm
1.5 in/min	38.1 mm/min	0.0005 in	.0127 mm
3.5 in/min	88.9 mm/min	0.0010 in	.0254 mm
18 in/min	457.2 mm/min	0.0050 in	.1270 mm

Parameter 16 – Maximum Probing Distance

This is the maximum distance that the Boss and Web probing cycles “search” for a surface in a given direction if no travel limits have been entered. The default setting is 10 inches. A larger value should be entered for the boss and web cycles if you are measuring very large features. These settings are conservative measurements and can be used initially for startup purposes. However, they can be changed to accommodate your work.

Parameter 17 – Detector Location Return Point

A non-zero value specifies the number of the reference return point (entered into the WCS menu) directly above a permanently mounted TT-1 tool detector. When the Auto function is called up in the tool offset library, the control will position the table to the return point specified by this parameter, and touch the tool off the TT-1 Tool detector.

Entry	Return Point
0	None
1	G28
2	G30
3	G30P3
4	G30P4

A zero indicates that the tool detector is no permanently mounted; automatic tool measurement will be performed without X/Y axis movement.

Parameter 18 - PLC Input Spindle Inhibit Parameter

This parameter stores the input for the Spindle Inhibit feature. A negative value must be entered if a "normally closed" probe is to be used with the control. A positive value must be entered if a "normally open" probe is to be used with the control. The absolute value of Parameter 18 will directly reflect the PLC input the Spindle Inhibit is wired to. When this parameter is set, Digitizing and Probing cycles will not run unless a probe or touch-off block is connected. This parameter is used to prevent the tool or probe from crashing into the table. The default for this parameter is 0, which disables this feature.

PLC Type/Model	Input Number
Allin1DC	50771
MPU11	50771
DC3IO/DC3IOB	15
RTK3	15
Servo3IO/M15DRV1	5
PLCIO2	10
15/15	10
RTK2	10
Koyo ATC	2

Parameter 19 - MPG modes

The MPG is a hand-held device that is used as an alternate way of jogging the machine. This parameter defines the MPG's mode of operation.

Bit	Function Description	Parameter Value
2	Enable Z axis MPG* -- This will allow the z-axis to be moved with the MPG while running a job independent of the x and y axes	Yes = 4, No = 0

*PLC program interaction is needed for these features. The plc program is in direct control of MPG modes. Z-axis MPG operation is not available with all controls.

Parameters 20-30 (also 132-135, 236-239) - Motor Temperature Estimation

These parameters are used for motor temperature estimation. Parameters 20, 29 and 30 correspond respectively to the ambient temperature of the shop, the overheating warning temperature, and the job cancellation temperature, all in degrees Fahrenheit. Parameters 21-24 and 132-135 are the heating coefficients. Parameters 25-28 and 236-239 are the cooling coefficients.

To disable Motor Temperature Estimation for an axis, set its heating and cooling coefficients to 0. For example, to disable Motor Temperature Estimation for axis 1, set Parameter 21 to 0, and set Parameter 25 to 0.

Note: Temperature estimation only applies to controls operating in Torque mode (i.e. DC brushed systems and Centroid AC systems). MPU11 systems running in Velocity mode (i.e. third party drive systems) do not use this feature, and thus should be disabled (by setting all heating and cooling coefficients to 0).

Suggested values for AC Brushless Motors and Drives						
SD Drive		SD3, SD1 750 W motors	SD3, SD1 1,2 KW motors	SD3, SD1 (finned heatsink) 1,2 KW motors	SD1 45A (finned heatsink) 3 KW motors	SD1 45A (finned heatsink) 4 KW motors
Parameters	Axes	Values	Values	Values	Values	Values
21-24	1-4	0.23	0.5	0.23	0.23	0.23
132-135	5-8	0.23	0.5	0.23	0.23	0.23
25-28	1-4	12.0	9.0	12.0	12.0	14.5
236-239	5-8	12.0	9.0	12.0	12.0	14.5
20	N/A	72	72	72	72	72
29	N/A	150	150	150	150	150
30	N/A	180	180	180	180	180

Suggested values for DC Brush Motors and Drives						
Servo Drive		9A Drive, 17 in/lb motors	12A Drive, 29 in/lb motors	15A Drive, 29 in/lb motors	15A Drive, 40 in/lb motors	25A Drive, 40 in/lb motors
Parameters	Axes	Values	Values	Values	Values	Values
21-24	1-4	0.028	0.02	0.027	0.03	0.04
132-135	5-8	0.028	0.02	0.027	0.03	0.04
25-28	1-4	0.68	0.68	0.68	0.68	0.68
236-239	5-8	0.68	0.68	0.68	0.68	0.68
20	N/A	72	72	72	72	72
29	N/A	150	150	150	150	150
30	N/A	180	180	180	180	180

Parameter 31 - Legacy SPIN232 Com Port

For values 1-255, CNC11 will attempt to open that COM port and send out spindle commands. CNC11 should be restarted after changing this value from 0 (disabled) to a valid value. Note that the baud rate is assumed to be 19200 to work specifically with a SPIN232.

Parameter 33 - Spindle Motor Gear Ratio

NOTICE The default value for this parameter is 1 and should not be changed unless you have consulted your dealer or local Technical representative!!!

Parameter 33 is used for the gear or belt ratio between the spindle motor and the chuck in high gear range. It should be greater than 1.0 if the motor turns faster than the chuck and less than 1.0 if the chuck turns faster than the motor. Note: this value applies to high range. The ratio between high range and lower ranges is established by the gear ratio parameters (65-67).

Parameter 34 - Spindle Encoder Counts/Rev

This parameter controls the counts/revolution for the spindle encoder. Input from the spindle encoder is required for the spindle-slaved movements used in the Rigid Tapping cycles. If the encoder counts up when running CW (M3), the value of this parameter must be positive. If the encoder counts up when running CCW (M4), the value of this parameter must be negative.

Parameter 35 – Spindle Encoder Axis Number

Input from a spindle encoder is required for spindle-slaved movements such as those used in the Rigid Tapping cycles. If there is no spindle encoder connected, then this parameter should be set to 0. This parameter specifies the axis number (1 through 8) to which the spindle encoder is assigned. Encoder assignments are specified by parameters 308-315. For example, if you decide to configure the 5th axis as the spindle, and the spindle's encoder is the 1st MPU11 onboard input encoder, then Parameter 35 (this parameter) should be set to 5, and Parameter 312 should be set to 1.

Parameter 36 - Rigid Tapping Enable/Disable

This parameter is a bit field that enables or disables Rigid Tapping and its options.

Bit	Function Description	Parameter Value
0	Enable Rigid Tapping?	Yes = 1, No = 0
1	Suppress sending "Wait for Index Pulse" during Rigid Tapping?	Yes = 2, No = 0
2	Allow Spindle Override during Rigid Tapping?	Yes = 4, No = 0
3	Use Spindle Off system variable bit? (see note below)	Yes = 8, No = 0 (see note below)
4	What is the Spindle Encoder measuring? I.e. What is the physical mounting location of Spindle Encoder? (see note below)	Spindle Encoder measures rotation of spindle drive motor: value = 16, Spindle Encoder measures rotation of spindle head: value = 0 (see note below)

Note on Bit 3: This bit enables the spindle off system variable, for mpu11 systems. Most systems will not need to set this bit. Mpu11 systems will not execute custom M5 macro commands during a rigid tap. Instead the software determines which bit, M3 or M4, to turn off to stop the spindle. Alternatively, setting bit 3 will cause the software to set the spindle off system variable bit, SV_PC_RIGID_TAP_SPINDLE_OFF. The plc program is then responsible for monitoring that bit and performing all actions in order to turn off the spindle.

Note on Bit 4: On machines where the Spindle Encoder is set up to measure the spindle drive motor rotation (Bit 4 = on, value 16), multi-pass Rigid Tapping and repeated Rigid Tapping down the same hole can only be done in the High Spindle Range. (See Parameters 33 and 65-67 for description of Spindle Gear ranges/ratios.)

Parameter 37 - Spindle Deceleration Time (Rigid Tapping Parameter)

This parameter is used in conjunction with parameter 36 when rigid tapping is enabled. This sets the amount of time required for the spindle to decelerate before it switches direction during a rigid tapping operation.

Parameter 38 - Multi-Axis Max Feedrate

This parameter is used to limit the feedrate along all commanded move vectors. This parameter can be used to limit the speed of multi-axis moves on machines that may have enough power to move a single axis rapidly, but starve out of power on 2 or 3 axis rapid moves. A zero in this parameter will disable this feature. Note that this feature has no effect for movement commands handled by Smoothing (P220=1).

Parameter 39 - Feedrate Override Percentage Limit

This parameter is used for limiting the upper end of the Feedrate Override Knob percentage to a value from 100% to 200%. This parameter can be used to restrict the Feedrate Override Knob effect on machines with maximum rates over 200 in/min. The Feedrate Override Knob percentage is normally allowed to go to 200%. However, on machines with high cutting speeds, if the knob is turned up to 200%, it creates overshoots on corners. If this parameter is set to something like 110, it will stop the Feedrate Override Knob from exceeding 110% and thus causes the overshoots to disappear. The PLC program must check this parameter to actually enforce the limiting of Feedrate Override.

Parameter 40 - Basic Jog Increment

This parameter holds the basic jog increment for linear axes (0.0001" or 0.002 mm by default). This value works in conjunction with the x1, x10, and x100 jog keys to determine the amount to move a linear axis during incremental jogging.

Parameter 41 – Rotary Axis Jog Increment

This parameter holds the jog increment for rotary axes (0.01° by default). This value works in conjunction with the x1, x10, and x100 jog keys to determine the amount to move a rotary axis during incremental jogging.

Parameter 42 – Password for Configuration Menus

This parameter determines the password that the user must enter in order to gain full access to the configuration menus.

Value	Meaning
54.0	No password required for supervisor access; the user is not prompted for a password
ABCD.ABCD	Password is 4 digits represented by "ABCD" Example: for the password to be 1234, set to 1234.1234
Any other number	Password is "137"

Parameter 43 – Automatic tool measurement options

This parameter is a bit field that is used to configure properties of the TT1.

Bit	Function	Parameter Value
0	The height of the tool detector (parameter 71) will be subtracted from the measured height of the tool.	Yes = 1; No = 0
1	Which PLC input to use for the Tool Z reference measurement. 0 = Use Touch Probe input in Parameter 11. 2 = Use TT1 input in Parameter 44.	0 = Use Parameter 11. 2 = Use Parameter 44.
2	Remind the operator to plug in the TT1 before doing Batch Tool Measuring.	Yes = 4; No = 0

Parameter 44 – TT1 PLC input number

This parameter is the input number that the TT1 is wired into on the PLC. If a shared PLC input is used for the TT1 and the DP4 probe, then the value can be left at zero or set to the same value as parameter #11.

NOTICE If you are using a different PLC input for the TT1 and DP4 when setting the Z reference in the tool library with the DP4, make sure you don't use a ruby probe tip. The TT1 is electrical continuity based and the ruby tip is not electrically conductive!

Parameter 48 – Grid Digitize Patch Playback Z rapid clearance amount

This is the additional Z clearance amount higher than the Z surface level at which the original Grid Digitizing operation was begun. The purpose of this value is to set the recorded starting “rapid to” Z level of a Grid Digitize playback patch. In other words, the Z starting point of the first feedrate plunge move of the recorded patch is equal to the Z coordinate of the start of the original Grid Digitizing operation plus the value of this parameter.

Parameters 49-51 – Small Arc Feedrate Limiting

These parameters are intended to control the feedrate limits of small-radius arc moves.

Parameter	Function Description	Input format
49	Lower arc radius/feedrate limiting parameter	rrrr.ffff , where rrrr is a radius threshold setting, and .ffff is a feedrate adjustment setting
50	Upper arc radius/feedrate limiting parameter	RRRR.FFFF , where RRRR is a radius threshold setting, and .FFFF is a feedrate adjustment setting
51	Arc Feedrate Limiting mode	2 digit positive number. 1's digit (right digit) = Lower Limiting mode 10's digit (left digit) = Upper Limiting mode

The 2 digits in Parameter 51 can have the following values and associated meaning:

- 0 - Turn off Arc feedrate limiting for the associated radii range (default value)
- 1 - Literal Mode Feedrate limit = FFFF (.FFFF x 10000) for the associated radii range.
- 2 - Fractional Mode Feedrate limit = .FFFF x Programmed feedrate for the associated radii range
- 3 - Proportional Mode Feedrate limit = Arc radius x .FFFF x Programmed feedrate for the associated radii range

The Lower Arc Limiting mode's radii range includes any arc radius from 0 up to and including the rrrr setting of Parameter 49. So, if you program a G2 or G3 arc with a radius of rrrr (of Parameter 49) or less, and the Lower Limiting mode in Parameter 51 is turned on, then the arc's feedrate will be limited according to how ffff (of Parameter 49) is interpreted. If the Control is set up in Millimeter mode, then rrrr specifies the number of millimeters. However, if the Control is set up in Inch mode, then rrrr means the number of inches divided by 100.

The Upper Arc Limiting mode's radii range includes any arc radius larger than the rrrr setting of Parameter 49 up to and including the RRRR setting of Parameter 50. So, if you program a G2 or G3 arc with a radius of RRRR (of Parameter 50) or less, but greater than rrrr (of Parameter 49), and the Upper Limiting mode in Parameter 51 is turned on, then the arc's feedrate will be limited according to how FFFF (of Parameter 50) is interpreted. If the Control is set up in Millimeter mode, then rrrr specifies the number of millimeters. However, if the Control is set up in Inch mode, then rrrr means the number of inches divided by 100.

Note that if Parameter 51 contains values other than 00, 01, 02, 03, 10, 11, 12, 13, 20, 21, 22, 23, 30, 31, 32, 33, it will be treated as invalid and will cause the Small Arc Feedrate Limiting feature to be disabled.

Also note that this feature has no effect for arc movement handled by Smoothing (P220=1).

Examples (in millimeters):

Parameter 49 = 5.0050 (rrrr = 5 mm, ffff = 0050)

Parameter 50 = 75.1500 (RRRR = 75 mm, FFFF = 1500)

If Parameter 51 = 31 and you program a G2 arc with a radius of 4 mm at a feedrate of 1000 mm/min, then the actual feedrate of the arc will be lowered down to 50 mm/min.

If Parameter 51 = 23 and you program a G3 arc with a radius of 40 mm at a feedrate of 700 mm/min, then the actual feedrate of the arc will be lowered down to 105 mm/min (=700 x .1500).

If Parameter 51 = 33 and you program a G3 arc with a radius of 72 mm at a feedrate of 1200 mm/min, then the actual feedrate of the arc will remain at 1200 mm/min and will not be modified because it is well within the Feedrate limit of 12960 mm/min (Arc radius x .FFFF x Programmed feedrate = 72 x .1500 x 1200 = 12960).

If Parameter 51 = 11 and you program a G2 arc with a radius of 100 mm at a feedrate of 2500 mm/min, then the actual feedrate of the arc will remain unmodified at 2500 mm/min because the arc radius is outside both ranges specified by Parameters 49 and 50, and therefore this feature does not affect such arcs.

Examples (in inches):

Parameter 49 = 50.0050 (rrrr = ½ inch, ffff = 0010)

Parameter 50 = 200.1500 (RRRR = 2 inches, FFFF = 1500)

If Parameter 51 = 31 and you program a G2 arc with a radius of ¼ inch at a feedrate of 100 inches/min, then the actual feedrate of the arc will be lowered down to 10 inches per minute.

If Parameter 51 = 23 and you program a G3 arc with a radius of 1.5 inches at a feedrate of 200 inches/min, then the actual feedrate of the arc will be lowered down to 30 inches/min (=200 x .1500).

If Parameter 51 = 33 and you program a G3 arc with a radius of 1.75 inches at a feedrate of 300 inches/min, then the actual feedrate of the arc will be lowered down to 78.75 inches/min (= Arc radius x .FFFF x Programmed feerate = 1.75 x .1500 x 300).

If Parameter 51 = 11 and you program a G2 arc with a radius of 3 inches at a feedrate of 250 inches/min, then the actual feedrate of the arc will remain unmodified at 250 inches/min because the arc radius is outside both ranges specified by Parameters 49 and 50, and therefore this feature does not affect such arcs.

Parameter 56 – Feedrate Override Display Properties / Inverse Time interpretation

Bits 1 and 2 define how the federate override is displayed in the status window. Bit 3 selects the meaning of inverse time feedrates (F) when inverse time mode (G93) is active. Bit 0 is unused.

Bit	Function	Parameter Value
0	Not used	
1	Display programmed rate not actual	2 = Yes; 0 = No
2	Display a bar meter of percentage	4 = Yes; 0 = No
3	Inverse time meaning of F	8 = F is in inverse seconds, 0 = F is in inverse minutes

Parameters 61-62 - Stall Detection Parameters

The M-Series control will detect and report several stall conditions. The low power stall occurs if the control has been applying a specified minimum current for a specified time, and no encoder motion has been detected. This may indicate a loose or severed encoder cable. A high power stall occurs if the control has been applying at least 90% current for a specified time, and no motion greater than 0.0005" has been detected. This may indicate a physical obstruction. Note that this feature will only work with torque mode drives and not velocity mode drives.

Parameter 61 is the time limit, in seconds, for a high power stall. The default is 0.5 seconds.

Parameter 62 is the PID output threshold for a high power stall. The default is 115.

Parameter 63 - High Power Idle PID Multiplier

This parameter holds the value of a constant used for motor temperature estimation when an axis is not moving and no job is running, but there is power going into the motor to maintain its position. The default value is 1.5. This temperature estimation is intended for early detection of an axis if it's stopped against some abnormal resistance, such that it will probably overheat later.

Parameter 64 – Fourth/Fifth Axis Pairing

This feature enables the 4th and 5th axes to be paired together or individually be run in a slaved state with any of the other axes. This is intended to drive 2 screws on opposite sides of a table (probably a router table or gantry system). Set this parameter to 0 (default) to indicate that no other axis is paired with the 4th or 5th axis. In order to pair both the 4th and 5th axes on the same system add the 4th axis value with the 5th axis value. Example: 4th axis paired with the X-axis and 5th axis paired with the Z-axis a value of 49 would be entered into parameter 64. The axes are slaved upon power up but it is still possible to move the paired (4th or 5th) axis independently if the axis is labeled.

* NOTE: You cannot run Autotune on paired axes.

Value	Meaning
0	No Pairing (Default)
1	Pair 4 th axis with 1 st Axis
2	Pair 4 th axis with 2 nd Axis
3	Pair 4 th axis with 3 rd Axis
16	Pair 5 th axis with 1 st Axis
32	Pair 5 th axis with 2 nd Axis
48	Pair 5 th axis with 3 rd Axis
64	Pair 5 th axis with 4 th Axis

Parameters 65-67 - Spindle Gear Ratios

These parameters tell the control the gear ratios for a multi-range spindle drive. Up to four speed ranges are supported; high range is the default. Parameters 65-67 specify the gear ratio for each lower range, relative to high range. For example, if the machine is a mill with a dual range spindle, and the spindle in low range turns 1/10 the speed it turns in high range, then parameter 65 should be set to 0.1. Note that these values can be signed +/- . So, if switching from high range to a lower range causes the spindle encoder to count in the opposite direction, then a negative value can be used to compensate for this behavior.

Parameter 65 is the low range gear ratio.

Parameter 66 is the medium-low range gear ratio.

Parameter 67 is the medium-high range gear ratio.

These parameters work in conjunction with the PLC program, which uses the states of INP63 and INP64 to signal to the CNC software which range is in effect, according to the table below.

PLC INPUT	Spindle Range			
	High Range	Medium High Range	Medium Low Range	Low Range
INP63	0	1	1	0
INP64	0	0	1	1

Parameter 68 – Minimum Spindle Speed (Rigid Tapping Parameter)

This parameter holds the value that the spindle slows down to from the programmed spindle speed towards the end of the tapping cycle. The lower the value, the more accurately the Z-axis will land on target, but at the expense of possibly stalling the spindle motor which in turn will cause Z-axis to fall short. If this value is too large, the off target error will increase. The suggested starting value is 640 RPM.

Parameter 69 – Duration for Minimum Spindle Speed Mode (Rigid Tapping Parameter)

This is the duration of time, in seconds, that the control will stay at minimum spindle speed. If the number is too small, overshoot will occur. If the number is too large, the user waits longer for the hole to be tapped at the slow speed specified by parameter 68. The suggested starting value is 1.25 seconds.

Parameter 70 - Offset Library Inc/Decrement Amount

Sets the increment and decrement amount used in the offset library.

Parameter 71 – Part Setup Detector Height

If this Parameter is set to a non-zero value, it indicates that the **F3 - Auto** feature in part setup should be available using the tool detector (TT1) instead of the probe. The value in this parameter is the height of the detector. A value of 0 disables this feature.

When this feature is enabled:

- Probe detection (Parameter 18) is not checked
- The tool number and/or edge finder diameter entered by the operator are used; Parameter 12 is ignored.
- The value from Parameter 71 is added to (or subtracted from, depending on approach direction) the part position.

Parameter 72 – Data M Function Options

The setting of this parameter affects the operation of the data M functions M122, M123, and M124.

Bit	Function Description	Parameter Value
0	Suppress output of axis labels by M122/M124?	Yes = 1, No = 0
1	Insert commas between positions/values with M122/M124?	Yes = 2, No = 0
2	Suppress spaces between positions/values outputted by M122/M123/M124?	Yes = 4, No = 0

Parameter 73 – Peck Drill Retract Amount (Canned Cycle Parameter)

This specifies the retract amount used during a G73 peck drilling cycle.

Parameter 74 – M-function executed at bottom of tapping cycle (Canned Cycle Parameter)

This specifies the number of the M-function that is executed at the bottom of the G84 tapping cycle (primarily used for reversing the spindle in preparation for pulling out of the tap hole). This also specifies the number of the M-function that is executed after the G74 countertapping cycle is done (returned to the initial point).

Parameter 75 – Summing Control

This parameter controls the type of position to be summed (local or machine), and which axes are to be summed together and which axis will bear the effects of the the summing. The parameter can contain up to four digits. The sign of the parameter value and the position and value of each digit has special significance as indicated in the tables below:

Sign	Position Type
+	Sum Machine Coordinates
-	Sum Local Coordinates

Parameter Digit Position	Summed Axis
1's Column	Axis 1
10's Column	Axis 2
100's Column	Axis 3
1,000's Column	Axis 4

Digit Value	Meaning
0	Summing off
1 through 4	Axis to Sum with
5	(Reserved)
6	Disable display
7	Display if moved
8	Display if other moves
9	(Reserved)

The “**Summed Axis**” is the axis that bears the position sum of itself with the “**Axis to Sum with**”. The DRO display of the “**Summed Axis**” will show this summed position. The DRO will display both labels when displaying a summed axis. Furthermore, G-codes that command movement on the “**Summed Axis**” will have their positions offset by the position of the “**Axis to Sum with**”.

NOTICE It is highly recommended that summing be done with Local Coordinates (using the ‘-’ sign in the parameter value). Summing with Machine Coordinates can cause the effective software travel limits to move, thus resulting in physical overtravel or severely handicapping the amount of available travel, due to the fact that software travel limits are defined in terms of Machine Coordinates. Summing with Local Coordinates avoids this problem.

Here are some examples:

Desired Display	Parameter
Axis 3 DRO will display the result of axis 3 and 4 machine coordinate positions summed together.	400
Axis 4 DRO will display the result of axis 4 and 3 local coordinate positions summed together. Machine coordinate positions are not affected.	-3000
Axis 3 DRO will display the result of axis 3 and 4 local coordinate positions summed together. Axis 4 DRO display will be disabled.	-6400
Axis 4 DRO will display the result of axis 4 and 3 local coordinate positions summed together. Axis 3 DRO display will be disabled.	-3600
Axis 3 DRO will display the result of axis 3 and 4 local coordinate positions summed together. Axis 4 will be displayed only if it moves.	-7400

Parameter 76 – Manual Input Unrestricted Distance

This parameter is intended to be used with Z-axis summing. It defines the maximum distance from the summed axis start of travel in which manual movements can occur without causing a fault. Use a negative value to specify a distance from the minus travel limit, a positive value for a distance from the plus travel limit.

When used with manual drilling, for example, setting this parameter will allow the operator to keep a hand on the quill at all times and even begin pulling on the quill in anticipation of a programmed stop.

Setting this value to zero will cause a fault if there is any manual movement.

To completely disable manual movement restrictions, set this parameter to a value exceeding the total travel of the summed axis.

Minimum = -99999.9999, maximum = 9999.9999, default = 0, typical = +/- 1.0 inch or +/- 20.0 mm

Parameter 77 – Manual Input Movement Tolerance

This parameter specifies the manual movement tolerance while a job is running. It is intended for use with a quill locking mechanism. It allows the lock to distort and/or slip a small amount when under stress. If the quill moves more than the given tolerance, the job will stop with a fault. A typical setting for Parameter 77 is 0.005 inches.

Parameter 78 – Spindle Speed Display and Operations

Bit 0 (value = 1) specifies how the spindle speed is determined and displayed in the CNC software status window. When turned on (value = 1), the spindle speed is determined by reading the encoder feedback from the axis specified according to parameter 35. Which has the number of encoder counts/revolution specified in parameter 34. When turned off (value = 0), the displayed speed is not measured; the speed is calculated based upon the programmed speed, spindle override adjustment, and gear range.

Bit 1 (value = 2) allows the control to prorate the programmed feedrate to be proportional to the spindle speed if the spindle speed ever slows down below the spindle speed threshold percent as set by parameter 149.

Bit 2 (value = 4) will turn on the “Spindle up-to-speed” function. The active modal spindle speed S at the point where the most recent M3 or M4 is invoked sets the target spindle speed for this function. This function is invoked on the first feed-per-minute move (such as G1/G2/G3) following the aforementioned M3 or M4. If the actual measured spindle speed at this moment is below the spindle speed threshold percent (parameter 149) of target spindle speed, this function will pause the job at this point until the spindle speed gets up to at least this spindle speed threshold percent level.

Bit	Function	Value
0	Display actual spindle speed	Yes = 1, No = 0
1	Slave feedrate to spindle speed	Yes = 2, No = 0
2	Wait for spindle to get up to speed on feed-per-minute moves	Yes = 4, No = 0

Parameter 80 – Voltage Brake Message Frequency

This parameter specifies the number of times the “450 Voltage brake applied” message has to occur before we show it in the message window and message log. A value of 0 or 1 will display the message for every instance that it occurs.

Parameter 81 – Air Drill M-function (Canned Cycle Parameter)

P81 (when not equal to –1.0) specifies the M-function to be called in place of Z-axis movement during a G81 drilling cycle.

Parameter 82 – Spindle Drift Adjustment (Rigid Tapping Parameter)

This value is the number of degrees that the spindle will take to coast to a stop, when the spindle is turned off at the minimum spindle speed specified by parameter 68.

Parameter 83 – Deep Hole clearance amount (Canned Cycle Parameter)

Parameter 83 specifies the clearance amount used during a G83 deep hole drilling cycle.

Parameter 84 – M function executed at return to initial point of tapping cycle (Canned Cycle Parameter)

This specifies the number of the M-function that is executed after the G84 tapping cycle is done (returned to the initial point). This also specifies the number of the M-function that is executed at the bottom of the G74 countertapping cycle (to reverse the spindle in preparation for pulling out of the countertap hole).

Parameter 85 – “Door Open” Interlock PLC bit

This parameter provides a way for a system integrator to implement a safety interlock that limits rate of movement when the doors are open. This parameter specifies the PLC bit number and PLC bit polarity that indicates the “door open” condition. If the specified PLC bit is in the specified “door open” condition, then all normal movement commands (G0, G1, G2, G3) will be limited to the slow jog rate (as specified in the Jog Parameters menu in Machine Configuration). Polarity of the “door open” condition is specified thuswise: a positive number indicates that the “door open” condition occurs when the specified PLC bit is On, and a negative number indicates that the “door open” condition occurs when the specified PLC bit is Off. If this parameter is set to 0 (the default value), then this feature is disabled, and no checking for a “door open” condition is done. Note that this feature has no effect for movement commands handled by Smoothing (P220=1). Also note that PLC program interaction is needed for this feature to work.

Parameter 86 – Rapid/Linear vector rate limit

This parameter controls the feature that imposes a limit on the number of rapid and/or linear moves per second to the value specified in this parameter. If the value of this parameter is more than 0, Rapid and/or Linear moves will be combined to prevent the aforementioned limit from being exceeded. This parameter is used for testing purposes and should be set to 0 to disable this feature. Note that this feature has no effect for movement commands handled by Smoothing (P220=1).

Parameters 87-90 (and also 252-255) - Autotune Ka Performance parameters

These parameters are used by autotune. Increasing the value will increase the Ka used by autotune which when used will increase the PID used during acceleration. The default value is 0. The maximum value is 50 and the minimum value is 0. Values for axes 1-4 are specified in parameters 87-90. Values for axes 5-8 are specified in parameters 252-255.

Parameters 91-94 (and also 166-169) – Axis Properties

These parameters may be used to set various axis properties. Properties for axes 1-4 are specified in parameters 91-94. Properties for axes 5-8 are specified in parameters 166-169.

Bit	Function Description	Parameter Value
0	Rotary/Linear Axis Selection	Rotary Axis = 1, Linear Axis = 0
1	Rotary Display Mode	Wrap Around = 2, Show Rotations = 0
2	Suppress direction check when doing Tool Check?	Don't Check = 4, Check = 0
3	Suppress park function?	Don't Park = 8, Park = 0
4	NOT USED ON MILL	Recommended bit value is 0
5	Linear Display of Rotary Axis	Linear Display = 32, Default Rotary = 0
6	4 th Axis works like Z axis	Yes = 64, No = 0
7	NOT USED ON MILL	Recommended bit value is 0
8	Axis is triangular rotary?	Yes = 256, No = 0
9	Hide axis display from DRO	Yes = 512, No = 0
10	Triangular rotary axis type	Articulated Head = 1024, Tilt Table = 0
11	Rotation Center is parallel to X?	Yes = 2048, No = 0
12	NOT USED	Recommended bit value is 0
13	NOT USED	Recommended bit value is 0
14	Enable TWCS for Articulated Head machines	Yes = 16384, No = 0

Bit 0: Turning this bit on will cause the DRO display for the affected axis to be displayed in degrees. Also this information is used by Intercon to make rotary axis support available (by setting parameter 94 to 1, indicating that the fourth axis is rotary). This bit is also used when performing inch/mm conversions: values for a rotary axis will not be converted since they are assumed to be in degrees regardless of the system of linear units.

Bit 1: This bit has no effect unless Bit 0 (mentioned above) is turned on. When this bit is turned on, a “Wrap Around” display is shown on the DRO. A “Wrap Around” Rotary Display is a display in degrees without the number of rotations shown. If this bit is turned off, the number of rotations away from 0 degrees will be shown alongside the degree display.

Bit 2: This bit will only affect the Z-axis. It controls whether or not a direction check will be performed when the Tool Check button is pressed. If this bit is turned on, direction checking is turned off, and thus, there is a possibility for the Z-axis to move downward unexpectedly, depending on the Z value of Return Point #1 (G28). Therefore, it is best in most cases to leave this bit turned off to allow direction checking to be turned on (value = 0).

Bit 3: Setting this bit prevents <F1> (Park) in the Shutdown menu from parking this axis.

Bit 5: This setting overrides only the DRO display options for an axis that has bit 0 set (including the Rotary Display Mode – bit 1) so that the display does not reflect a degree symbol or any indication of the number of rotations, but appears as a linear axis.

Bit 6: This bit only works for Parameter 94 (4th axis). Setting this bit will cause the 4th axis to respond to Z-axis only commands just like the Z-axis, for example issuing an M25 with this bit set will cause the Z and 4th axes to go the home (G28) position.

Bit 8: This setting is used in conjunction with bit 10. It only works for parameter 166 (5th axis). Setting this bit on will identify this axis as a Triangular Rotary, which may either be an Articulated Head axis, or a Tilt Table axis.

Bit 9: This setting will hide the affected axis from the DRO display. Note that this does not prevent such an axis from being commanded to move.

Bit 10: In order for this setting to work, bit 8 must be turned on. This setting has meaning only for parameter 166 (5th axis). Setting this bit on will identify this axis as the controller of the angle of articulation on an Articulated Head machine. If this bit is not set, then this axis will be identified as the controller of the tilt angle on a Tilt Table machine.

Bit 11: In order for this setting to work, bit 0 must be turned on (i.e. axis is rotary). Also, this setting only affects axes 4 and higher. This setting indicates that this rotary axis is mounted in such a way so that its rotation center line is parallel to the X axis (axis 1). The rotation center line's machine coordinate location is then defined by parameters 116 and 117. This setting enables backplot to display rotary movements encircling the X axis and also gives the needed machine geometry information to G93.1 for it to properly calculate the tool tip feedrate in 3D space in such a configuration.

Bit 14: This bit (in conjunction with the CSR unlock) enables the TWCS (Transformed WCS) feature for Articulated Head machines. When this feature is enabled, each individual WCS can be independently set up as either transformed or non-transformed using the TWCS=Yes/No setting in the WCS configuration screen (See TWCS in Chapter 4). However, enabling this feature bit will always cause automatic B/5th axis transformation on certain features regardless of the TWCS=Yes/No setting for each WCS. Such features are: Tool Check, M25, Digitizing, and the movements done in the Probing Cycles.

Parameters 95-98 (and also 156-159) - Autotune Move Distance / Auto Delay Calculation Move Distance

These parameters hold the maximum distance that the control will move each axis in either direction from the starting point when either Autotune or Auto Delay Calculation is run. The default value for these parameters is 2.0 inches. Values for axes 1-4 are specified in parameters 95-98. Values for axes 5-8 are specified in parameters 156-159.

Parameter 99 – Cutter Compensation Look-ahead

This parameter sets the default number of line or arc events for the G-code interpreter to scan ahead when Cutter Compensation (G41 or G42) is active. Values of 1 to 99 are allowed for this parameter and default is 1.

Parameters 100–106 and 115 - Intercon parameters

These parameters are some of the Intercon setup parameters. See Chapter 10 for more information about these parameters. Changing values will change Intercon settings and may affect the output of the G-code program if it is re-posted.

Parameter 116 – A-Axis Y Coordinate

This parameter is used in conjunction with Dig to CAD to export digitized data for use with CAD/CAM software (see Chapter 8). It is used to define the Y coordinate of the center of rotation for a rotary axis that rotates about the X-axis.

Parameter 117– A-Axis Z Coordinate

This parameter is used in conjunction with Dig to CAD to export digitized data for use with CAD/CAM software (see Chapter 8). It is used to define the Z coordinate of the center of rotation for a rotary axis that rotates about the X-axis.

Parameter 118 – B-Axis X Coordinate

This parameter is used in conjunction with Dig to CAD to export digitized data for use with CAD/CAM software (see Chapter 8). It is used to define the X coordinate of the center of rotation for a rotary axis that rotates about the Y-axis.

Parameter 119 – B-Axis Z Coordinate

This parameter is used in conjunction with Dig to CAD to export digitized data for use with CAD/CAM software (see Chapter 8). It is used to define the Z coordinate of the center of rotation for a rotary axis that rotates about the Y-axis.

Parameter 120 – Probe Stuck Clearance Amount

This parameter specifies the distance that digitizing or probing functions will move to try to clear a stuck probe condition. A stuck probe condition exists when the probe detects a point and then moves away but the probe input has not changed. It is recommended that this parameter should not be changed from its default value without consulting a qualified technician.

Parameter 121 – Grid digitize prediction minimum Z pullback

This parameter specifies the minimum distance the Z-axis will move upward when pulling back from a surface. The digitizing function attempts to predict the slope of a part surface because time is saved when the Z-axis does not have to travel upward to the starting Z depth for every digitized point. When probe contact is made traversing in the XY plane, this parameter specifies the minimum distance the Z-axis moves upward before attempting another XY plane move. Smaller values are better when the surface being digitized has smooth curves. Larger values are better for surfaces that have steep walls. It is recommended that this parameter should not be changed from its default value without consulting a qualified technician.

Parameter 122 – Grid digitizing deadband move distance

This parameter specifies a deadband distance used for internal calculations when doing a clearance move. It is recommended that this parameter should not be changed from its default value.

Parameter 123 – Radial Clearance Move

This parameter only applies to radial digitizing and determines what type of positioning move the digitizing probe will make should it encounter an unexpected probe contact with the surface of the part during Radial Digitizing.

Unexpected probe contact is defined as probe contact occurring while the probe is traversing towards the user defined center point.

With Parameter 123 set to 0: When the probe encounters an unexpected probe contact, the digitizing program stops data collection. The control then prompts the operator to jog the probe to a clear position. This can be any place inside the digitizing radius and above the part, that the probe stylus has a clear path to the defined center position. To restart data collection press **Cycle Start**. The probe moves in the XY plane from the position the operator placed it at, to the center position defined in the radial setup menu. After reaching the center position, the probe will feed down to the Z-axis position it was at when the data collection was interrupted. The digitizing run will resume with the probe approaching from the defined center position.

With Parameter 123 set to 1: When the probe encounters an unexpected probe contact, it will automatically move (with probe detection turned off) to the maximum Z height, then moves the X and Y-axis to the defined center position. The probe will then move to the Z position it was at when the unexpected contact occurred. It will then move from the defined center position, towards the measurement position it was trying to approach when the unexpected probe contact occurred and continue digitizing.

With Parameter 123 set to 2: When the probe encounters an unexpected probe contact, it will automatically move back to the defined center position (with probe detection turned off), at its present Z height. It will then move from the defined center position, towards the measurement position it was trying to approach when the unexpected probe contact occurred and continue digitizing.

NOTICE Settings 1 and 2 should only be used with extreme caution because probe detection during some positioning moves is turned off, and damage to the probe or work piece could occur!

Parameter 130, 131 – 3rd/ 4th axis on/off selection

These parameters control the display of the 3rd and 4th axes, respectively. The tens digit of the parameter value specifies the label of the affected axis when it is enabled, with values 1-9 corresponding to axis labels ABCUVWXYZ. The ones digit specifies the label of the axis when it is disabled, with 0.0 meaning the axis is not switchable, 1.0 meaning it turns off (N), a 2.0 meaning manual (M), and a 3.0 meaning 2-axis with manual Z (@). Parameter 130 also supports additional modes depending upon the value of the hundreds digit. See the chart below for valid values for the Hundred's digit of Parameter 130. Note that Parameter 131 does not support the Hundred's digit. When P130/P131 is configured for axis switching, the Setup menu displays function keys **F5/F6** to switch the axes.

Example 1:

A value of 192 in parameter 130 will toggle the 3rd axis between Z and M and power off all axes. The 1 sets bit one to power all axes off, the 9 enables the 3rd axis to “Z”, and the 2 changes the axis label to “M” once toggled with the F5 key in the Setup menu.

Example 2:

A value of 392 in parameter 130 will toggle the 3rd axis label between Z and M and power off all axes and receive its positions from the 4th axis encoder input. The 3 sets bits two and one to power off all axes and use the 4th encoder input as a scale input, the 9 enables the 3rd axis to “Z”, and the 2 changes the axis label to “M” once toggled with the F5 key in the Setup menu.

Example 3:

A value of 61 in parameter 131 will toggle the 4th axis between W and N. The 6 enables the 4th axis to “W” and the 2 changes the axis label to “N” when toggled with the F6 key in the Setup menu. This will turn the 4th axis on and off.

Hundred's Digit (Parameter 130 only)	Function Description	Value of the Hundred's Digit
Bit1	Axis motor power when switching to two-axis mode.	1 = power all axes off, 0 = power 3rd off only
Bit2	Use 4 th encoder input for scale input	2 = Use 4 th encoder input, 0 = no manual input
Bit3	Use 5 th encoder input for scale input	4 = Use 5 th encoder input, 0 = no manual input

Enabled Axis:	A	B	C	U	V	W	X	Y	Z
Ten's Digit	1	2	3	4	4	6	7	8	9

Disabled Axis:	N	M	@
One's Digit	1	2	3

Parameters 132-135 – Motor Heating Coefficients for axes 5-8

See parameters 20-30 for more information.

Parameter 139 – Special Dwell between Moves

This parameter turns on and specifies the amount dwell time between moves, with exceptions in special cases. This parameter is similar to specifying a G61 (Modal Decel and Stop) at the beginning of a CNC program, except that dwelling will not happen under certain conditions: (1) No dwell will happen between 2 arcs. (2) No dwell will happen if before the move that contains Z movement.

Parameter 140 – Message log priority level

This parameter controls the messages that are written to the message log, which can be accessed through the **F9 - Logs** function in the Utilities menu. See Chapter 15 for the list of numbered messages. Message logging can be disabled by setting this parameter to -1. The recommended log level is 4.

Value	Which numbered messages are logged
-1	None
1	Numbered messages 0-299 and 400-499 – The most serious faults.
4	Numbered messages 0-299 and 400 and higher – The most serious faults and medium severity errors.
9	All numbered messages

Parameter 141 – Maximum message log lines

This parameter is the number of lines that will be kept in the message log. If this parameter is set to 10,000, for example, the newest 10,000 messages will be retained. The CNC software will delete the oldest messages, trimming the log file to the given number of lines at startup and periodically while the CNC software is in an idle state. Parameter 142 controls the frequency of the log cleanup.

Parameter 142 – Message log trim amount

This parameter is the number of additional lines above the minimum that can be added to the log before it is reduced to the minimum size. Setting this parameter to a lower value will cause the log file to be trimmed to its minimum size more often. The higher the value, the less often the log will be trimmed. The speed of the disk drive and total size of the log file at the time it is trimmed will determine how long the log cleanup takes. Under most circumstances, using 10,000 and 1,000 for parameters 141 and 142 will provide a reasonable and useful log size with no noticeable effects on performance. If parameters 141 and 142 are set to excessively high values, the message "Trimming excess lines from log file" will be presented. This message will appear at startup and very infrequently when the CNC software is idle. Normal operation can proceed after the message disappears. If the delay is unacceptable, reduce the values of parameters 141 and 142.

Parameter 143 – DRO Properties (load meters, 4/5 digits, Distance To Go)

This parameter controls the display of the axis load meters and 4/5 digit DRO precision.

Bit	Function Description	Parameter Value
0	Enable Load Meters	Enable = 1, Disable = 0
1	Load Meter Outline	Enable = 2, Disable = 0
2	DRO 4/5 Digit Precision	5 digits = 4, 4 digits = 0
3	Mini DRO (Distance to Go)	Enable = 8, Disable = 0

Add the values of the desired properties. For example, use a value of 3 to display load meters with outlines. The value 11 will display load meters, outlines and the mini-DRO. The axis load meters will be colored green for values that are up to 70% of maximum power output, yellow for values between 70% and 90%, and red for values between 90% and 100%. The axis load meters appear below the DRO for each axis (see Chapter 1).

Parameter 144 – Comparison Rounding

This parameter determines the built in rounding for the comparison operators ('EQ', 'NE', 'LT', 'GT', etc.) in expressions. Rounding of comparison arguments is necessary due to extremely small errors that are part of every floating-point calculation. The result of such errors is that two floating-point values are rarely exactly equal. The value of parameter 144 represents the precision of comparison in places after the decimal point. If the parameter is set to 9.0, for example, then comparison operators will declare two numbers that differ in value by less than 0.0000000005 as being equal. The value 0.0 is a special value that turns comparison rounding off. When comparison rounding is off, it is up to the G code programmer to build the precision into conditional statements, for example "IF ABS[#A - #B] LT 0.00005 THEN GOTO 100". When comparison rounding is off, the "EQ" usually returns "false". If parameter 144 is set to 9, the programmer can shorten the previous example to "IF #A EQ #B THEN GOTO 100".

Parameter 145 – Advanced Macro Properties (Fast Branching)

This parameter turns fast branching on (1) and off (0). The other bits of this parameter are reserved for future use. If fast branching is disabled, the CNC software searches forward in the program for the first matching block number and resumes searching, if necessary, from the top of the program. For this reason, backward branches take longer than forward branches and backward branch times depend on the total program size. If the program is significantly large, use of the GOTO statement could introduce temporary pauses.

When fast branching is enabled, the CNC software remembers the locations of block numbers as it finds them during program execution. Backward branches always take place immediately. The first forward branch to a block not yet encountered will take additional time as the CNC software searches forward for the block number; however, subsequent forward branches to that block number will take place immediately. The trade-off for using fast branching is that all line numbers at a given level of program or subprogram must be unique and programs will use more memory (approximately 16kilobytes of memory for every 1000 block numbers in the program.)

Parameter 146 – Feed Hold Threshold for Feed Rate Override

This parameter sets the lowest value permitted as the feed rate override percentage before feed hold is engaged. Feed hold will be released when the override percentage is greater than this value.

Parameter 147 – Number of Status Messages to keep in Operator Message Window

The Operator Message Window is the box of scrolling status messages that appears in the upper right corner of the Main Screen. The number of remembered status messages can be adjusted by this parameter.

Parameter 148 – Miscellaneous Jogging Options

This parameter enables and/or disables certain optional modes of jogging.

Bit	Function Description	Parameter Value
0	Unused	Should be set to 0
1	Prohibit Keyboard Jogging	Prohibit Keyboard Jogging = 2 Keyboard Jogging allowed = 0

Note: With this parameter set to zero, you need to set parameter 170 to enable keyboard jogging.

Parameter 149 – Spindle Speed Threshold

This parameter defines the spindle speed threshold percent for the “Slave feedrate to spindle speed” function and the “Spindle up-to-speed” function, both of which are enabled and disabled via Parameter 78. It is specified as a percentage of the programmed spindle speed. For example a value of 0.8 means 80 percent of the programmed spindle speed. See Parameter 78 for more details.

Parameter 150 – Backplot Graphics display options

This parameter controls the various options related to backplot graphics.

Bit	Function Description	Parameter Value
0	Sets Run Time Graphics option default to ON	Enable = 1, Disable = 0
1	Displays CSR positions in graphing	Enable = 2, Disable = 0
2	Display A and B rotations for 5 axis machines	Disable = 4, Enable = 0
3	Display Skew Correction	Enable = 8, Disable = 0
4	Display Lash/Screw Compensation	Enable = 16, Disable = 0

Parameter 151 – Repeatability tolerance for probing and radial digitizing.

Default is 0, repeatability check disabled. When disabled, only one measurement per point is taken in the probing cycles and radial digitizing. When enabled, a minimum of two measurements are taken per point and the difference (if any) is then compared to the repeatability tolerance as set in Parameter 151. If the difference is less than or equal to parameter 151 the point is stored and probing continues. If the difference is greater than parameter 151, 2 more measurements are taken and the process repeated up to a maximum of 10 times. In probing cycles, if the repeatability tolerance cannot be met the cycle is cancelled and an error message generated. In radial digitizing, the point is discarded and digitizing continues without interruption.

Parameter 155 – Probe Type

This parameter specifies the type of probe being used.

Value	Meaning
0	Standard Mechanical probe
1	DSP probe
2	DP-7 probe

Parameters 156-159 – Autotune Move Distance / Auto Delay Calculation Move Distance for axes 5-8

See parameters 95 – 98 for more information.

Parameter 160 – Enhanced ATC

This parameter controls enhanced automatic tool changer (ATC) options. A value of 1 indicates a nonrandom type of ATC (carousel ATC) and a value of 2 indicates a random type ATC. A value of 0 disables enhanced ATC features. A warning is displayed when attempting to enable enhanced ATC features as these features work in conjunction with specific PLC programs. The enhanced ATC option has the following characteristics:

The beginning of an M6, whether it be a customized mfunc6.mac routine or not, flags the job file, setting the ATC error flag field to 1.

The end of an M6, whether customized or not, performs the following:

- The ATC error flag is set to zero.
- The tool number displayed on the screen is updated and this value is saved in the cncm.job file.
- The tool library bin fields are updated in this manner:

If there was a valid tool in the spindle at the start of the M6, then the tool library bin field for this tool will be updated with either the “putback” field for that tool (if nonrandom type) or the current ATC carousel position (for random type). For both random and nonrandom types, the “putback” field is set to 0. The “putback” field is an internal field for each tool in the tool library. It can be displayed by using the cncfcgutil utility with the –dt option to display the tool library.

For nonrandom types, the new tool now in the spindle will have its “putback” field updated to the current ATC carousel position.

For both random and nonrandom types, the new tool now in the spindle has the bin field set to 0.

The current ATC carousel position is constantly monitored. When there is a change, the ATC bin field in the cncm.job file is updated and the file is saved. The ATC carousel position is read from the PLC system variable SV_ATC_CAROUSEL_POSITION, which should be written by the PLC program.

At the start of running a job, to include MDI mode, the ATC error field is checked. If this field is 1, then a warning message is displayed with a prompt to either clear the fault by entering a ‘Y’ or canceling the job by pressing some other key.

A tool change is not performed if the requested tool is already in the spindle.

An M107 command sends the bin number for the specified tool number, not the tool number.

For random types, tool changes in Intercon are posted as a tool change (Tnn M6) followed by a pre-fetch command for the next tool in the program (Tn2 M107). This allows the PLC program to rotate the tool carousel to the next tool while a job continues with the current tool.

For random types, a job search for a tool number will look for lines of the form Tnn M6, i.e., the search bypasses lines of the form Tnn M107, which are just pre-fetch commands.

The tool library allows editing of the bin fields to specify which carousel bin number the tools are stored in.

Parameter 161 –ATC Maximum Tool Bins

This parameter sets the number of tool changer bins (carousel positions) used with the enhanced ATC option described above. PLC programs are responsible for reading this value. The tool library interface uses this parameter to validate bin fields and perform initialization of the bin fields.

Parameters 162 – Intercon M6 Initial M-Code

This parameter affects how Intercon programs post M&G codes for a tool change operation. When set to a non-zero value, Intercon will post out an M-code at the start of a tool change and an M5 command after the Txx M6 command. This parameter should be set to 17 so that Intercon will post an M17 code at the start of a tool change. The M17 command turns off spindle and coolant and starts the spindle orientation process.

Parameters 164 – ATC Feature Bit

This parameter controls specific features of the ATC system. It should be set to 1.0 to enable the ATC Reset feature, which will appear as the **F6 - ATC Reset** function key in the tool library menu. This parameter only works with ATC3 plc programs.

Parameters 165 – Acceleration/Deceleration Options

This is a bit field parameter which modifies certain details of axis acceleration and deceleration when an axis stops moving, changes direction, or starts moving. The Jog Parameters screen in the Machine Configuration set the original DeadStart values for each axis. This parameter allows you to modify these DeadStart settings under certain conditions. Note that if both Bits 0 and 1 are turned on (value = 1+2 = 3), the effect is cumulative, i.e. the net effect will be that ½ DeadStart value will be used when a slave axis stops or starts up from a stop. Likewise, if both Bits 2 and 3 are turned on, the effect will be cumulative also. Note that this feature has no effect for movement commands handled by Smoothing (P220=1).

Bit	Function Description	Parameter Value
0	Use ¼ DeadStart value for a slave axis that stops or starts from a stop	Enable = 1, Disable = 0
1	Use 2 x DeadStart value for a slave axis that stops or starts from a stop	Enable = 2, Disable = 0
2	Use ¼ DeadStart value for a slave axis that reverses	Enable = 4, Disable = 0
3	Use 2 x DeadStart value for a slave axis that reverses	Enable = 8, Disable = 0
4	Limit the feedrate along the path of G2 or G3 arc moves such that the feedrate will be uniformly limited to the lesser of the maximum rate of the 2 axes involved in the circular motion.	Enable = 16, Disable = 0

Parameters 166-169 – Axis Properties for axes 5-8

See parameters 91-94 for more information.

Parameters 170-179 – PLC Parameters

These parameters are especially reserved as a space for data which is to be sent to the PLC. Parameters 177, 178, 179 have been standardized for specific applications. Parameter 177 is used for trouble shooting purposes only.

Parameters 170 – Enable Keyboard Jogging and set Feedrate over ride Control

This PLC parameter is used to enable keyboard jogging and determine whether jog panel or keyboard feedrate over ride is used. To enable keyboard jogging set parameter 148 to zero and this parameter to a 1.

Bit	Function	Parameter Value
0	Enables Keyboard jogging	Enable = 1, Disable = 0
1	Only looks at Feedrate over ride from Jog panel	Enable = 2, Disable = 0
2	Only looks at Feedrate over ride from keyboard	Enable = 4, Disable = 0

Parameter 178 – PLC I/O configuration

This parameter can be use to set switch types from NC to NO and some other options. Each Bit corresponds to a different function. All values are to be added to the current setting. For example, if you need to switch the low lube input to normally open add 1 to this parameter. **NOTE:** This parameter works only with specific PLC programs. The PLC program installed in the control MAY NOT be mapped as indicated below. These parameters should only be changed by a qualified technician. The example given below is intended for reference only:

Bit	Function	Default state	Opposite State
0	Lube Fault	Closed = OK	Add 1
1	Spindle Fault	Closed = Fault	Add 2

179 – Lube Pump Operation

This parameter can be configured to control a variety of lube pumps. The value is formatted as MMMSS, MMM for minutes and SS for seconds. Below is a table of some examples.

Type of Pump	MMM	SS	Operation
Mechanical/CAM	0	0	179=0 Power is on when machine is running a job or in MDI Mode
Electronic “lube first”	16	00	179=1600 Holds power on to the pump for 16 minutes of job or MDI time
Electronic “lube last”	16	00	179=1600 Holds power on to the pump for 16 minutes of job or MDI time
Direct Controlled Pump	30	15	179=3015 Waits for 30 min of job or MDI time, then applies power for 15 seconds.

Parameters 186 – Probe Stuck retry disable

This parameter is used to disable retries when a probe is detected to be in a “stuck” condition. A probe “stuck” condition occurs during a probing move when a probe’s red light (LED) stays on even after the probe has moved clear of the contact surface. The control can sometimes detect this condition and go through a series of corrective moves to “reseat” the probe and retry the probing move. If this parameter is set to a non-zero value, then the control will not do this corrective action nor attempt another probing move. If this parameter is set to 0, then the control will go through the corrective action and retry the probing move up to 5 times.

Parameters 187 – Hard Stop Homing

This parameter is used when homing off hard stops. The value set in this parameter determines the amount of current sent to the motor while homing. Value range is 0-32000; typical value for a DC system is 16000. Note that this feature does not work with velocity mode drives.

Parameters 188-199 – Aux Key Functions

These parameters are used to assign a function to aux keys 1-12 (i.e. P188 = Aux1 ... P199 = Aux12). The following is the list of possible functions that can be executed when an aux key is pressed.

Function	Parameter Value
No Function	0
Input X Axis Position	1
Input Y Axis Position	2
Input Z Axis Position	3
Set Absolute Zero	4
Set Incremental Zero	5
One Shot - Drill	6
One Shot - Circular Pocket	7
One Shot - Rectangular Pocket	8

Function	Parameter Value
One Shot - Frame	9
One Shot - Face	10
Execute M Code file	m11*
Free Axes	14
Go to Power Feed Menu	15
XYZ Set Absolute Zero	16
One Shot - Drill Bolt Hole Circle	17
One Shot - Drill Array	18

For example, if you wanted Aux4 to call up the “One Shot - Circular Pocket” , you would set parameter 191 to 7.

The Input Axis Position functions must be used with the Set ABS/INC Zero functions. After entering the desired value at the input field provided by the Input Axis Position function, press an aux key assigned either the function Set ABS Zero or Set INC Zero.

* *m* is the number of the M code to execute. For example, if the parameter value is set to 7211, the file mfunc72.mac will be loaded and executed when the Aux key was pressed.

Custom overlays with the keys that represent these functions are available; contact your dealer for pricing.

Parameters 200-207– OPTIC 4 Tach Volts Per 1000 RPM

These parameters control the digital Tach output on the Optic4 boards. They are used on drives like old Fanuc velocity mode drives that require a tach input. The value put here is the volts/1000 RPM off of the motor. A negative value can be entered to invert the tach voltage compared to the encoder count derived velocity direction from the encoder.

Parameters 208-215 MPU-based Lash/Screw Compensation Acceleration Coefficient

These parameters control the speed of the Lash and/or Screw Compensation for axes 1-8. The lash will be taken up with acceleration equal to the coefficient multiplied by the acceleration rate for the axis. A value of zero would effectively disable MPU-based Lash and/or MPU-based Screw Compensation.

*NOTE: These coefficients are not used by PC-Based Lash nor PC-based Screw Compensation

Parameters 216 PC Based Lash Compensation on/off

This parameter controls which Lash Compensation Algorithm to use. The default value of 0 is recommended because it allows lash compensation to occur during any kind of motion. If PC Based lash is used then only during an MDI or programmed move (but not during jogging) will lash compensation be applied.

Function	Value
Use MPU-Based Lash Compensation	0
Use PC-Based Lash Compensation	1

*NOTE: Lash/Screw Compensation Acceleration Coefficients (parameters 208-215) are not used by PC-Based Lash Compensation.

Parameters 217 PC Based Screw Compensation on/off

This parameter controls which Screw Compensation Algorithm to use. The default value of 0 is recommended because it allows screw compensation to occur during any kind of motion. If PC-Based screw compensation is used then only during an MDI or programmed move (but not during jogging) will screw compensation be applied.

Function	Value
Use MPU-Based Screw Compensation	0
Use PC-Based Screw Compensation	1

*NOTE: Lash/Screw Compensation Acceleration Coefficients (parameters 208-215) are not used by PC-Based Screw Compensation.

Parameters 220-231 – Smoothing Parameters

These parameters are used for controlling the behavior of the Smoothing feature used during feed per minute moves. In particular, parameter 220 turns Smoothing on or off. When Smoothing is turned on, extreme care must be practiced to ensure that the rest of the Smoothing parameters are set to reasonable values, or else damage to the machine may result. *For further Smoothing information, please see the sections “Smoothing Configuration Parameters” and “Smoothing Setup Menu” later in this chapter.*

Parameters 236-239 – Motor Cooling Coefficients for axes 5-8

See parameters 20-30 for more information.

Parameters 252-255 – Autotune Ka Performance parameters for axes 5-8

See parameters 87-90 for more information.

Parameters 256 – Drive Mode

This parameter indicates to the control software what mode the drives are operating under. It also controls the availability and behavior of the F5 Tune key in the PID Menu based on the drive mode.

Drive mode	Value
Torque mode. Autotune feature is enabled, accessible via F5 in PID Menu	0
Velocity mode. Autotune feature is disabled. Autotune does not work with velocity mode drives and therefore this parameter should be set to 1 to prevent access to Autotune on such machines with these drives.	1
Precision mode. This enables the Precision Mode delay parameters 340-347. This also enables the Auto Delay Calculation feature, accessible via F5 in PID Menu, which is used to automatically calculate these parameters.	2

Parameter 257 – TT1 connection detection PLC input

This parameter stores the input for the TT1 connection detection feature. The spindle inhibit parameter (parameter 18) must be set (non-zero) for this feature to work. The default for this parameter is 0, which disables this feature. When this parameter is set (non-zero), the Tool Measuring cycle will not run unless a TT1 or a probe is connected. A negative value must be entered if a "normally closed" input is to be used with the control. A positive value must be entered if a "normally open" input is to be used with the control. The absolute value of this parameter will directly reflect the PLC input the TT1 connection detect is wired to.

Parameter 258 – Velocity/Torque Mode override in Precision mode

This is an axis bitfield where setting a bit to 'on' allows the corresponding axis to run as if it were in velocity or torque mode, but prone to servo mismatch errors. Bit 0 (value 1) refers to axis #1, bit 1 (value 2) refers to axis #2, bit 2 (value 4) refers to axis #3, bit 3 (value 8) refers to axis #4, and so forth.

Parameter 260 – Accelerated Graphics Backplot

This parameter controls the user interface that is presented when **F8 – Graph** is pressed. See Chapter 3 for more information about Accelerated Graphics Backplot.

Function	Value
Use the original Graphics Backplot	-1
Use the new Accelerated Graphics Backplot	1

Parameter 270-271 – XY Skew Correction

These parameters work together to correct XY position skew, which can occur if the X axis is not exactly perpendicular to the Y axis (or vice versa). To turn on XY skew correction, use the chart and follow the skew measurement procedure described below. To turn off XY skew correction, set both parameters to 0.

Parameter	Symbol	Description
270	S	+/- X skew deviation from perfect X and perfect Y
271	L	Y length over which to apply a position correction to counteract a skew of amount S

Skew Measurement Procedure:

Program a sufficiently large L x L square and cut it on a scrap piece of material using the machine in question. Put this “square” piece against a true square corner and measure the skew S. If the square is leaning to the left, then S is negative; if it is leaning to the right, then S is positive. Set Parameter 270=S and Parameter 271=L.

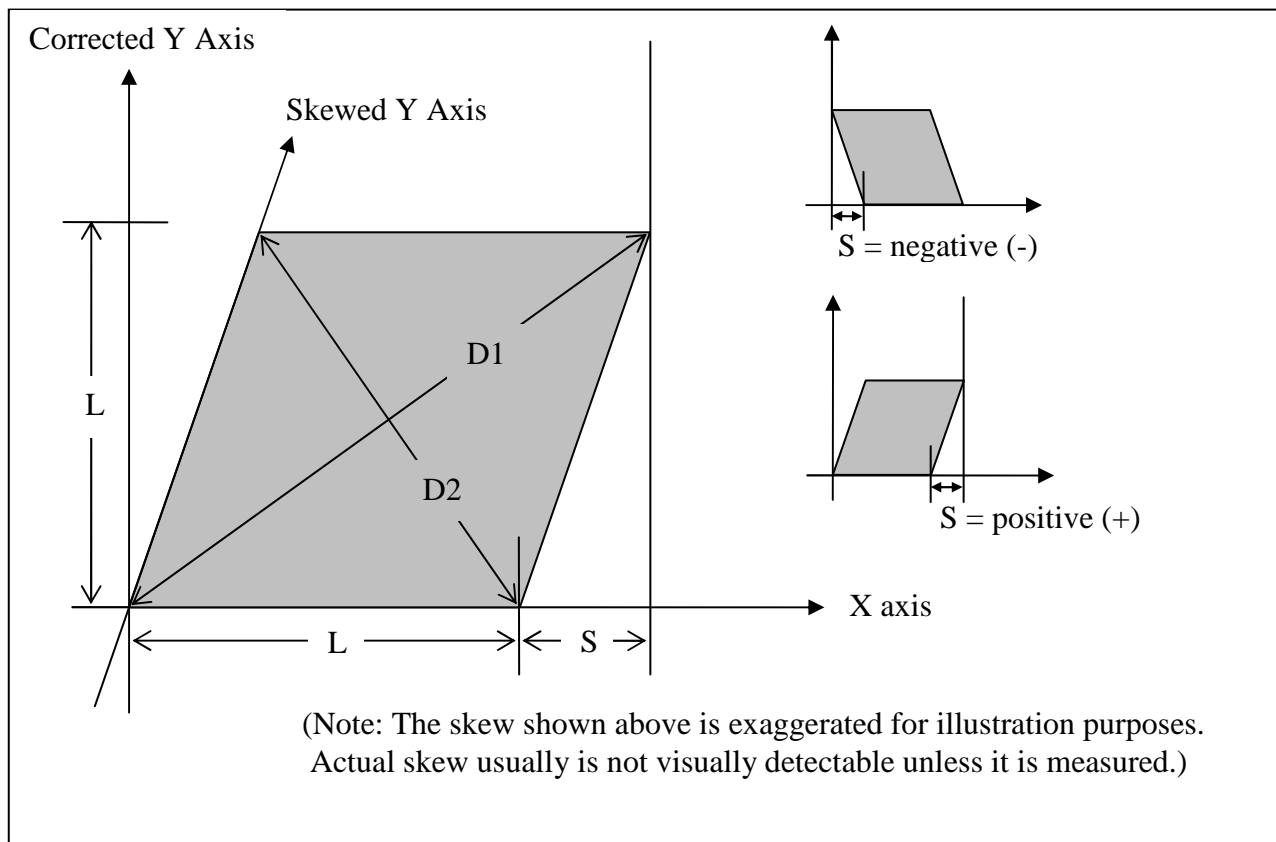

If you have trouble directly measuring S, you can calculate it by measuring the diagonals D1 and D2, and then using the following formula:

$$S = \frac{D1^2 - D2^2}{4 \times L}$$

Parameter 284-291 – Brake Resistor Wattage for ACDC Drives 1-8

These parameters specify the brake resistor wattage which default to the minimum internal resistor value. If CNC11 detects that the estimated brake wattage exceeds these parameter settings, then a "470 _ axis (drive _) brake wattage exceeded" message is reported in the status window and written to the message log. These warnings may be written at most twice a minute. User variables #27201-#27208 can be used in an M- or G-code program to return the estimated brake wattage as reported by the ACDC drive to MPU11. Note that these are drive numbers, and match the LED indicator on the ACDC drive, but do not necessarily match the axes as displayed in the DRO due to the flexibility of drive mapping.

Parameter 300-307 – Drive assignment to Axes 1-8

These parameters control to what physical drive the commands for motion are sent. Parameter 300 assigns a physical drive to axis 1, parameter 301 assigns a physical drive to axis 2, and so on. The values for these parameters can be set to any value from 1-25 based on the table below. **These parameters must be set before attempting to move motors. Note that if you change any of these values, the machine must be powered down and restarted for the changes to take effect. Contact your dealer before changing these values.**

Drive Number Assignment	Drive Type and Location	Description
1,2,3,4,5,6,7,8	Drive Bus Channel 1-8	Drive types are DC3IOB, DC1, ACSINGLE, OPTIC4, and OPTICDIRECT. Other drive types may be added in the future.
9, 10, 11, 12	GPIO4D/RTK4 Drive Out 1-4	Drive output is implemented as outputs on the PLC bus which are updated at 4000hz.
13	RTK4 Drive Out 5	5 th output for RTK4 drive
14-16	Reserved	
17, 18, 19, 20	Legacy DC 1-4	Examples of Legacy DC drives are: QUADDRV1, SERVO1, M15DRV1, DC3IO, SERVOLV, SERVO3IO, DCSINGLE.
21,22,23,24,25	Legacy AC 1-5	Examples of Legacy AC drives are: SD1, and SD3.

Parameter 308-315 –Encoder assignment to Axes 1-8

These parameters control to which encoder the axis should look for feedback. Parameter 308 assigns an encoder to axis 1, parameter 309 assigns an encoder to axis 2, and so on. The values for these parameters can be set to any value from 1-15 based on the table below. **These parameters must be set before attempting to move motors. Note that if you change any of these values, the machine must be powered down and restarted for the changes to take effect. Contact your dealer before changing these values.**

Encoder Number	Location	Description
1	MPU11 onboard encoder 1	Encoder inputs on the MPU11.
2	MPU11 onboard encoder 2	
3	MPU11 onboard encoder 3	
4	MPU11 onboard encoder 4	
5	MPU11 onboard encoder 5	
6	MPU11 onboard encoder 6	
7	Drive Bus Channel encoder 1	Encoder inputs on Drive Bus devices. Here are some examples: One DC3IOB would occupy 3 Drive Bus Channel encoder locations numbered 7,8,9. Two DC3IOB's chained together would occupy 6 Drive Bus Channel encoder locations numbered 7,8,9,10,11,12. An OPTICDIRECT occupies 1 Drive Bus Channel encoder location. Chaining 8 OPTICDIRECTs together would occupy 8 encoder locations numbered 7-14. Legacy AC drives (such as SD1 or SD3) occupy 6 encoder locations numbered 7-12. Note that every Drive Bus device takes up a Drive Bus encoder location even if there is no encoder going to the drive.
8	Drive Bus Channel encoder 2	
9	Drive Bus Channel encoder 3	
10	Drive Bus Channel encoder 4	
11	Drive Bus Channel encoder 5	
12	Drive Bus Channel encoder 6	
13	Drive Bus Channel encoder 7	
14	Drive Bus Channel encoder 8	
15	MPU11 onboard MPG encoder	MPG connector with no index pulse

Parameter 323 – MPU11 Encoder Speed Filter

This is an axis bitfield where setting a bit to ‘on’ selects the low speed filters for the corresponding axis. As a general guideline, an axis’s bit should be set unless that axis refers to a 3rd party drive. Bit 0 (value 1) refers to axis #1, bit 1 (value 2) refers to axis #2, bit 2 (value 4) refers to axis #3, bit 3 (value 8) refers to axis #4, and so forth.

Parameter 324-331 – Axis Boxcar Size

These parameters set the maximum sample size of the boxcar filter for each axis. For most applications these values should be set to 0 (default). For applications where the motor drives are too responsive or jumpy, these boxcar filters act as a way to smooth the PID output. They average the PID output by the entered boxcar size thus reducing PID spikes. Eg. A value of 4 would add the last 4 PID values and then divide by 4 for before output. A value of 5 would add the last 5 PID values then divide by 5 before output. Note that during PID averaging, the Error Sum is not zeroed during direction reversal. Conversely, a value of 0 disables the boxcar filter for that axis and also zeroes the Error Sum on Direction Reversal. Note also that as a byproduct of averaging by 1, a boxcar value of 1 may be used to produce a true PID output while not zeroing the Error Sum on direction reversal.

Parameters 332-335 – Encoder error suppression

These parameters control suppression of various types of encoder errors on a per encoder basis. These parameters are bitfields by encoder index, NOT axis index. The mpu11 has 15 encoder indexes. For example to disable encoder faults for Encoder #5 on the mpu11, enter a 16 into the parameters 332 and 334. To suppress encoder faults and error messages for all 8 axes, enter 255 into each of the parameters mentioned in the following table.

Parameter	Function
332	Suppress encoder differential faults
333	Suppress encoder differential error messages
334	Suppress encoder quadrature faults
335	Suppress encoder quadrature error messages

Parameters 336-339 – Motor torque estimation for velocity mode drives

These parameters are intended to be used with velocity mode drives in order to facilitate a more accurate display of the axis load meter bars shown under each position in the main DRO display. If P336 = 0, then this feature is disabled and the normal PID output is displayed by the axis load meter bars. This feature is enabled if P336 is non-zero.

Parameter	Symbol	Function
336	G	Overall gain setting (0 = disable Motor torque estimation)
337	Ga	Absolute error gain
338	Gs	Error sum gain
339	Gd	Delta error gain

Technical details:

The axis meter bar value (V) is then calculated as: $V = \text{abs}(100.0 * G * ((Ea * Ga + Es * Gs + Ed * Gd)) / \text{integration_limit})$, where Ea is the absolute error, Es is the error sum, and Ed is the delta error from the PID algorithm and the integration_limit is from the “Limit” value set in the PID Config screen. This value V is then bound to the range 0-100.

Parameters 340-347 – Precision Mode delay (in milliseconds) for axes 1-8

These parameters are used for synchronizing individual precision mode drives with different delays. The MPU11 will use these values and compensate for the differences in the delays. These parameters have up to a 0.25 millisecond resolution.

Parameter 348, 351, and 354 – MPG/Handwheel Encoder Input 1, 2, and 3

The encoder input for the MPG or handwheel. (1-15) See the encoder chart above. Note: PLC program interaction is needed to enable an MPG or handwheel.

Parameter 349, 352, and 355 – MPG/Handwheel Detents per Revolution 1, 2, and 3

This value is the number of clicks (detents) per revolution. It is the number of divisions or markings on the mpg or handwheel. Moving the mpg or handwheel one detent or division will cause the motor to move one jog increment (depending on the multiplier x1, x10, x100, etc). . Note: PLC program interaction is needed to enable an MPG or handwheel.

Parameter 350, 353, and 356 –MPG/Handwheel Encoder Counts per Revolution 1, 2, and 3

This value is the number of counts generated per rotation of the mpg or handwheel. Note: PLC program interaction is needed to enable an MPG or handwheel.

Parameters 357-364 – Axis Drive Max RPM for Axes 1-8

These parameters allow you to set the drive/motor max rate capability (in RPMs) for use by the PID algorithm for the calculation of the axis KV1 contribution. This value is independent from the axis Max Rate setting in the Jog Parameters menu, which is used by the control software. However, for those axes whose corresponding parameters are set to 0 (the default) the the PID algorithm will use the axis Max Rate setting in the Jog Parameters for the calculation of the axis KV1 contribution. These parameters are intended for 3rd party velocity mode drives that have a different max rate setting than that of the control software.

Parameters 365 – Drive power-on delay

This specifies the number of milliseconds that the MPU11 will wait between the moment that drive power first comes on and the start of commanded motion. However, this does not work for the case of turning off a single axis using M93, moving a different axis, and then moving the powered off axis. The default value is 0 which means no delay.

Parameters 366 / 367 – Probe / TT1 deceleration multiplier

Parameter	Function
366	Probe deceleration multiplier: This factor adjusts the deceleration rate of probing moves coming to a stop due to probe hit.
367	TT1 deceleration multiplier: This factor adjusts the deceleration rate of TT1 tool measuring moves coming to a stop due to tool touch detect.

The normal axis acceleration rate (configured by dividing the Max Rate in the Jog Parameters screen by the Accel Time in the PID Config screen) is multiplied by the value of these parameters to determine the actual decelerations used for each situation. A value higher than 1 will cause a more abrupt deceleration than the normal axis configuration. A value below 1 will cause a gentler deceleration.

Parameters 374-379 – ACDC Drive Debug Log Settings

These parameters are used by support technicians and should be left at value 0.

Parameters 392-394 – DP-7 parameters

These are parameters specific to the DP-7 probe and are used only if parameter 155 = 2.

Parameter	Function
392	DP-7 Pullback Distance: The distance the probe moves off of the surface after a probing move.
393	DP-7 Pullback Feedrate: The feedrate for the pullback move.
394	DP-7 Measuring Feedrate: The feedrate for the slow measuring move.

Parameters 395 – Probing Setup Traverse Speed

This sets the probing traverse feedrate for the macro-based probing cycles on engine block systems.

Parameters 396 – Probing Setup Plunge Speed

This sets the probing plunge feedrate for the macro-based probing cycles on engine block systems.

Parameters 398 – Port/Block mode

This determines the current mode of Port/Block systems and is set by the Port/Block menu. This parameter should not be manually modified.

Value	Mode
0	3-Axis
1	Engine Block
2	Tilt Table

Parameters 399 – AD1 arc chord tolerance adjustment

This parameter adjusts the precision of AD1 arcs. When Smoothing is turned off (P220 = 0) arc moves (such as G2 and G3) are generated as a string of many small linear moves that are used to closely approximate the programmed arc. These small linear moves are called arc chords. These arc chords straddle each side of the theoretical true arc path, but their distance (in encoder counts) from the path is limited by what value is set in this parameter. The default value is .5, meaning that by default the arc chord never strays away from theoretical true arc by more than ½ encoder count.

Parameters 900-999 – PLC program parameters

These parameters are used as a way of communicating floating point values to a PLC program. The meanings of these parameters depends on how a PLC program uses them and can vary from one machine to another. One suggested use of these parameters is as a set of configuration values. The values of these parameters are saved upon modification (via a menu or CNC job) and will be retain their values even after shutdown and restart of the control software.

All remaining parameters are reserved for further expansion.

PID Menu

Pressing **F4 - PID** from the Configuration screen will bring up the PID Menu. The PID Menu provides qualified technicians with a method of changing the PID dependent data to test and configure your machine.

WCS #1 (G54) Current Position (Inches) Job Name: MUSTANG .cnc

X	+0.5000	Tool: T1 H1	Feedrate: 120%	Part Cnt: 0
Y	+0.0000	Spindle: +0 A		Part # □: 24
Z	+0.0000			
A	-0.0010°			
B	-0.0001°			

305 Processing...
 313 Waiting for dwell time
 302 Moving...
 313 Waiting for dwell time
 307 Operator abort: job cancelled
 301 Stopped

Press CYCLE START to start job

PID Menu

Axis	Error	Sum	Delta	PID Out	Abs Pos	Max Error	Min Error
X	0	17	0	1	20000	3	-3
Y	0	15	-1	-2	-1	3	-2
Z	-1	7	0	-2	1	2	-2
A	-1	164	0	-1	-1	-2	-2
B	0	158	1	1	1	-2	-2
N*	0	0	0	OFF	-1	0	0
N	0	0	0	OFF	0	0	0
N	0	0	0	OFF	0	0	0

PID Config
F1

Tune
F5

Drag
F6

Laser
F7

Drive
F8

Plot
F9



WARNING

The PID Parameters **should not** be changed without contacting your dealer. Corrupt or incorrect values could cause damage to the machine, personal injury, or both.

F1 - PID Config

This option displays the Oscilloscope tuning screen, and is intended for qualified technicians **only**. It allows technicians to modify the PID values, and to see (in real time) the effects of those modifications. Altering the PID values will cause **DRAMATIC** changes in the way the servo system operates, leading to possible machine damage. **DO NOT** attempt to change these parameters without contacting your dealer.

The general idea is to reduce the Absolute Error (ErrAbs) and the Sum of Absolute Error (ErrSum), which are both measured in encoder counts. Absolute Error tells you how far off position the machine is at any particular point in time, and the Sum is used when tuning to make sure the overall error is being reduced.

Special Note for SD3 drives: The program containing test moves (edited via F1 and run via F2 on the Oscilloscope tuning screen) must contain a dwell (G4 P__), otherwise the SD3's drive parameters will not be sent.

Axis X - Looping	Scale	Offset	Value
0.000, 0.000	1.00	0.00	-0.019
VExp Visible	1.00	0.00	0.000
VAbs Visible	1.00	0.00	-1.000
ErrAbs Visible	0.01	0.00	4.000
ErrSum Hidden			

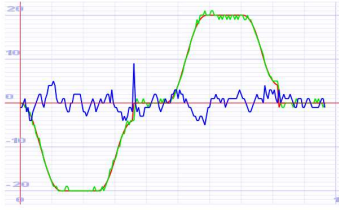

Axis	Kp	Ki	Kd	Limit	Kg	Kv1	Ka	Accel.	Max Rate
X	0.1290	0.003052	0.7813	128000	0.0000	0.0000	0.0000	0.2000	(300.0)
Y	0.1290	0.003052	0.7813	128000	0.0000	0.0000	0.0000	0.2000	(300.0)
Z	0.1290	0.003052	0.7813	128000	0.0000	0.0000	0.0000	0.2000	(300.0)
A	0.5000	0.003052	0.4883	32000	0.0000	0.0000	0.0000	0.2000	(10000.0)
B	0.5000	0.003052	0.4883	32000	0.0000	0.0000	0.0000	0.2000	(300.0)
N	0.5000	0.003052	0.4883	32000	0.0000	0.0000	0.0000	0.2000	(10000.0)
N	0.0000	0.000000	0.0000	0	0.0000	0.0000	0.0000	0.0000	(0.0)
N	0.0000	0.000000	0.0000	0	0.0000	0.0000	0.0000	0.0000	(0.0)

Autotune Last Run On Thu Mar 25 14:19:29 2010 v. 3.00
Autotune suggested values: 0.0000 1.0000 36.0000 0.1000 (300.0)

Edit Program	Run Program	Ranges	Toggles & Pan	Zoom In	Zoom Out	Zoom All	Change Axis	Save & Apply	Save & Exit
F1	F2	F3	F4	F5	F6	F7	F8	F9	F10

F1 – Edit Program

Change the program that will run when F2 is pressed

F2 – Run Program

Causes the machine to run a simple test program, while collecting data

F3 – Ranges

Can be used to specify the X and Y ranges for the Oscilloscope view

F4 – Toggles & Pan

Allows changes to how the collected data is displayed, and panning via the cursor keys

F5 – Zoom In

Zooms in

F6 – Zoom Out

Zooms out

F7 – Zoom All

Fits all of the collected data into the Oscilloscope view

F8 – Change Axis

Tells the MPU11 to collect data for a different axis (displayed in the top left)

F9 – Save & Apply

Saves any modifications

F10 – Save & Exit

Saves any modifications and exits the Oscilloscope menu

Page Up – Tweak +

Allows small modifications (+1%) to the PID values while the program is running. Hold shift for a larger (+10%) modification.

Page Down – Tweak -

Allows small modifications (-1%) to the PID values while the program is running. Hold shift for a larger (-10%) modification.



WARNING

Improper PID values can ruin the machine, cause personal injury, and/or destroy the motor drives!!!

F5 - Tune

This option is available only for Torque mode and Precision mode drives. See Parameter 256 earlier in this chapter for more information about Drive modes.

If the drives are in Torque mode, pressing this key will start the Autotune procedure. It is used by qualified technicians to automatically determine values for Max Rate, Accel/decel time, and Deadstart (See section Motor Configuration: Jog Parameters) as well as certain PID parameters for each installed axis. The Autotune procedure will make a series of moves on each non-paired controlled axis, traveling a limited distance (configured via parameters 95-98 and 156-159) from the initial position in all directions to determine the friction and gravity of each axis. The initial high-speed move will use half of this distance. You cannot run Autotune on paired axes. Do not run Autotune unless requested to do so by a qualified technician.

If the drives are in Precision mode, pressing this key will start the Auto Delay Calculation procedure. It is used by qualified technicians to automatically determine values for the Precision Mode delay parameters 340-347. The Auto Delay Calculation procedure will make a single move on each non-paired controlled axis, traveling a limited distance (configured via parameters 95-98 and 156-159) from the initial position. You cannot run the Auto Delay Calculation procedure on paired axes. Do not run the Auto Delay Calculation procedure unless requested to do so by a qualified technician.

F6 - Drag

This option is used by qualified technicians to determine whether your machine is binding anywhere along the axis travel. To run a drag test press **F6 - Drag** to begin the drag test. Press **F1 - Next Axis** to select the axis you wish to check and then hit the CYCLE START button. A text file drag_x.out, or a similarly named file is generated and stored in the c:\ncm directory. If significant drag occurs, a message will be displayed on-screen. Contact your dealer to correct the problem as soon as possible.

F7 - Laser

This option is used by qualified technicians to take automated laser measurements and create or adjust the ballscrew compensation tables. Do not attempt to run automatic laser compensation without first contacting your dealer for details.

F8 - Drive

This menu will only appear on AC systems and only affects using SD or ACSingle drives. It is not for general viewing and definitely not for modification by any unqualified individual. For more information about this menu option, refer to the SD installation manual.

F9 - Plot

This option is used by qualified technicians to plot data.

Test

This menu only appears if the system has not yet been configured and initialized or if a new solid state disk has been installed. For more information, please contact your dealer.

ATC Init.

This menu will only appear on enhanced ATC systems. Please see your ATC manual for further information.

DSP Probe Configuration

Pressing **F7 – DSP Probe** from the configuration screen will display the DSP Probe configuration. Note that this menu is available only for DSP probes (Parameter 155=1).

WCS #1 (G54)	Current Position (Inches)	Job Name: thread.cnc
X 	-6.4839	Tool: T1 H1
Y	+10.3858	Feedrate: 100%
Z	+19.4561	Spindle: 0 A
A	0.000°	
DSP Probe Settings		
DSP to Mechanical: Minimum Difference	0.00100	inches
DSP to Mechanical: Maximum Difference	0.02500	inches
DSP Probing Probing Feedrate	20	inches/minute
DSP Probing Clearance Feedrate	20	inches/minute
DSP Retry Limit	10	times
Force DSP Probing Feedrate in M115/M116?	yes	yes/no
Accept mechanical points in digitizing cycles?	no	yes/no
DSP Retry Dwell Time	0.0000	seconds

335 Emergency stop released
301 Stopped

Press CYCLE START to start job

Accept
F10

Minimum Difference:

Default - 0.001 inches. The minimum difference between mechanical and reported DSP position.

Maximum difference:

Default - 0.025 inches. The maximum difference between mechanical and reported DSP position.

DSP Probing feedrate:

Default – 20. The feedrate to use for DSP probing moves.

DSP Probing Clearance feedrate:

Default – 20. The feedrate to use for DSP probing Clearance moves.

DSP Retry Limit:

Default - 10 times. The maximum number of tries to achieve a passing window.

Force DSP probing feedrate in M115/M116:

Default - Yes. This forces the DSP feedrate for M115/M116 (recommended) rather than using the feedrate specified in an F command.

Accept Mechanical Points in Digitizing Cycles

Default –Yes. Used when any given point has failed window checking # times where # = the limit as specified in DSP Retry Limit. Setting this option to **Yes** records the last mechanical position rather than throw out the point entirely. If this option is set to no, no value is recorded for the point and digitizing continues.

DSP Retry Dwell Time

Default – 0 seconds. The amount of time to dwell at the end of a retract move when retrying a DSP probing move. The purpose of this is to give the probe time to stop vibrating before moving towards the surface again on a bad hit.

Other DSP Probe settings

The DSP Probe eliminates the need for a multiple-hit probe measuring move (A fast inward move to find the surface followed by a slow move to measure the surface). Therefore, the Slow Probing Rate (parameter 15) does not apply to probing moves when the DSP probe is enabled. However, the Slow Probing Rate still applies to TT1 tool measurements. The Fast Probing Rate (parameter 14) is still used for positioning moves in digitizing cycles, but not for probing moves which measure the surface. Instead, the DSP Probing feedrate is used for these moves.

The following list is a list of other parameters which affect the DSP Probe. See the parameter descriptions in the Machine Parameters section (earlier in this chapter) for more information.

Probe Type (Parameter 155):

This parameter enables/disables the DSP Probe.

Recovery Distance (Parameter 13):

This parameter is used for failed DSP windows. On a failed window, the DSP probe will retract this distance before retrying.

Fast Probing Rate (Parameter 14):

Used for positioning moves in digitizing and probing routines. These are moves which are not measuring a surface. It is not used for surface measuring moves when the DSP probe is enabled.

Slow Probing Rate (Parameter 15):

Not used by the DSP probe. However, it will still be used by TT-1 tool measurements.

Repeatability Tolerance (Parameter 151):

Recommended value is 0 (disabled). This parameter enables repeatability checking. It will work in conjunction with the DSP probe.

Smoothing Configuration Parameters

Parameter	Description	Recommended values	
220	Turn the Smoothing feature ON or OFF .	1 = Smoothing (set to 0 to use Exact Stop mode)	
221	NBpts: The number of points in the Smoothing filter. The higher this value, the more rounded corners will become (see tolerance below)	For Milling Machines: 0 to 10	For Routers: 5 to 20
222	STEP: Smoothing breaks up a G code program into segments of this vector size. Use this rule of thumb: Tolerance = (Nbpts*STEP)/3.	For Milling Machines: .001 inch / .025mm	For Routers: .01 inch / .25mm
223	Umax: Sustained safe throughput rate going to the CPU10/MPU11 card.	800	
224	Centripetal control options: This bitfield parameter controls the Centripetal stage of the Smoothing module. Value 0 (default) makes Centripetal operate on all axes and disables excessive axis accel checking. Values 1 and 3 (bit 0 = 1) limits Centripetal to only linear axes. Values 2 and 3 (bit 1 = 1) enables excessive axis accel checking	0 (Centripetal stage will operate on all axes and disables excessive axis accel checking.)	
226	W: Feature Width over which the Min Angle is determined.	10	
227	Min_Angle: Minimum angle to smooth in degrees. Settings of 95 to 100 degrees will come to a near stop and produce sharp right angles. 60 to 85 will move continuously while rounding angles.	For Sharp corners 95 to 100 degrees	For rounded corners 60 to 85 degrees
228	S curve: The recommended setting for this parameter is 0.	0 = Off completely (recommended setting)	
229	Backplot/Smoothing mode : Smoothing may slow down the display of Backplot Graphics. This parameter allows a faster backplot by not showing Smoothing.	0 = Faster Backplot, smoothing may be active but is not shown 1 = Slower Backplot, smoothing effects shown.	
230	Curve Feedrate Multiplier: Reducing this value below 1.0 will cause the machine to move slower around curves and corners, minimizing "bangs" and overshoots. Increasing this value above 1.0 may allow you to run your machine faster if the feedrates in arcs and corners are still satisfactory.	1.0 (default value) 0.1 to 5.0 (Depending on user's preference for speed vs "bangs" and overshoots)	
231	Acceleration Multiplier: This parameter allows you to adjust the overall acceleration / deceleration rate as a means to reduce machine vibration, and noise during starting, stopping and feedrate changes. Reducing this value below 1.0 will cause more gentle accelerations and decelerations. Increasing this value above 1.0 will cause faster accelerations / decelerations.	1.0 (default value) 0.5 to 1.5 (Depending on user's preference for quickness of accelerations / decelerations)	

Note: STEP must be in the same units that the control is currently set to (Inches or MM). Once entered in, if you change units in the control from inches to mm or vice versa the Smoothing parameters will automatically be converted to the other units for you, so you don't have to re-enter them once you've type them in properly.

Technical Background description of Smoothing :

Smoothing performs several related functions:

1. Smoothing NBPTS (P221) and STEP (P222)

These parameters control geometrical smoothing of the user supplied G-code. Smoothing allows significantly higher feedrates to be achieved while reducing vibration, bumps and bangs at corners and angles. It is also great for smoothing over a CAD-CAM generated data with peculiar features. See Fig 1. Smoothing's strength is also a potential disadvantage, it modifies geometry and rounds corners. See Fig 2. When would you want to use smoothing? The user may want to run smoothly through rectangular Z movements created by "breakout tabs" on a router job. Smoothing will allow the job to run at high speed right through the breakout tabs, if the min angle P227 is set to less than 90 degrees.

Fig 1. Basic action of Smoothing

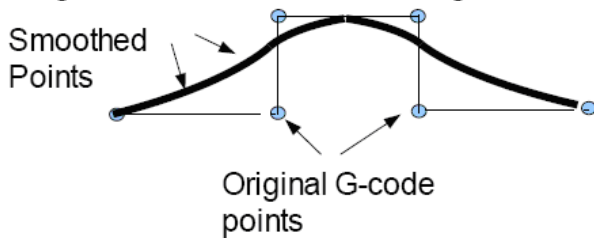

Fig. 2 Rule of thumb for estimating Smoothing tolerance $\approx (NBPTS * STEP)/3$

Example: for NBPTS= 5 , and STEP= .001
 $5 \times .001 ; .005/3 \approx .00167$ in Smoothing Tolerance

Gives an estimate of the smoothing tolerance
 When rounding a 90deg corner, assuming
 That the min angle P227 is less than 90deg

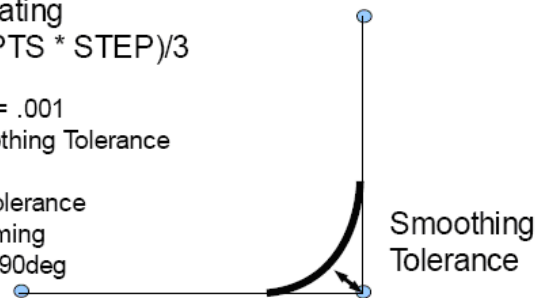
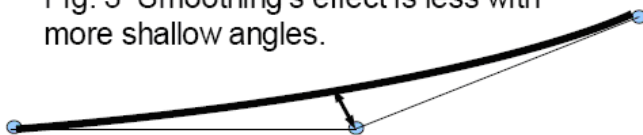

Fig. 3 Smoothing's effect is less with more shallow angles.



2. P230 Curve Feedrate multiplier Arcs and Corners

Low values produce lower feedrates in curves.

Fig. 4a: P230 determines speed around curves and arcs



Tighter arcs produce lower feedrates

3. P231 Acceleration Multiplier

Fig. 4b: Lower values produce lower accelerations.

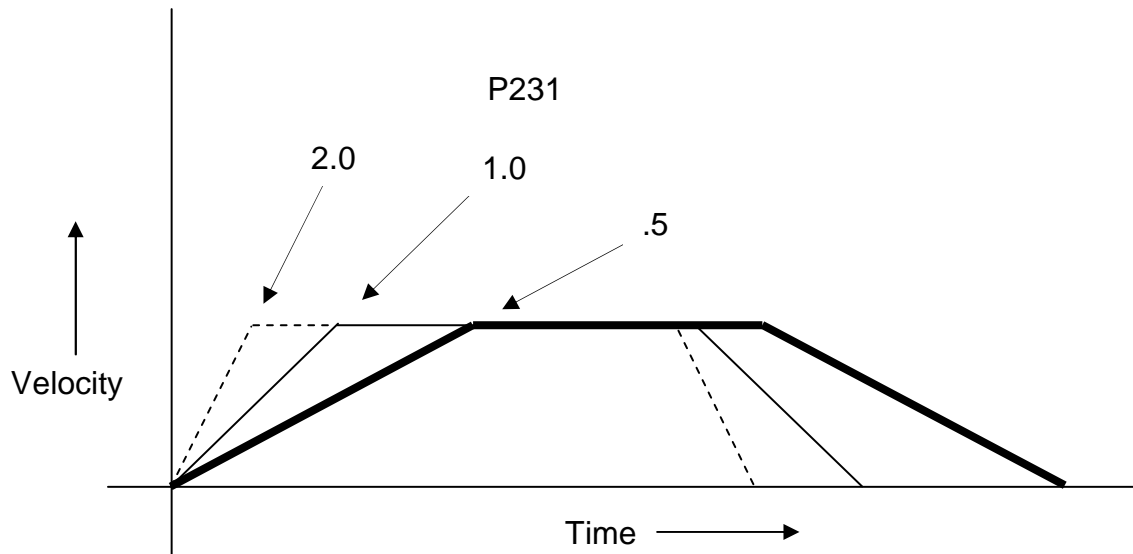

4. **Min_Angle (P227)** defines the minimum angle to apply Smoothing to. All angles below the minimum angle will be sharp. For example if Min Angle is set to 95deg then all angles less than 95 right angle (including 90deg) corners will be sharp (not smoothed).

Fig. 5 Min_Angle allows or inhibits smoothing

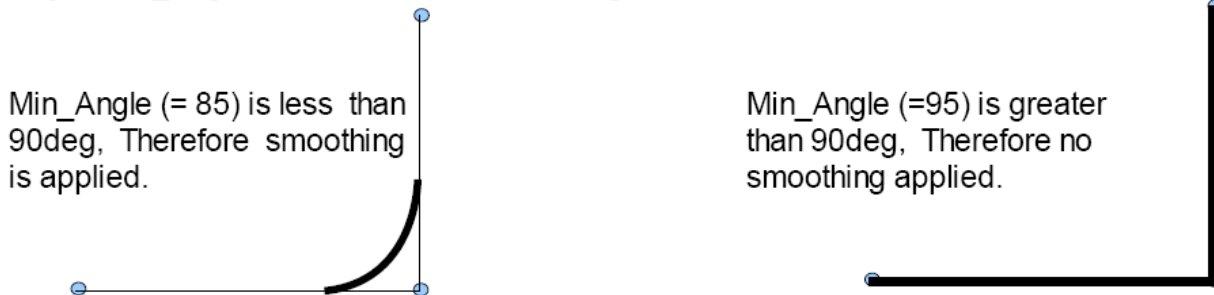

5. Feature width W (P226)

W and Min_Angle work together to determine which angles will be "sharp" (not be smoothed). For example a Gcode file may contain small spikes, double backs or zig zags of less 1mm that may be causing unwanted slowdowns in an otherwise high speed stretch of toolpath. Given a STEP (P222) = .25mm , setting W (P226)= 4 (4*.25=1mm) should reduce or eliminate decelerations across the problem toolpath. W does not itself smooth the offending data, that's the job of Smoothing (controlled by NBpts and STEP), but W does allow you to minimize slowdowns caused by small features, which is very helpful for running smooth thru jagged CAD/CAM generated G code.

Fig 6. W determines whether or not a feature is significant

Feature is larger than W x Step

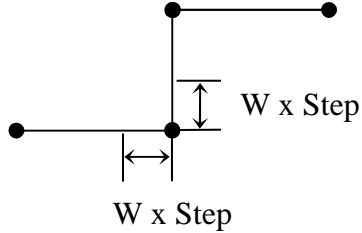

This feature is significant.

Therefore, if the feature's angles are less than Min_Angle (P227) they will be shapened. Otherwise, smoothing will be applied.

Feature is smaller than W x Step

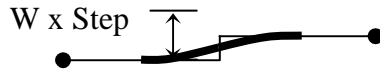

Because this feature is considered insignificant, smoothing will be applied over it.

Smoothing Setup Menu

Pressing **F8 – Smoothing Setup** from the Setup menu will bring up the Smoothing Setup Menu. The Smoothing Setup Menu provides a simplified way of choosing parameters for the Smoothing module. Smoothing is especially useful in controlling and minimizing the amount of banging a machine experiences as it proceeds along the toolpath. Smoothing is also able to (optionally) round part geometry, allowing for faster feedrates around corners.

WCS #1 (G54)		Current Position (Inches)		Job Name: flange.cnc	
X		+0.0000		Tool: T0 H0	
Y		+0.0000		Feedrate: 106% 0.0 ipm	
Z		+0.0000		Spindle: 0 A	
				9099 Message Cleared 406 Emergency stop detected	
				Press CYCLE START to start job	
Smoothing Setup Menu				Stall detection disabled	
Smoothing on/off:		ON		Smoothing is ON (P220) *	
Slower Curves		Faster Curves		Curve Feedrate Multiplier at 100% (P230)	
Round All		Sharpen All		Angles up to 95 degrees will be sharpened	
Gentler Stops		Faster Stops		Acceleration Multiplier at 100% (P231)	
Quick Setups					
* F2 Precision Mill is selected					
Exact Stop F1	Precision Mill F2	Contouring Mill F3	Precision Router F4	Contouring Router F5	Customize Presets F9
					Save F10

F1 will turn off Smoothing. The other quick setup keys **F2-F8** (if displayed) will turn on Smoothing and activate a smoothing preset profile by setting Parameter 220 to 1 and copying preset values from the selected preset into parameters 221-231.

By default the following 4 presets are provided:

F2 – Precision Mill Chooses Smoothing with settings for high precision work on a Mill.

F3 – Contouring Mill Chooses Smoothing with settings for a Mill, with looser tolerances for rounded geometry.

F4 – Precision Router Chooses Smoothing with settings for precision work on a Router.

F5 – Contouring Router Chooses Smoothing with settings for a Router, with looser tolerances for smooth geometry.

Presets can be modified, added, or removed by pressing **F9 – Customize Presets** which will give you access to the menu described in the next section.

Custom Smoothing Presets Menu

Pressing **F9** – **Customize Presets** from the Smoothing Setup menu will bring up the screen that allows you to customize the Quick Setups keys that appear in the Smoothing Setup menu.

WCS #1 (G54)	Current Position (Inches)	Job Name: flange.cnc
X 	+0.0000	Tool: TO H0
Y	+0.0000	Feedrate: 106% 0.0 ipm
Z	+0.0000	Spindle: 0 A
<div style="border: 1px solid black; padding: 5px;"> 9099 Message Cleared 406 Emergency stop detected </div>		
Press CYCLE START to start job		
Custom Smoothing Presets Menu		
	Preset #1 [F2]	Preset #2 [F3]
F-Key Label	Precision Mill	Contouring Mill
P221 (NBpts)	1.00000	10.00000
P222 (STEP)	0.00100	0.00200
P223 (Umax)	800.00000	800.00000
P224 (Centripetal)	0.00000	0.00000
P225 (Unused)	0.00000	0.00000
P226 (W)	10.00000	20.00000
P227 (Minimum Angle)	95.00000	1.00000
P228 (S curve)	0.00000	0.00000
P229 (Smoothing Backplot mode)	1.00000	1.00000
P230 (Curve Feedrate Multiplier)	1.00000	0.50000
P231 (Acceleration Multiplier)	1.00000	1.00000
	Prev F7	Next F8
		Save Presets F10

Smoothing presets #1 through #7 corresponds to **F2** through **F8** of the Smoothing Setup menu. Each Smoothing preset consists of a customizable F-key label and a customizable set of parameter values that will be copied to the actual parameters P221 through P231 when such a preset is selected in the Smoothing Setup Menu. Only those presets that have a non-blank F-key Label will be available in the Smoothing Setup Menu. To remove a particular preset from the Smoothing Setup Menu, simply delete its F-key Label and leave it blank.



WARNING

The Smoothing Presets should not be changed without consulting your dealer. Corrupt or incorrect values could cause damage to the machine, personal injury, or both.

Chapter 15

CNC Software Messages

CNC software startup errors and messages

Error	Message	Cause & Effect	Action
102	Error initializing CPU...cannot continue.	Error while sending <i>.hex</i> file. Cannot communicate with MPU11 or it is not plugged in.	Inspect MPU11 connection, or fix missing or corrupted hex file. Contact Dealer
103	Error sending setup	Unable to send setup command to MPU11. Cannot communicate with MPU11 or it is not plugged in.	Inspect MPU11 connection, or fix missing or corrupted hex file. Contact Dealer
104	Error sending PID setup	Unable to send PID setup command to MPU11. Cannot communicate with MPU11 or it is not plugged in.	Inspect MPU11 connection, or fix missing or corrupted hex file. Contact Dealer
105	<i>mpu.plc</i> file read error..cannot continue	Missing or error in <i>mpu.plc</i> .	Contact dealer Install or recompile PLC program.
106	The PC clock appears to be wrong	The time on the PC internal clock is earlier than the time recorded in a previously stored file	
199	CNC started	CNC control software has started.	

Messages issued upon exit from CNC software

Error	Message	Cause & Effect	Action
201	Exiting CNC due to a known error	MPU11 not responding, or <i>mpu11.hex</i> , <i>mpu.plc</i> is missing or damaged.	Contact dealer Check for possible software corruption
202	Exiting CNC due to a math error	A floating-point math error occurred. Possible corruption of <i>cnc.tem</i> , <i>cncm.job</i> , or <i>cncm.wcs</i> .	Contact dealer Delete corrupted files and reboot software.
204	Exiting CNC...Normal Exit	CNC control software is shutting down normally.	
222	Autotune run	added to log whenever autotune is run	

Messages and Prompts in the Operator Status Window Status messages

Error	Message	Cause & Effect	Action
301	Stopped	No operations in progress	
302	Moving...	Motors are moving while a CNC program is running	
303	Paused...	Motion is paused while a CNC program is running (FEED HOLD)	
304	MDI...	CNC software running in MDI mode	
305	Processing...	CNC software running in a mode other than MDI	
306	Job finished	Normal end of CNC program	

Error	Message	Cause & Effect	Action
307	Operator abort: job canceled	ESC or CYCLE CANCEL pressed. Job is cancelled.	
308	Waiting for input #NN	M100 or M101 executing. Program will continue once specified input opens or closes.	
309	Waiting for CYCLE START button	M0, M1, M100/75, or Block Mode is executed.	Press Cycle Start
310	Waiting for output #NN	M100 or M101 executing. Program will continue once specified output opens or closes.	
311	Waiting for memory #NN	M100 or M101 executing. Program will continue once specified memory bit changes to the correct state.	
312	Waiting for PLC operation (Mnn)	PLC program not clearing PLC operation in progress	
313	Waiting for dwell time	G4 executing. Program waits for specified dwell time then continues.	
314	Waiting for system #NN	M100 or M101 executing. Program will continue once specified PLC system variable changes to the correct state.	
315	Searching...	Run/search in progress	
317	Waiting for automatic tool change	mfunc6.mac executing	
318	Operator Abort probing cancelled	ESC or CYCLE CANCEL pressed while doing a probing move	
319	Probing cycle cancelled	probing cycle was cancelled	
320	Probe stuck	probe is stuck, or probe hit an object when it wasn't expecting contact.	
322	Stall: probing cancelled	probing was cancelled because of a stall	
323	Stall: job cancelled	job was cancelled because of a stall	
324	Limit: probing cancelled	probing was cancelled because of a limit error	
325	Limit: job cancelled	job was cancelled because of a limit error	
326	Fault: probing cancelled	probing was cancelled because of a fault	
327	Fault: job cancelled	job was cancelled because of a fault	
328	Cutter comp error: job cancelled	job was cancelled because of a cutter comp error	
329	Invalid parameter: job cancelled	job was cancelled because of an invalid parameter	
330	Canned cycle error: job cancelled	job was cancelled because of a canned cycle error	
332	Search Failed	Run/Search was unable to find the requested G-code line	
334	Locating position to resume job...	Run/Search is locating the job continuation point in the program	
335	Emergency Stop Released	Emergency Stop Button has been released	
336	Digitize cancelled	ESC or CYCLE CANCEL pressed during digitizing	
337	Digitize complete	A digitizing routine ran to completion	
338	Job Cancelled	ESC or CYCLE CANCEL pressed during job run	

Error	Message	Cause & Effect	Action
339	Jogging...	An axis jog key is pressed and machine is moving the corresponding axis	
340	Limit (#_) cleared	A previously tripped limit switch is now in the “untripped” position	
341	Probing Cycle Finished	A probing cycle ran to completion	
342	Waiting for motion to stop	PC is waiting for the MPU11 to complete motion	
343	Waiting for stop reason reset	PC is waiting for the MPU11 to reset the stop reason (as part of the PC/MPU11 communications handshake).	
344	Feedrate modified due to spindle	The effective feedrate has been lowered because the spindle is spinning slower than the threshold percentage of the commanded spindle speed. (The threshold percent is specified in P149.)	
345	Waiting for spindle to get up to speed	Job progress is paused until the actual spindle speed reaches the threshold percentage of the commanded spindle speed. (The threshold percentage is specified in P149.)	
346	Waiting for spindle direction	Job progress is paused until the spindle turns the commanded direction.	

Abnormal stops (faults)

Abnormal stops are detected in the following order: PLC, servo drive, spindle drive, lube, ESTOP. This means that if both the servo drive and the spindle drive have faulted, the servo drive fault message would appear.

Number	Message	Cause & Effect	Action
401	PLC failure detected	MPU11 stopped with PLC failure bit set. Job cancelled.	Check PLC fibers and PLC logic power.
404	Spindle drive fault detected	MPU11 stopped with spindle drive fault bit set. Job cancelled.	Check inverter for fault or reset spindle contactor OCR, then cycle EMERGENCY STOP
405	Lubricant level low	MPU11 stopped with low lube fault bit set. Current job will finish but nothing will work after that.	Add lube or check low lube switch wiring then cycle EMERGENCY STOP
406	Emergency Stop detected	MPU11 stopped with no fault bits set. Job cancelled.	Release Estop
407	limit (#_) tripped	MPU11 stopped with limit switch tripped. Job cancelled.	Clear limit switch
408	Programmed action timer expired	M103 time expired before M104 encountered. Job cancelled.	Find out why timer expired before specified action was completed.

Number	Message	Cause & Effect	Action
409	_ axis lag	<p>Lag Distance (Allowable Following Error) is detected on any axis for more than 1.5 seconds.</p> <p>All axis motion is stopped and the CNC program is aborted. The probable causes of this error are:</p> <ol style="list-style-type: none"> 1. The machine is doing a very heavy cut. 2. The maximum rates or the acceleration values for the motors are set too high. 3. The motors are undersized for the application 	<ol style="list-style-type: none"> 1. If the problem is occasional heavy cuts, slowing down the cutting feedrate can solve the problem. 2. If the problem only occurs on high speed moves then either the maximum speed or the acceleration is set too high. Lower the values in the Motor Setup screen or run Autotune again to determine new values. 3. If there are persistent lag errors in normal operations, this indicates that the motors are too weak to handle the required loads. Increase the gear ratios or get more powerful motors.
410	_ axis position error	<p>A position error > 0.25 inches is detected on any axis. All axis motion is stopped, power to the motors is released (all servo drive commands cease) and the CNC program is aborted.</p> <p>The probable causes of this error are:</p> <ol style="list-style-type: none"> 1. The motor is wired up backwards. 2. Noise is getting into the system via the motor cables (the line integrity has been violated). 3. An encoder error occurred. 	<ol style="list-style-type: none"> 1. Try to slow jog the motor and watch the DRO position. If the position on the DRO goes opposite the direction indicated on the jog button, then the motor is wired up backwards. Change the motor wiring. 2. Check the motor cabling paying particular attention to the ground connections. Replace the cable if it is damaged or repair the motor connections. 3. Jog the motor awhile, at the maximum rate, using the fast jog buttons. (Check the fast jog rate in the motor jog parameters screen to make sure it is set equal to the maximum motor rate.) If the motor seems to jump around rather than accelerate and decelerate smoothly then you are probably fighting an encoder error. Swap the motor with one from another axis and see if the error follows the motor. If it stays with the axis, replace the MPU11. If it follows the motor, replace the motor cable. If the problem still persists, replace the motor and encoder.

Number	Message	Cause & Effect	Action
411	_ axis full power without motion	<p>90% Power (PID Output > 115) is applied to any axis and no motion >0.0005 inches is detected, for more than the time specified in parameter 61 (default .5 sec.). All axis motion is stopped and the CNC program is aborted.</p> <p>The probable causes of this error are:</p> <ol style="list-style-type: none"> 1. One of the axes is against a physical stop. 2. The servo drive has shutdown due to a limit switch input. 3. The Z home switch is the same as the Z + limit switch. 	<ol style="list-style-type: none"> 1. If the axis has run into a physical stop, use the slow jog mode to move the axis away from the stop. Determine and set software travel limits to stop machine before in runs into the hard stops. 2. If the axis is not on a physical stop, check for a tripped limit switch. If it is then the software is commanding a move into the switch but the hardware is shutting the move down. Go to the motor setup screen and enter the limit switch input number if applicable. 3. Make sure the switch input is not unstable or noisy. If it is then replace the switch. If the problem persists it may be necessary to create separate home and limit switch inputs. <p>Use slow jog to move opposite the direction causing the error and clear all limit switches. Jog toward the direction causing the error, if no motion occurs then a servo drive failure is indicated.</p>
412	_ axis encoder differential error	An error condition was detected in the differential signal levels for this axis encoder. May indicate a loose or severed encoder cable or a bad encoder. This will stop all motion and cancel the job.	Reconnect/replace encoder or encoder cable.
417	Abnormal end of job	Job ended without reason.	
418	Search Line or Block not found	Requested search input data not found in loaded CNC file.	Type in correct data or load correct job.
419	Search line in embedded subprogram	Requested search line is found, but is part of an embedded/extracted subprogram	Use another line number
420	_ axis motor overheating	CNC software estimates that a motor has reached the warning temperature (set in Parameter 29). Motor is overheating or the temperature file is corrupted. Job will be cancelled.	Contact dealer. Determine what's causing motor to overheat or delete cnc.tem file and reboot.
421	Motor(s) too hot: job canceled	CNC software estimates that one or more motors have reached the limit temperature (set in Parameter 30). Will not be able to run until motor cools down.	Contact dealer. Determine what's causing motor to overheat or delete cnc.tem file and reboot.
422	Check Jog Panel cable	Jog panel failure or loose cable.	Reconnect jog panel cable.
428	Check MPG cable	MPG failure, loose cable, or was turned off.	Reconnect MPG cable and turn axis selector knob to an axis.
434	_ idling too high: Releasing power	Axis is not moving and no job is running but axis has stopped against some abnormal resistance. Power is released to motors.	Run an autotune to adjust motor settings.

Number	Message	Cause & Effect	Action
435	_ axis runaway: Check motor wiring	Motor was in a runaway fault condition. Power to motor will automatically be shut off.	Check motor wiring
436	Servo drive shutdown	This error message is produced by hardware detection of a physical error. The servo drive hardware generates this error message if it detects either an overcurrent or overvoltage condition. The particular hardware condition is reflected on the servo drive LED's. Once the servo drive detects this error condition it stops all motion and removes power to the motors. The hardware indicates the presence of this condition to the CNC software via the servo drive fault input to the PLC.	On DC systems check status of the servo drive LED's and check fibers 4&5. If this message is displayed on an AC system check P178 bit 4 is set.
437	Servo power removed	Axis was moving more than 300 RPM while power was supposed to be off. 1.) Motor may be wired backwards. 2.) May be a shorted servo drive. 3.) Axis motion is canceled but motor continues to move due to inertia, which is probably caused by an unbalanced axis. Power to motors is released.	Check motor wiring, servo drive, or look at Kg value in PID and make sure it's not above +/- 5.
438	Spindle slave position error	The slaved axis moved too far in the wrong direction during a spindle-slaved move (such as in rigid tapping). Job is cancelled.	Check parameter 34 for wrong sign in front of encoder counts.
439	_ axis servo drive data output error	Logic power failure or loss of communication from the drive to the MPU11.	Is logic LED on? Check fiber optic cables to drive. For SD1 drives, make sure bus cables are shielded and are as short as possible. Power unit down and check drive connections.
441	_ axis overvoltage	Input power has gone higher than 340VDC and will shutdown the drive and removes power. The motor brake will engage for 5 seconds in this condition.	Check input voltage is below 340VDC. If not, incoming VAC needs lowered.
442	_ axis undervoltage	Drive input power is less than 80 VDC.	Check supply voltage.
443	_ axis commutation encoder bad	Control detected invalid commutation zone value.	Perform a motor Move Sync in the Drive menu. A Zero (0) or Seven (7) is an invalid zone. Check for: a.) Wiring problem in the encoder cable or motor end cap (broken encoder wires). b.) Encoder cable shield connected at motor end, when it shouldn't be. c.) Bad encoder. d.) Motor power cable shields not connected. e.) Drive not grounded properly.

Number	Message	Cause & Effect	Action
444	_ axis overtemperature detected	Drive overtemp sensor tripped. No motor power.	The drive is being run at over capacity or the cooling fan is either not functioning or its air flow is blocked.
445	_ axis overcurrent detected	Overcurrent detected on an axis. No motor power.	Try to jog the axis. The drive will reset the current limit and try to move the motor. If the error comes back, check for a short in the motor output.
446	_ axis servo drive data input failure	Communication Checksum error. No motor power.	Check fiber optic cables. Verify continuity between drive chassis, ground strip and Earth ground.
447	_ axis (#) bad index pulse detected	Noise picked up by encoder cable or misaligned encoder. No motor power.	Remove noise or align the encoder.
449	Manual movement detected in restricted area	Detection for this condition is currently unimplemented.	This condition should not appear.
450	Voltage brake applied	Overvoltage condition was detected. Electronic braking was applied by offloading excess voltage to dropping resistors.	Usually this error condition is innocuous even if this message occurs every once in a while in a job. However, if this message occurs in a continuous stream, contact your dealer.
451	Current brake applied	Overcurrent spike was detected on the drive.	Usually this error condition is innocuous even if this message occurs every once in a while in a job. However, if this message occurs too often, it may mean you need a higher current drive. But, if this message appears in a continuous stream, something is seriously wrong, and you should hit E-Stop to cut power to the drive and then contact your dealer.
452	PC Receive Data Error	A fatal communication error occurred between the MPU and PC. The error was detected on the PC side.	Restart the software to clear the error. If this error occurs often there may be an issue with the network configuration or the Ethernet cable.
453	CPU Receive Data Error	A fatal communication error occurred between the MPU and PC. The error was detected on the MPU11 side	Restart the software to clear the error. If this error occurs often there may be an issue with the network configuration or the Ethernet cable.
453	Jogging while probe detected	The probe was in the tripped state while a jog key was pressed.	
454	axis scale encoder differential error	An error condition was detected in the differential signal levels for this axis scale encoder. May indicate a loose or severed encoder cable or a bad encoder. This will stop all motion and cancel the job.	Reconnect/replace scale encoder or scale encoder cable.
455	axis encoder quadrature error	The axis encoder skipped a transition state on its count-up/count-down sequence. May indicate a bad encoder or a loose or severed encoder cable. This will stop all motion and cancel the job.	Reconnect/replace encoder or encoder cable.

Number	Message	Cause & Effect	Action
456	axis scale encoder quadrature error	The scale encoder skipped a transition state on its count-up/count-down sequence. May indicate a bad encoder or a loose or severed encoder cable. This will stop all motion and cancel the job.	Reconnect/replace scale encoder or scale encoder cable.
457	Unable to find home	A commanded move was seeking either an index pulse or a hard stop, but neither was found.	Reconnect/replace encoder or encoder cable if move was seeking an index pulse. Check that hard stop was not broken off nor overrun.
459	TT1 or Probe is not connected	A Tool Measure operation aborted because the required TT1 or Probe is not connected.	Check TT1 or Probe wiring and plug.
460	TT1 and Probe are both connected	A Tool Measure operation aborted because both a TT1 and Probe were connected.	Make sure TT1 and Probe are not plugged in at the same time. Also check wiring.
461	Spindle axis is not set	An operation aborted because the spindle axis parameter (P35) has an incorrect value.	Contact dealer.
462	Triangular Rotary Axis Out of Range	A triangular rotary axis (on a tilt table or articulated head machine) is at a position which is out of range for angular calculation.	Contact dealer.
470	brake wattage exceeded	The brake wattage was exceeded on the indicated ACDC drive.	Contact dealer.
487	Invalid tilt table parameters	One or more values in the tilt table configuration is incorrect.	Contact dealer.

CNC syntax errors

Number	Message	Cause & Effect	Action
501	Invalid character on line NNNNN	Invalid character on CNC line. Job cancelled.	Remove character from program.
502	Invalid G code on line NNNNN	Invalid G code encountered on CNC line. Job cancelled.	Correct invalid G-code.
503	Invalid M function on line NNNNN	Invalid M function encountered on CNC line. Job cancelled.	Correct invalid M-code.
504	Invalid parameter on line NNNNN	Invalid or missing number after letter. Job cancelled.	Correct program.
505	Invalid value on line NNNNN	Value out of range (T, H, D). Job cancelled.	Correct program.
506	Only 1 M code per line	More than one M code appears on the line. Job cancelled.	Move 2 nd M-code to next line.
507	No closing quote	The closing quotation mark (") is missing. Job cancelled.	Add quotation.
508	Macro nesting too deep	Macro nesting limit exceeded on attempt to invoke a subroutine. Job cancelled.	Create a second program.
509	Option not available	Attempt to access a locked software option. Job cancelled.	Contact Dealer.
510	Too many macro arg's	Too many arguments were given in a G65 macro. Job cancelled.	Correct number of arguments.

Number	Message	Cause & Effect	Action
511	Missing parameter	A parameter is required or expected but not found. Job cancelled.	Correct program.
513	Expected “=”	Error in expression to left of “=”, missing “=”, or orphaned parameter. Job cancelled.	Correct equation.
514	Empty expression	The expression contains no operands. Job cancelled.	Correct expression.
515	Syntax error in expression	Illegal character in number, variable or function. Job cancelled.	Correct program.
516	Unmatched bracket (parenthesis)	Brackets or parentheses are paired improperly or misplaced. Job cancelled.	Correct program.
517	Evaluation stack overflow	Brackets or parentheses are nested too deeply. Job cancelled.	Correct program.
518	Undefined variable	The variable name does not exist. Job cancelled.	Correct program.
519	Too many variables	The space allotted for user-defined variables has been exceeded. Job cancelled.	Correct program.
520	Invalid variable name	The variable name contains an illegal character. Job cancelled.	Correct program.
521	Divide by zero	Attempt to divide by zero. Job cancelled.	Correct program.
522	Domain error	Imaginary number would result (square root of a negative number). Job cancelled.	Correct program.
523	Invalid value in assignment	Attempt to assign an illegal value to a system variable. Job cancelled.	Correct program.
524	Variable is read-only	Attempt to assign a value to a read-only system variable. Job cancelled.	Correct program.
525	Missing P value	P parameter is expected but is missing	Correct program.
526	M22x Missing initial variable	M224 or M225 was not immediate followed by a #variable reference.	See Chapter 13 for syntax of M224 or M225
527	M22x initial variable parse error	M224 or M225 was immediate followed by an invalid #variable reference.	Correct program.
528	M225 String variable not allowed	M225 was immediately followed by a string #variable (which is invalid). Only numeric variables are allowed here.	Correct program.
529	M225 invalid variable	The #variable specified after the M225 was not valid, or not readable due to a machine error.	Correct program.
530	M224 invalid variable	The #variable specified after the M224 was read-only, or not writeable due to a machine error.	Correct program.
531	M22x missing initial quote	The beginning of the quoted (“) format string was not found or was in the wrong place on the G-code line.	See Chapter 13 for syntax of M200, M223, M224 or M225
532	M22x missing end quote	The format string did not end with a quote (”)	See Chapter 13 for syntax of M200, M223, M224 or M225
533	M22x embedded quote not allowed	The format string contained a quote (“) in the middle of it.	See Chapter 13 for syntax of M200, M223, M224 or M225
534	M22x character limit exceeded	The format string was too long	Correct program.
535	M22x invalid format string	The format string contained invalid format codes	Correct program.

Number	Message	Cause & Effect	Action
536	M22x missing format specifier	The format code was missing the its specifier	Correct program.
537	M22x Missing Argument	A format code was specified in the format string, but its corresponding #variable argument was missing	Correct program.
538	M22x argument parse error	A format code was specified in the format string, but its corresponding #variable argument had a syntax error	Correct program.
539	M22x variable type mismatch	A string format code was specified in the format string, but its corresponding #variable argument was numeric OR a numeric format code was specified in the format string, but its corresponding #variable argument was a string	Correct program.
540	M22x variable cannot be read	A format code was specified in the format string, but its corresponding #variable argument was invalid or there was a machine error when accessing it.	Correct program.
542	M22x character limit exceeded	The resultant formatted string after all the format codes were processed was too long.	Correct program.
543	Missing L parameter	L code was missing	Correct program.
544	Too many axes	More than 1 axis was specified with M128, OR the Simultaneous Contouring feature is not enabled. Without the Simultaneous Contouring feature, a maximum of 3 axes are allowed per G-code line.	Specify fewer axes on the G-code line OR Contact Dealer for information about obtaining the Simultaneous Contouring feature.
545	Value out of range	Parse error occurred because value was out of range	Correct the value
547	Move by counts not allowed	Cutter comp (G41/G42) was on when M128 was specified	Issue G40 (Cutter comp off) before issuing M128
548	String too long	A quoted string was too long (usually a file name was longer than its allowed limit).	Shorten the file name.
549	Line too long	A line in a G/M-code program is too long (more than 1023 characters).	Shorten the line.
550	Invalid L parameter	The value associated with the L code is invalid	Give the correct value.
551	Invalid R value	The value associated with the R code is invalid	Give the correct value.
552	File encryption error	Error while parsing encrypted G-code file.	

Cutter compensation errors

Number	Message	Cause & Effect	Action
601	Error: no compensation in MDI	G41 or G42 entered in MDI. MDI is not canceled, but cutter compensation does NOT go into effect. Remainder of line processed.	Do not use G41 or G42 in MDI.
603	Arc as first uncomp. move on line NNNNN	Arc specified as first move after end of compensation (G40). Job cancelled.	First move after G40 must be a linear move.
604	Plane must be XY on line NNNNN	Cutter compensation started with YZ or ZX plane selected. Job cancelled.	Remove cutter comp. for YZ or ZX plane moves, option is not available.

Number	Message	Cause & Effect	Action
605	Canned cycle not allowed on line NNNNN	Canned cycle attempted during compensation. Job cancelled.	Do not use cutter comp. with canned cycles.
606	G53 not allowed on line NNNNN	G53 attempted during compensation. Job cancelled.	Choose a different work coordinate.
607	Set home not allowed on line NNNNN	M26 attempted during compensation. Job cancelled.	Do not use M26 with cutter comp.
608	Ref. point move not allowed on line NNNNN	G28, G29, or G30 attempted during compensation. Job cancelled.	Do not use return points with cutter comp.

Parameter setting errors

Number	Message	Cause & Effect	Action
701	G10 error: no R-value on line NNNNN	G10 used with no R-value. Job cancelled.	Input an R-value.
702	G10 error: invalid D on line NNNNN	Job cancelled (D0 cannot be set; it is always zero).	Change D to a valid value.
703	G10 error: invalid H on line NNNNN	G10 H0 Rxx specified. Job canceled (H0 cannot be set; it is always zero).	Change H to a valid value.
704	G10 error: invalid P on line NNNNN	G10 used with unknown P value. Job cancelled.	Change P to a valid value.
705	G10 error: No D, H, or P on line NNNNN	G10 used without D, H, or P to assign value. Job cancelled.	Add appropriate D, H, or P value.

Canned cycle errors

Number	Message	Cause & Effect	Action
801	Error: No R point on line NNNNN	No R-value specified. Job cancelled.	Add an R-point.
802	Error: Q = 0 on line NNNNN	Q value of 0 specified (Q used for G73 and G83 only). Job cancelled.	Insert a Q non-zero value.
803	Error: No Z point on line NNNNN	No Z value specified for canned cycle. Job cancelled.	Add a Z-value.
804	Error: Ggg invalid on line NNNNN (gg = 76, 86, 87, 88)	Unimplemented canned cycle requested. Job cancelled.	Change to a valid G-code.
805	Error: No Q value on line NNNNN	Q value not specified for G73 or G83. Job cancelled.	Insert a Q-value.
806	Error: No P value on line NNNNN	P value (dwell time) not specified for G82 or G89. Job cancelled.	Add a P-value.
807	Error: Cannot execute G__ when axis B is rotated	On an Articulated Head machine with TWCS feature enabled, a non-compound canned cycle (such as G73, G74, G76, G80, G81, G82, G83, G84, G85, G89) was issued on a WCS that was set to TWCS=No while the spindle head was tilted (i.e. rotary B axis was not 0). Job cancelled.	Either move B to 0 or issue the compound canned cycle version of the erroneous G-code such as G173, G174, G176, G181, G182, G183, G184, G185, G189.

Miscellaneous errors / messages

Number	Message	Cause & Effect	Action
901	Ref. point invalid on line NNNNN	G30 with invalid P value (must be 1 or 2). Job cancelled.	Change P-value to a 1 or 2.
902	No prior G28 or G30 on line NNNNN	G29 with no preceding G28 or G30.	Add a G29 or G30.
903	Warning: No coordinates for G92 on line NNNNN	G92 with no axis coordinates to set. Remainder of line processed; job continues.	Add coordinates.
905	Warning: 0 radius arc on line NNNNN	Arc move was specified with a zero radius. Move is done as a linear move; job continues.	Specify a radius.
906	Warning: unknown arc on line NNNNN	Position of arc move could not be determined from parameters (e.g. G91 G2 X0 Y0 R1). Move is done as a linear move; job continues.	Correct program.
907	_ axis travel exceeded on line NNNNN	Software travel limit would be exceeded by the requested move. Job cancelled.	Check program, part zero or tool offset.
909	Program too long: job canceled	Attempt to run a job over 1MB in length, without the unlimited program size option. Job cancelled.	Contact Dealer or break up program.
910	No subroutines in MDI	Specified O9100 - O9999 in MDI, which would begin an embedded subprogram. MDI cancelled.	
911	Illegal recursion	Attempt to execute a subprogram or macro that calls itself, either directly or indirectly. Job cancelled.	Call correct subprogram.
913	Could not open file <i>filename.ext</i>	Attempt to call a subprogram or macro, but the subprogram file does not exist. Job cancelled.	Make sure file name is correct and is in the ncfiles directory.
915	DSP window retry sN fN rN	DSP window checking failed, move will be repeated unless the maximum retries have been reached, s = number of successes, f = number of failures, r = number of times the maximum retry value has been reached	
916	Unexpected probe contact	probed tripped when a cycle did not expected contact	
917	Invalid tilt lookup table	The tilt lookup table file (tilt.tab) has an invalid format or if it is not found	
918	Probe unable to detect surface	Probe travelled maximum distance without contact, dsp window checking failed, or probe repeatability failed.	
919	DSP window failed maximum retries	DSP probe reached the maximum retry limit without a successful window	
920	Unable to clear obstacle	Probing cycle failed to clear an obstacle	
921	Unable to determine corner	Probing cycle failed to find corner (inside and outside corner)	
922	Out of memory	problem allocating memory	
923	Error: Z home not set	Z home is not set	

Number	Message	Cause & Effect	Action
924	File read error	Problem reading the job file, this error occurs if the file was opened successfully but there was an error while reading the file.	
925	Error reading job file	same as above at a different place in the code	
926	Failed to locate job continuation position	Job continuation from the Run Menu failed.	Do a Run/Search
927	Too many subprogram calls	Nesting level of subprograms is too high. I.e. a subprogram calls another subprogram which calls another subprogram, which calls another subprogram, etc...	
928	Error Loading Log Configuration file... Using defaults	There was an error while loading the log configuration file. Default settings will be used.	
929	Log Level set to __	The logging level parameter (P140) has been changed.	
930	Log Level Configuration file not found... Creating new configuration.	The log level configuration file was not found. A default file will be created.	
932	Error during Tool Check	A general error condition occurred when the Tool Check key was pressed.	
933	Log file initialized	There was an error in trimming the log file, or the log file did not exist, so a new log file has been created.	
934	Warning: Excess precision truncated	A CNC program is using axis positioning precision greater than what is displayed, and therefore the actual commanded positions are truncated. This happens when the Simultaneous Contouring feature was not enabled. This feature must be enabled for the extra precision to be acknowledged.	Contact Dealer for information about obtaining the Simultaneous Contouring feature.
935	_ axis (#) scale disabled	A scale is enabled for this axis but compensation was disabled. Scale compensation is disabled at initial power up, configuration changes, and during homing moves.	Home the machine.
935	Probe failed reset retries	Probe failed to reset after 3 tries. The probing operation may have been started too close to the surface.	Move probe further away from surface and do probing operation again. If this continues to fail persistently, call dealer.
936	_ axis (#) scale enabled	A scale is enabled for this axis and compensation was enabled. This happens after homing the axis.	Not Applicable
936	Probe failed to reset	Probe failed to reset. The probing operation may have been started too close to the surface.	Move probe further away from surface and do probing operation again. If this continues to fail persistently, call dealer.
944	MPU requested resend	The MPU requested a resend	Status Message
945	PC requested resend	The PC requested a resend	Status Message

Number	Message	Cause & Effect	Action
946	PC resending	The PC is resending	Status Message
947	PC received data out of order	The PC needed to reorder data received from the MPU	Status Message
948	PC packet error	The PC received bad data from the MPU and will try to recover by requesting a resend.	Status Message
949	Drive map does not match hardware	One or more of the drive mapping parameters 300-307 is misconfigured	Contact Dealer.

Scaling/Mirroring errors

Error	Message	Cause & Effect	Action
1001	Invalid scaling parameter on line NNNNN	Invalid parameter specified (I, J, K, P). Job cancelled.	Remove or change invalid parameter.
1002	Invalid scaling center on line NNNNN	Invalid parameter specified (X, Y, Z). Job cancelled.	Remove or change invalid parameter.
1003	G-code not allowed when scaling on line NNNNN	G28/G29/G30/G92 is not allowed when scaling or mirroring is turned on. Job cancelled.	Move G-code to appropriate line.
1004	Turn scaling off before rescaling	Tried to rescale while scaling is turned on. Job cancelled.	Turn scaling off, then rescale.
1005	Cannot scale arcs with different scale factors	Scaling factors of the arc axes are different. Job cancelled.	Correct scaling factors, or separate scaling operations.
1100-1199	Custom messages defined in <i>cnxmsg.txt</i> . Please contact your dealer if you have any questions regarding a particular message. This style of message should be replaced with <i>plcmmsg.txt</i> format on MPU11 systems.		

Configuration Modification messages

Number	Message	Cause & Effect
111	___ modified: __ -> __	An axis configuration parameter was modified.
444	__ modified: __ -> __	A servo drive configuration parameter was modified.
555	__ modified: __ -> __	A PID configuration parameter was modified.
556	Axis __ converted: __ -> __	A PID configuration parameter was converted.
777	__ modified: __ -> __	An axis configuration parameter was modified.
888	G30 Z modified: __ -> __	Z coordinate of Secondary Reference Point was modified.
999	Parm #__ modified: __ -> __	A machine parameter was modified.