

PLCEXP1616 User Guide

For Revision 221109

11/18/24

Overview

The PLCEXP1616 is a PLC expansion board used to add digital inputs and outputs to controls supporting the SCOUT protocol. The PLCEXP1616 has 16 relay outputs and 16 optically isolated inputs.

PLCEXP1616 Features

Application:	PLC Expansion Board
Digital Inputs:	16
Digital Outputs:	16
Control Interface:	SCOUT Protocol over RJ45 Cable
Update Rate:	4000 Hz
Dimensions (W*D*H):	9.8 * 4 * 0.75 inches

PLCEXP1616 Connection Overview

The PLCEXP1616 communicates with a MPU12 generation control board (REDOAK or ACORN_6) through an RJ45 / Ethernet cable connected to an accessory port. Typically, ACORN_6 has one accessory port available. In special cases, ACORN6EXP expansion board may be added to ACORN_6, giving a total of five expansion ports.

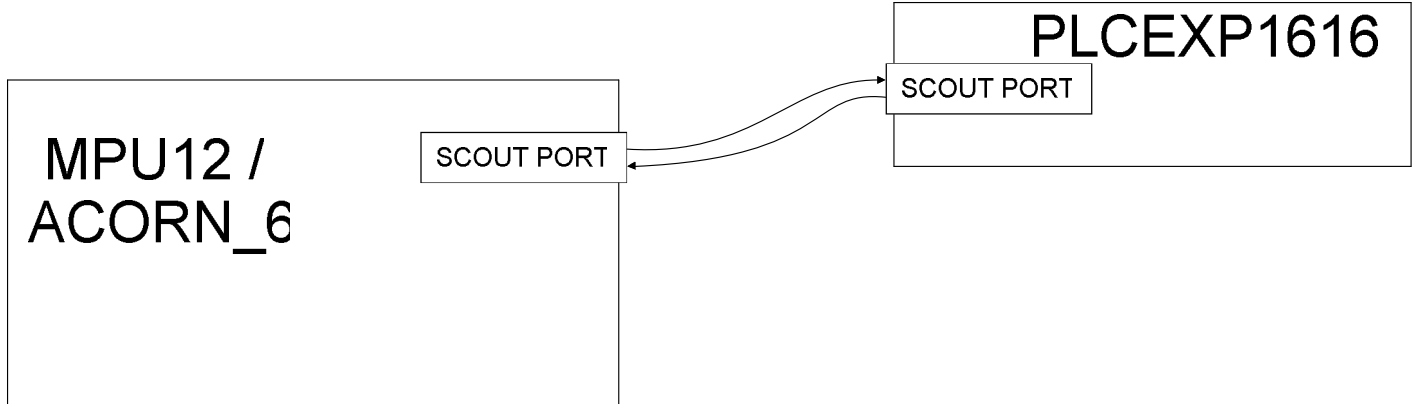

PLCEXP1616 Power

PLCEXP1616 logic is normally operated from power supplied by H7. An additional +24V supply can be connected to H6 "EXT +24VDC" and "GND" pins. This may be useful if there is significant voltage drop due to a long run of cable to H7.

PLCEXP1616 Outputs

Sixteen relay outputs are available on the PLCEXP1616. Two of the outputs have both normally open and normally closed connections. All relay coils will release if the PLCEXP1616 detects a communication error.

PLCEXP1616 Internal Circuitry

SPST Relay Output

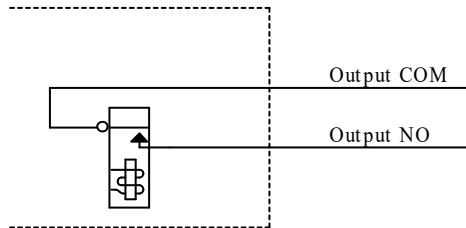

PLCEXP1616 Internal Circuitry

SPDT Relay Output

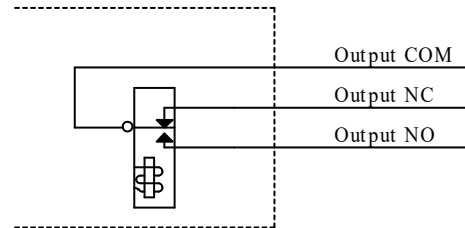

PLCEXP1616 Inputs

The PLCEXP1616 has 16 optically isolated inputs. Inputs are divided into banks of four. Each bank is configurable for various voltages and sinking or sourcing polarity. Voltage may be selected by installing the appropriate value resistor pack or SIP into a socket for each bank. Without a SIP installed, input voltage is set to 24V. Optional SIPs may be installed to use 12V or 5V input voltage. Polarity is determined by wiring the common terminal for the bank to the supply positive or supply common.

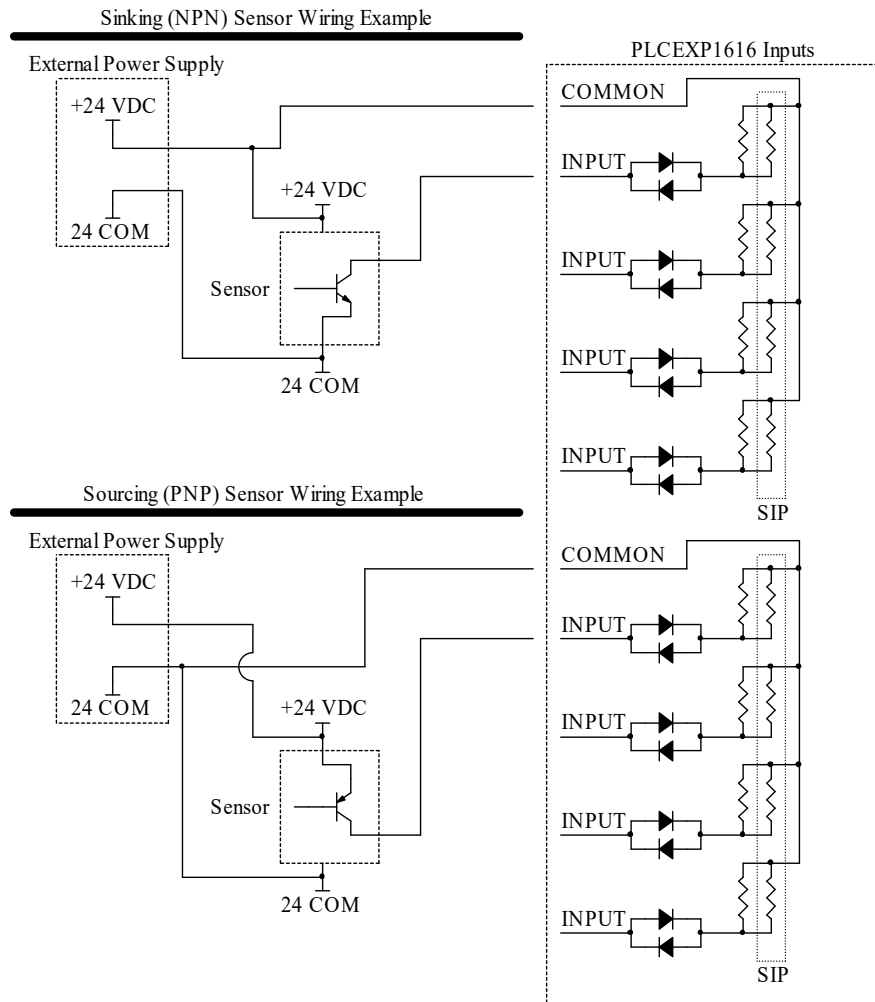

SIP Identification - XXX Indicates Value

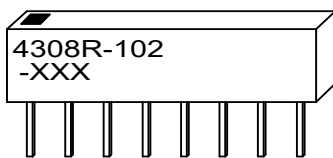

SIP Internal Wiring / Pinout

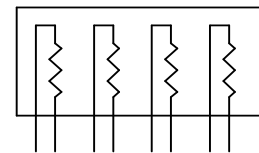

SIP Input Voltage Selection

SIP Value Marking	Resistor Value (Ohms)	Input Voltage
221	220	5
102	1.0k	12
None	None	24

PLC Communication

Communication with the MPU12 is performed through H7 RJ45 connector. See the ACORN_6 or applicable control board documentation to determine the where I/O from the PLCEXP1616 will be located. PLCEXP1616 requires one slot of input and output space. I/O update rate is 4000 times per second or once every 250us.

H7 Connector Pinout

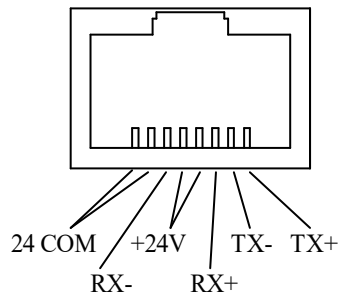

PLCEXP1616 I/O Map

Input Map

Input Specification			Input Location	
Number	Function	Type	Connector	Pin
1	General Purpose	Configurable	H5	1
2	General Purpose	Configurable	H5	2
3	General Purpose	Configurable	H5	3
4	General Purpose	Configurable	H5	4
5	General Purpose	Configurable	H5	6
6	General Purpose	Configurable	H5	7
7	General Purpose	Configurable	H5	8
8	General Purpose	Configurable	H5	9
9	General Purpose	Configurable	H4	1
10	General Purpose	Configurable	H4	2
11	General Purpose	Configurable	H4	3
12	General Purpose	Configurable	H4	4
13	General Purpose	Configurable	H4	6
14	General Purpose	Configurable	H4	7
15	General Purpose	Configurable	H4	8
16	General Purpose	Configurable	H4	9

Output Map

Output Specification			Output Location	
Number	Function	Type	Connector	Pin
1	General Purpose	Relay SPST	H1	1,2
2	General Purpose	Relay SPST	H1	3,4
3	General Purpose	Relay SPST	H1	5,6
4	General Purpose	Relay SPST	H1	7,8
5	General Purpose	Relay SPST	H1	9,10
6	General Purpose	Relay SPST	H1	11,12
7	General Purpose	Relay SPST	H1	13,14
8	General Purpose	Relay SPDT	H1	15,16,17
9	General Purpose	Relay SPDT	H1	18,19,20
10	General Purpose	Relay SPST	H2	1,2
11	General Purpose	Relay SPST	H2	3,4
12	General Purpose	Relay SPST	H2	5,6
13	General Purpose	Relay SPST	H2	7,8
14	General Purpose	Relay SPST	H2	9,10
15	General Purpose	Relay SPST	H2	11,12
16	General Purpose	Relay SPST	H2	13,14

PLCEXP1616 Specifications

Characteristic	Min.	Typ.	Max.	Unit
5 Volt Input Off	-	-	1.8	V
5 Volt Input On	4.1	-	-	V
12 Volt Input Off	-	-	3.5	V
12 Volt Input On	10.3	-	-	V
24 Volt Input Off	-	-	5.9	V
24 Volt Input On	24	-	-	V
Supply Voltage	22	24	25	V
Supply Current	0.275	-	-	A
Input Pullup Voltage (V _{inp})	4.5	24	26	V
Input Operating current	9	14	20	mA
Relay Output Current	0.1	-	10	A @ 125VAC
Relay Output Current	0.1	-	5	A @ 30VDC
RJ45 Cable Length	-	-	100	Feet
Size: 9.8 * 4 * 0.75 (W*D*H)				Inches

* Inputs may be wired either polarity. Input "on" and "off" ratings in the chart refer to the absolute difference between the input terminal and common terminal. Input devices must meet these specifications for long term reliability.

PLCEXP1616 Troubleshooting

Symptom	Possible Cause	Corrective Action
LED1 out	Power loss	Check RJ45 cable to H7
Input doesn't work with sensor	Incorrect wiring	Correct wiring for sensor type (sinking or sourcing), check that SIP values are appropriate for the input voltage
	Voltage drop across sensor is too high	Use 3-wire sensors with lower voltage drop spec.

LED1 Error Codes

Error Number	Meaning	Cause	Corrective Action
1	Communication Failure	Communication with host lost	Check RJ45 cable to H7
2			
3			
4			
5			
6	voltage failure	Power was lost	If error appears briefly at startup, it is normal, otherwise check for loose power connections
		Voltage < 18V	Make sure power supply amperage is adequate to power all connected accessories
7	Communication out of sync	Data in and out are not locked together in a synchronous relationship	Check RJ45 cable routing and move away from noisy or high power wires
8			
9			

PLCEXP1616 Connections and Mounting Dimensions

